

Soundcraft®

SI EXPRESSION

User Guide v2.0

For Soundcraft Si Expression 1, 2 & 3
Incorporating Software version 1.6



Soundcraft®
by HARMAN

Supplied by:

lightmoves

Melbourne
03 9701 2500

Sydney
02 9737 8988

info@lightmoves.com.au

www.lightmoves.com.au

INFORMATION

**IMPORTANT**

Please read this manual carefully before using your mixer for the first time.

This equipment complies with the EMC directive 2004/108/EC and LVD 2006/95/EC.

This product is approved to safety standards:

IEC 60065:2005 (Seventh Edition) +A1:2005

EN60065:2006 +A1:2006 +A1:2008

UL60065 2012 7th Edition

CAN/CSA-E60065-03 + A1: 2006

And EMC standards

EN55103-1: 2009 (E2)

EN55103-2: 2009 (E2)

Warning: Any modification or changes made to this device, unless explicitly approved by Harman, will invalidate the authorisation of this device. Operation of an unauthorised device is prohibited under Section 302 of the Communications act of 1934, as amended, and Subpart 1 of Part 2 of Chapter 47 of the Code of Federal Regulations.

NOTE: This equipment has been tested and found to comply with the limits for a Class B digital device, pursuant to Part 15 of the FCC Rules. These limits are designed to provide reasonable protection against harmful interference in a residential installation. This equipment generates, uses and can radiate radio frequency energy and, if not installed and used in accordance with the instructions, may cause harmful interference to radio communications. However, there is no guarantee that interference will not occur in a particular installation. If this equipment does cause harmful interference to radio or television reception, which can be determined by turning the equipment off and on, the user is encouraged to try to correct the interference by one or more of the following measures:

- * Reorient or relocate the receiving antenna
- * Increase the separation between the equipment and the receiver
- * Connect the equipment into an outlet on a circuit different from that to which the receiver is connected.
- * Consult the dealer or an experienced radio/TV technician for help.

For further details contact: Harman International Industries Ltd, Cranbourne House, Cranbourne Road, Potters Bar, Hertfordshire EN6 3JN, UK. Telephone +44 (0)1707 665000 Fax: +44 (0)1707 660742 email: soundcraft@harman.com

© Harman International Industries Ltd. 2014 All rights reserved
Parts of the design of this product may be protected by worldwide patents.
Part No. 5050549
Rev 1.0
E&OE September 2014

Soundcraft is a trading division of Harman International Industries Ltd. Information in this manual is subject to change without notice and does not represent a commitment on the part of the vendor. Soundcraft shall not be liable for any loss or damage whatsoever arising from the use of information or any error contained in this manual. No part of this manual may be reproduced, stored in a retrieval system, or transmitted, in any form or by any means, electronic, electrical, mechanical, optical, chemical, including photocopying and recording, for any purpose without the express written permission of Soundcraft.

Harman International Industries Limited
Cranborne House, Cranborne Road, Potters Bar, Hertfordshire, EN6 3JN, UK
Tel: +44 (0)1707 665000
Fax: +44 (0)1707 660742
<http://www.soundcraft.com>

CONTENTS**1.0 AN INTRODUCTION TO Si EXPRESSION**

- 1.1: Safety
- 1.2: Warranty
- 1.3: Specifications

2.0: GETTING STARTED

- 2.1: Console Overview
- 2.2: Parts Of The Console
- 2.3: FaderGlow

3.0: ASSIGNABLE CONTROLS

- 3.1: Fader Layers
- 3.2: Control Channels
 - 3.2.1: Control Channel Assignment
- 3.3: Global Mode Encoders
- 3.4: Assignable Channel Strip
- 3.5: tOTEM (Fader Follow)

4.0: TOUCH SCREEN OPERATION

- 4.1: Main Menu

5.0: INPUTS & OUTPUTS

- 5.1: Patching
 - 5.1.1: Soundweb Patching/Control
- 5.2: Default Patching
- 5.3: ViSi Connect I/O (Option Cards)
 - 5.3.1: Option Cards
 - 5.3.2: Stageboxes

6.0: CHANNELS & BUSSES

- 6.1: Input Channels
 - 6.1.1: Input Setup
- 6.2: Mix Outputs
 - 6.2.1: Mix Outputs Setup
- 6.3: Matrix Outputs
 - 6.3.1: Matrix Outputs Setup
- 6.4: Main Mix Outputs
 - 6.4.1: Main Mix Outputs Setup
- 6.5: FX Busses

7.0: DSP ELEMENTS

- 7.1: Function Focus
- 7.2: ACS / Channel Strip Elements
 - 7.2.1: ACS Input
 - 7.2.2: ACS Gate
 - 7.2.3: ACS Compressor
 - 7.2.4: ACS Equaliser
 - 7.2.5: ACS Output
- 7.3: Control Channel
- 7.4: Graphic EQ (GEQ)

8.0: MIX FEATURES

- 8.1: Mute Groups
- 8.2: Copy And Paste
- 8.3: Audio Interrogate
- 8.4: Solo System
- 8.5: Monitoring
- 8.6: CLR & ALT + CLR

9.0: SHOWS, CUELISTS, AND SNAPSHOTS

- 9.1: Shows
- 9.2: Cuelist & Snapshots
 - 9.2.1: Edit Cue

10.0: LEXICON FX

- 10.1: Reverbs
 - 10.1.1: Reverb Parameters
- 10.2: Delays
 - 10.2.1: Delay Parameters
- 10.3: Misc FX
 - 10.3.1: Misc FX Parameters

11.0: PREFERENCES, SYSTEM, SECURITY

- 11.1: Preferences
- 11.2: System Settings
- 11.3: Security Settings
 - 11.3.1: Add/Edit User
 - 11.3.2: Profiles
- 11.4: Software Updates
- 11.5: Reset Console

12.0: OSCILLATOR**APPENDIX 01: NO SOUND?**

A Trouble Shooting Guide.

*For clarity, this manual uses section references rather than page numbers.
In some instances, one section reference may extend to several pages.*

INTRODUCTION TO EXPRESSION

The Soundcraft Si Expression is a compact digital console optimised for live sound. It is designed to be powerful, yet simple to use, with intuitive controls, consistent colour-coded feedback, and rapid parameter access. Features such as motorised faders, the Assignable Channel Strip (ACS) and tOTEM Fader Follow buttons mean that any aspect of your mix can be served to the surface in an instant, with analogue-style control of its comprehensive feature-set.



- Recallable GB mic inputs with locking connectors and phantom power indicators.
- 4 Balanced-Jack line ins, 16 XLR analogue line outs, AES in and out, Wordclock, MIDI, Headphones out.
- HiQnet Ethernet Port and compatibility (Venue Events, Soundweb Control).
- 64 in x 64 out option card slot fully compatible with all ViSi Connect series cards and Soundcraft Stageboxes.
- Up to 66 channels to mix (54 Mono input channels, 6 Stereo input channels).
- Soundcraft 4-band British EQ on all inputs and outputs.
- Soundcraft Dynamics available on all channels.
- Delay available on all channels.
- BSS™ Graphic EQ on all Mix, Matrix, and Main Bus Masters.
- Quad Lexicon™ FX processors.
- Fader Glow™ illumination on all faders for at-a-glance display of current fader function.
- D.O.G.S. (Direct Out Gain Stabiliser) technology.
- tOTEM™ (The One Touch Easy Mix) system for 'Fader Follow' functionality for all Mix, Matrix, and FX Send busses -

create mixes quickly and easily.

- Assignable Control Strip (ACS) for instant access to all channel parameters.
- Colour touch screen interface for patching, routing, show set-up and security settings.
- Versatile Global Mode Encoders for flexible control.
- Comprehensive Show, Snapshot, and Cuelist system with USB storage.
- 4 user-assignable fader layers.
- 4 Matrix mixes that can operate in mono or stereo.
- 14 Aux-style Mix Busses, 6 of which can operate in mono or stereo.
- 4 Mute Groups.
- Comprehensive input, output, gain reduction and status metering/monitoring.
- Independent Main Mono and Left/Right busses.
- Ultra hard-wearing, polycarbonate-covered control surface resists wear and tear.
- 12V Lamp Connector.

SAFETY NOTICES

For your own safety and to avoid invalidation of the warranty please read this section carefully.

Important Symbols

**Cautions**

Alerts the user to the presence of important operating and maintenance (servicing) instructions in the literature accompanying the appliance.

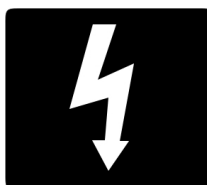
**Warnings**

Alerts the user to the presence of uninsulated 'dangerous voltage' within the product's enclosure that may be of sufficient magnitude to constitute a risk of electric shock to persons.

**THIS UNIT MUST BE EARTHED**

Under no circumstances should the mains earth be disconnected from the mains lead.

The wires in the mains lead are coloured in accordance with the following code:

Earth: Green and Yellow (Green/Yellow - US)
Neutral: Blue (White - US)
Live (Hot): Brown (Black - US)

As the colours of the wires in the mains lead may not correspond with the coloured markings identifying the terminals in your plug, proceed as follows:

The wire which is coloured Green and Yellow must be connected to the terminal in the plug which is marked with the letter E or by the earth symbol.

The wire which is coloured Blue must be connected to the terminal in the plug which is marked with the letter N.

The wire which is coloured Brown must be connected to the terminal in the plug which is marked with the letter L.

Ensure that these colour codings are followed carefully in the event of the plug being changed.

This unit is capable of operating over a range of mains voltages as marked on the rear panel.

The internal power supply unit contains no user serviceable parts. Refer all servicing to a qualified service engineer, through the appropriate Soundcraft dealer.

WARNINGS

- **Read** these instructions.
- **Keep** these instructions.
- **Heed** all warnings.
- **Follow** all instructions.
- **Clean** the apparatus only with a dry cloth.
- **Do not** install near any heat sources such as radiators, heat resistors, stoves, or other apparatus (including amplifiers) that produce heat.
- **Do not** block any ventilation openings. Install in accordance with the manufacturer's instructions.
- **Do not** use this apparatus near water.
- **Do not** defeat the safety purpose of the polarized or grounding type plug. A polarized plug has two blades with one wider than the other. A grounding type plug has two blades and a third grounding prong. The wide blade or the third prong are provided for your safety. When the provided plug does not fit into your outlet, consult an electrician for replacement of the obsolete outlet.
- **Protect** the power cord from being walked on or pinched particularly at plugs, convenience receptacles and the point where they exit from the apparatus.
- **Only** use attachments/accessories specified by the manufacturer.
- **Unplug** this apparatus during lightning storms or when unused for long periods of time.
- **Refer** all servicing to qualified service personnel. Servicing is required when the apparatus has been damaged in any way such as power-supply cord or plug is damaged, liquid has been spilled or objects have fallen into the apparatus, the apparatus has been exposed to rain or moisture, does not operate normally, or has been dropped.
- **Use** only with the cart, stand, tripod, bracket, or table specified by the manufacturer, or sold with the apparatus. When the cart is used, use caution when moving the cart/apparatus combination to avoid injury from tip-over.
- **No** naked flame sources, such as lighted candles or cigarettes etc., should be placed on the apparatus.
- **No user serviceable parts.** Refer all servicing to a qualified service engineer, through the appropriate Soundcraft dealer.



- It is recommended that all maintenance and service on the product should be carried out by Soundcraft or its authorised agents. Soundcraft cannot accept any liability whatsoever for any loss or damage caused by service, maintenance or repair by unauthorised personnel.



- **WARNING:** To reduce the risk of fire or electric shock, do not expose this apparatus to rain or moisture. Do not expose the apparatus to dripping or splashing and do not place objects filled with liquids, such as vases, on the apparatus. No naked flame sources, such as lighted candles, should be placed on the apparatus.
- Ventilation should not be impeded by covering the ventilation openings with items such as newspapers, table cloths, curtains etc.

WARNINGS



ADVICE FOR THOSE WHO PUSH THE BOUNDARIES

Although your new console will not output any sound until you feed it signals, it has the capability to produce sounds which, when monitored through an amplifier or headphones, can damage hearing over time.

Please take care when working with your audio — if you are manipulating controls which you don't understand (which we all do when we are learning), make sure your monitors are turned down. Remember that your ears are the most important tool of your trade, look after them, and they will look after you.

Most importantly — don't be afraid to experiment to find out how each parameter affects the sound — this will extend your creativity and help.



NOTE: This equipment has been tested and found to comply with the limits for a Class A digital device, pursuant to Part 15 of the FCC Rules. These limits are designed to provide reasonable protection against harmful interference when the equipment is operated in a commercial environment. This equipment generates, uses and can radiate radio frequency energy and, if not installed and used in accordance with the instruction manual, may cause harmful interference to radio communications. Operation of this equipment in a residential area is likely to cause harmful interference in which case the user will be required to correct the interference at his own expense.

This Class A digital apparatus meets the requirements of the Canadian Interference-Causing Equipment Regulations.

Cet appareil numérique de la Classe A respecte toutes les exigences du Règlement sur le matériel brouilleur du Canada.



NOTE: The packaging, in which your console arrived, forms part of the product and must be retained for future use.

WARRANTY

1 Soundcraft is a trading division of Harman International Industries Ltd.

End User means the person who first puts the equipment into regular operation.

Dealer means the person other than Soundcraft (if any) from whom the End User purchased the Equipment, provided such a person is authorised for this purpose by Soundcraft or its accredited Distributor.

Equipment means the equipment supplied with this manual.

2 If within the period of twelve months from the date of delivery of the Equipment to the End User it shall prove defective by reason only of faulty materials and/or workmanship to such an extent that the effectiveness and/or usability thereof is materially affected the Equipment or the defective component should be returned to the Dealer or to Soundcraft and subject to the following conditions the Dealer or Soundcraft will repair or replace the defective components. Any components replaced will become the property of Soundcraft.

3 Any Equipment or component returned will be at the risk of the End User whilst in transit (both to and from the Dealer or Soundcraft) and postage must be prepaid.

4 This warranty shall only be available if:

- a) The Equipment has been properly installed in accordance with instructions contained in Soundcraft's manual.
- b) The End User has notified Soundcraft or the Dealer within 14 days of the defect appearing; and
- c) No persons other than authorised representatives of Soundcraft or the Dealer have effected any replacement of parts maintenance adjustments or repairs to the Equipment; and
- d) The End User has used the Equipment only for such purposes as Soundcraft recommends, with only such operating supplies as meet Soundcraft's specifications and otherwise in all respects in accordance Soundcraft's recommendations.

5 Defects arising as a result of the following are not covered by this Warranty: faulty or negligent handling, chemical or electro-chemical or electrical influences, accidental damage, Acts of God, neglect, deficiency in electrical power, air-conditioning or humidity control.

6. The benefit of this Warranty may not be assigned by the End User.

7. End Users who are consumers should note their rights under this Warranty are in addition to and do not affect any other rights to which they may be entitled against the seller of the Equipment.

INTRODUCTION > SPECIFICATIONS

Si EXPRESSION TYPICAL SPECIFICATIONS

• **Frequency Response**

- Mic / Line In to any Output: +/-1.5dB, 20Hz-20kHz

• **T.H.D.**

- Mic Sensitivity -30dBu < 0.01% @ 1kHz

• **Noise**

- Residual noise -86dBu

- Mic Input E.I.N. 22Hz - 22kHz, Unweighted. (max gain) -126dBu (150Ω source)

- Mix noise, masters at unity < -86dBu

- 1 input to mix at unity gain -84dBu

- CMRR mic @1kHz (max gain) -80dBu

• **Crosstalk (@ 1kHz)**

- Channel ON attenuation <120dB

- Channel Fader attenuation <120dB

- Mic – Mic -100dB @ 1kHz, -85dB@10kHz

- Line – Line -100dB @ 1kHz, -85dB@10kHz

• **Input Gain**

- Mic Gain -5dB – 58dB integrated pad design, 1dB steps

- Line Trim -10dB - +16dB

• **Gate**

- Threshold -60dBfs - -6dBfs

- Depth -60dB – 3dB

- Attack 0.1ms – 200ms

- Release 20ms – 500ms

- Side-chain HPF 22Hz – 2.5kHz

- Side-chain LPF 160Hz – 20kHz

• **Compressor**

- Threshold -52dBfs - -6dBfs

- Ratio 1:1 – 20:1

- Attack 0.1ms – 200ms

- Release 5ms – 900ms

- Makeup Gain 0dB – 24dB

• **EQ**

- HI MID & LO MID 22Hz – 20kHz, +/-15dB Q 6-0.3

- Shelf (HF) 800Hz – 20kHz, +/-15dB

- Shelf (LF) 20Hz – 500Hz, +/-15dB

- HPF 40Hz – 1kHz

• **Delay**

- User adjustable delay 1sample – 500ms

- GEQ 31Hz – 16kHz 1/3 octave

• **Digital I/O**

- AES Sample rate converter range 8kHz – 200kHz

- External Word Clock In range 48kHz +/-7Hz (internal systems), +/-3Hz with stageboxes.

- Word clock out jitter +/- 7ns

- Analogue out for 0dBfs +21.5dBu

- Converter resolution 24-bit

- DSP resolution 40-bit floating point

• **Latency**

- Mic In to Line Out <0.8 ms

- Analogue in to AES out <0.6 ms

- AES in to Line Out <0.8ms

- AES in to AES out <0.5ms

- Stagebox Mic In to Stagebox <0.9ms

• **Input & Output Levels**

- Mic Input +22dBu max

- Line Input +22dBu max

- Mix Output +21.5dBu max

- Headphones (@150Ω) 300mW (recommended impedance 75Ω to 200Ω)

• **Input & Output Impedances**

- Mic Input 3kΩ

- Line Input 10kΩ

- AES Input 110Ω

- Outputs 150Ω (balanced), 75Ω (unbalanced)

- Word Clock used as Output 50Ω

- Word Clock used as Input 4k7Ω

- AES Output 110Ω

• **USB**

- Max current 200mA

• **Lamp Output**

- 12v DC 100mA max (per socket)

• **Power**

- Consumption (typical) <130w Si EXPRESSION 3

- AC Input voltage range 88-264VAC auto sensing

- AC Frequency range 47-63Hz

• **Operating Conditions**

- Operating Temperature Range 5°C to 45°C

- Humidity 0%-90%, non condensing Ta=40°C (104°F)

- Storage Temperature Range -20°C to 60°C (-4°F to 140°F)

E & OE.

Soundcraft reserves the right to change specifications without notice.

GETTING STARTED - AN INTRODUCTION TO THIS MANUAL

Anyone with minimal audio experience should be able to operate the Si Expression console without reading too much of this manual, though we do recommend you take the time to go through it. An excellent place to start would be the feature list on the introductory page (chapter reference 1.0), which will familiarise you with all of the main possibilities, facilities, and functions.

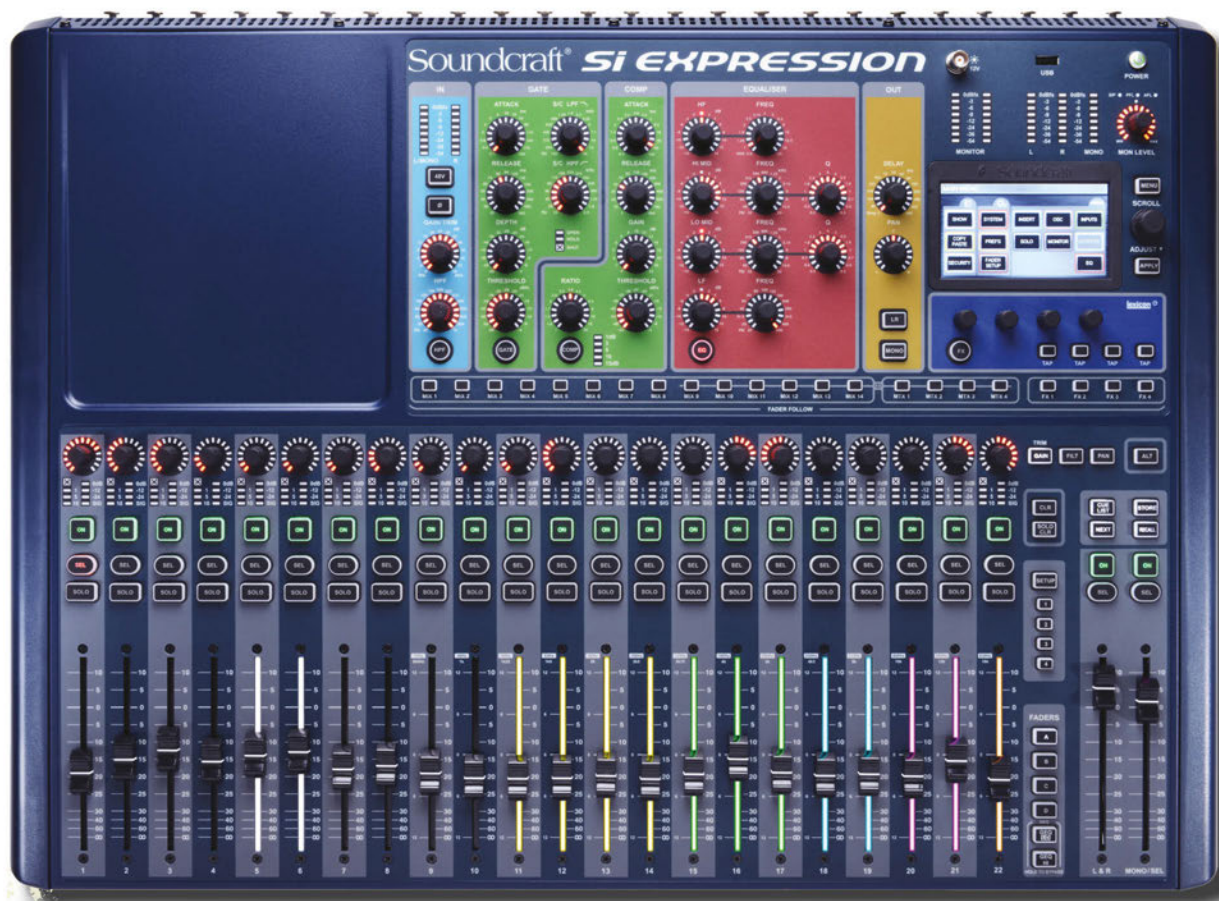

Please note: Most of the illustrations in this manual are based on the Si Expression 2 model. Where there are fundamental differences between operation of Si Expression 1, 2, and 3, it is noted in the relevant section.

PDF

If you're reading the PDF version of the manual, you can use the thumbnail view and links from the Contents page to navigate quickly.

GETTING STARTED > OVERVIEW

Si Expression consoles offer an incredible amount of flexibility and ease-of-use for their relatively compact size. To achieve this, there are several assignable features it is advisable you understand before using the console for performance.

Assignability

The Assignable Channel Strip (ACS) and Global Mode Encoders are relatively straight forward and work in conjunction with the Select (SEL) Control Channel buttons and the Encoder Mode buttons.

Essentially, assignability means that one button can *assign* a function to many other buttons. For example, pressing a Control Channel SEL button *assigns* that channel's entire channel strip and associated controls to the Assignable Channel Strip (ACS) section. In this way, the ACS can take the place of many sets of repeated controls.

In addition, the console has 14 Mix busses, four stereo Matrix busses, and four internal FX send busses, most conveniently accessed with the tOTEM (FADER FOLLOW) controls, which assign bus control to the console faders.

For full detail on the Si Expression's assignable controls, please see section 3.

Also note that the MIX 1-14 Busses and Bus masters serve the same function as Auxiliary Mix busses and masters.

Physical I/O, DSP Channels, Control Channels

Because the console has inputs and outputs that can be patched anywhere, and DSP channels that can be controlled by any Control Channel, these elements are considered separate in this manual.

Section 5 deals with the console's patching system, which connects physical inputs and outputs to DSP channels. **Section 6** deals with DSP channels (Input Channels, Mix busses and masters, and so on), routing, and channel-type-specific settings. **Section 7** deals with the assignable control channels (console surface controls) and the channel processing elements that they control.

Section 8 (Mix Features) deals with console performance functions that sit outside the assignable channel structure, such as Mute Groups, Copy And Paste, the interrogation function, the Solo system, and so on.

Touch Screen

The console Touch Screen has a simple, one-layer menu structure. The main menu is the default screen and can always be accessed by pressing the MENU button next to it. The Main Menu options are clearly labelled and lead to simple menus or special functionality, such as a QWERTY keyboard for text input etc. Please see Chapter 4 for more detail on the Main Menu options. The individual Menus themselves are dealt with in the relevant chapter references (For example, the INPUTS menu is dealt with in the Input Channels reference).

Power

The Si Expression incorporates a safety feature to prevent accidental shut-down. To shut down the console press and hold the POWER key for at least two seconds (it will flash orange) then press it again to confirm the power-down action. If you don't press power key the second time, it will revert to a steady green state and you will have to go through the process again to shut down.



GETTING STARTED > PARTS OF THE CONSOLE

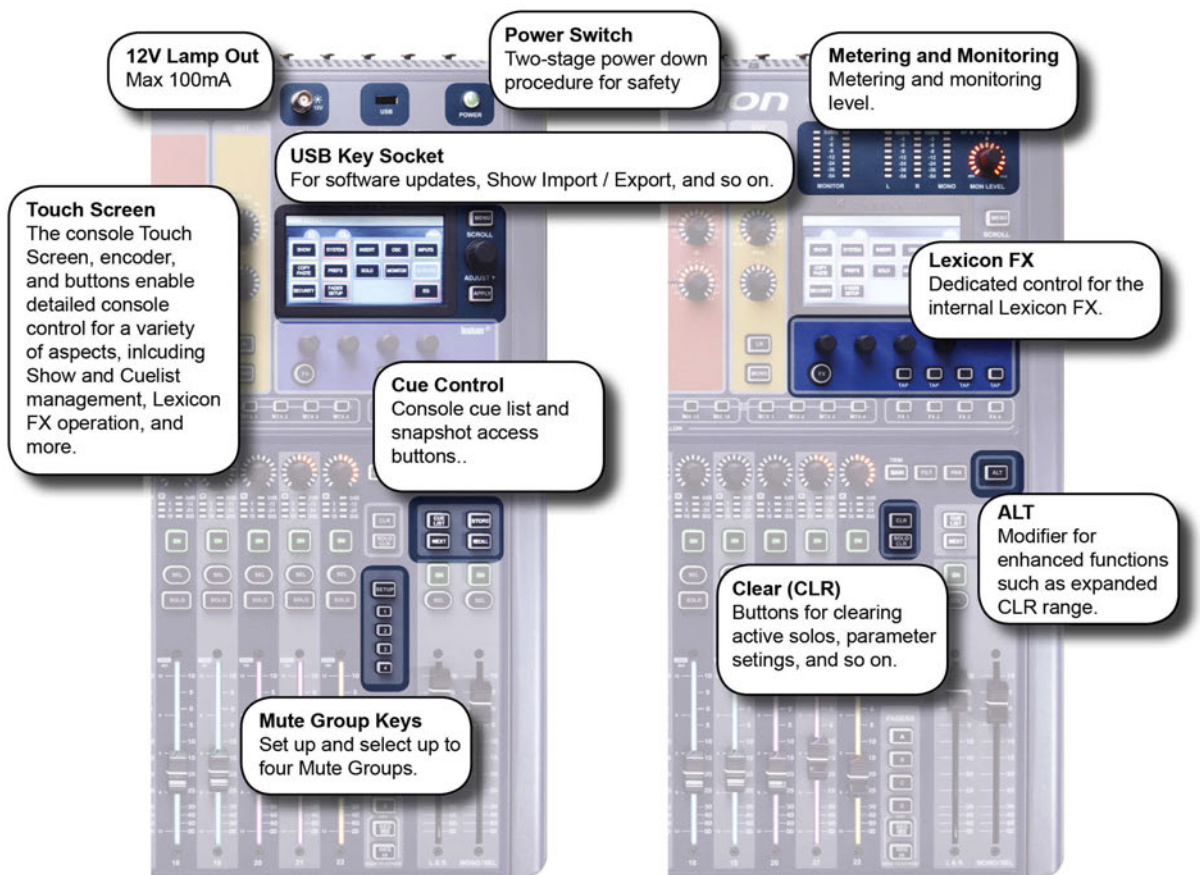
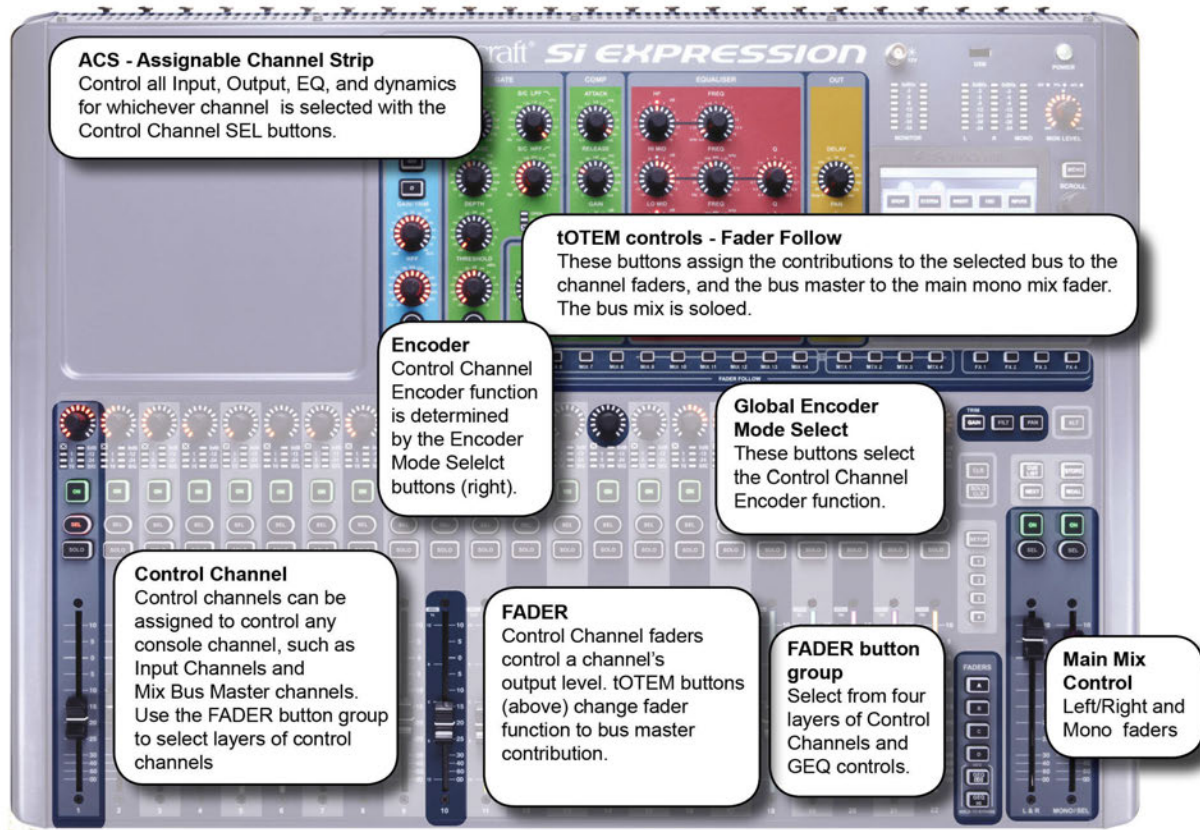

INTRODUCTION > PARTS OF THE CONSOLE

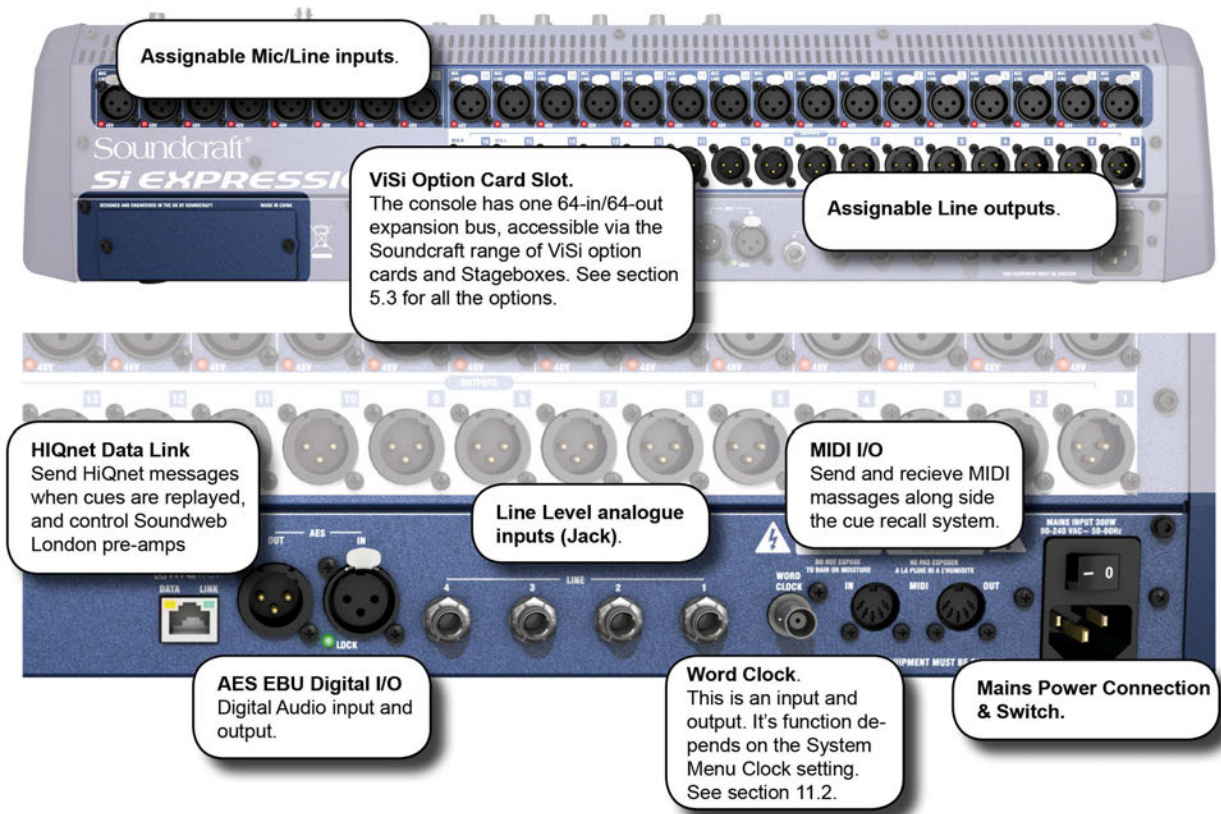

GETTING STARTED > FADERGLOW

Soundcraft FaderGlow™ (Pat. Pend.) is a unique feature that gives the user an additional level of status indication, and can significantly reduce operating errors.

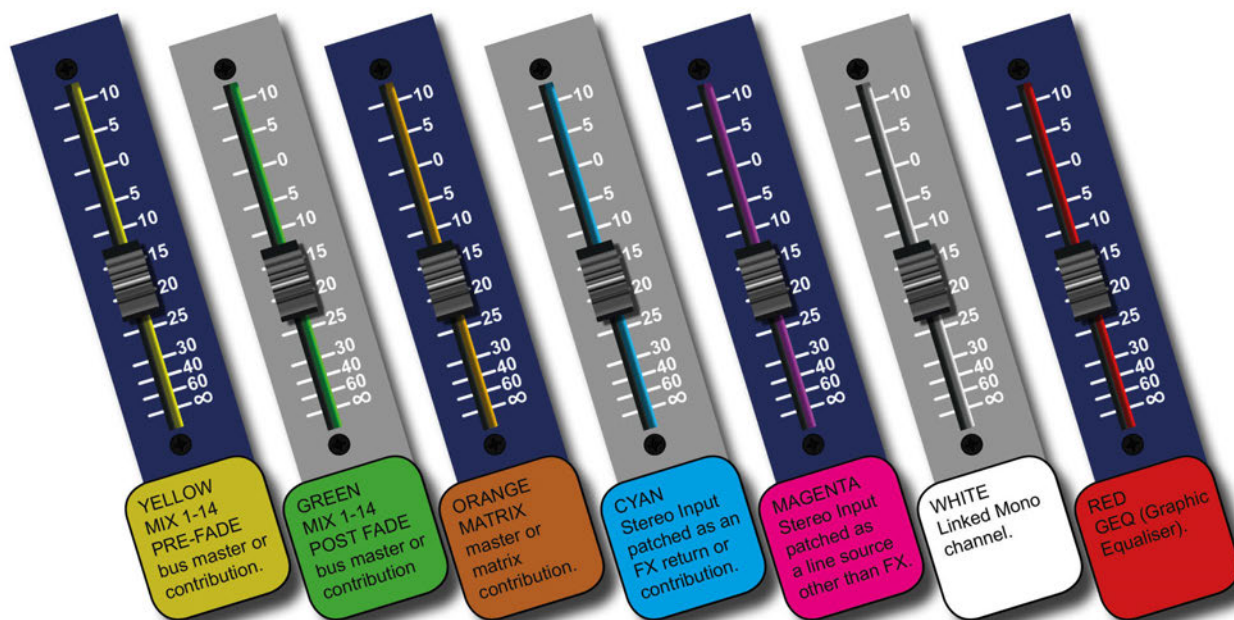

Several different functions can be assigned to the console faders, so it can be easy to lose track of which function is currently being controlled, especially when grabbing a fader in a hurry. The main principle of FaderGlow is to indicate the current fader function with colour, so more immediate recognition is possible. Soundcraft FaderGlow is fitted to all console faders that can change their function.

The Si Expression FaderGlow colours are:**YELLOW**

MIX 1-14 PRE-FADE bus master or contribution.

GREEN

MIX 1-14 POST FADE bus master or contribution

ORANGE

MATRIX master or matrix contribution.

CYAN

Stereo Input patched as an FX return or contribution.

MAGENTA

Stereo Input patched as a line source other than FX.

WHITE

Linked Mono channel.

RED

GEQ (Graphic Equaliser).

ASSIGNABLE CONTROLS

At the heart of the Expression is a group of assignable controls that make the console easier and faster to navigate and operate. Assignable controls work by changing the function of sections of the console surface. In this way, a single control can do several jobs, depending on the mode the console is working in. It is important that you understand the assignable controls on the Expression console in order to use it effectively - especially the way in which the FADERS and FADER FOLLOW buttons together determine the functionality of the Control Channels and Faders.

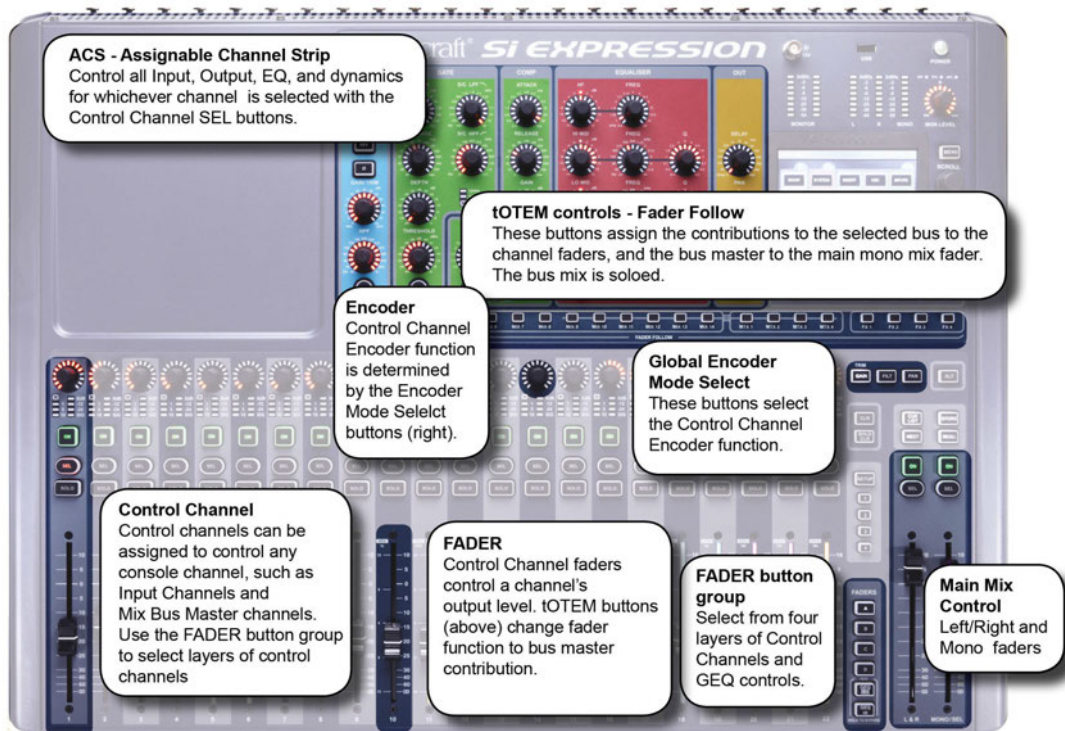

The main assignable controls on the Expression console are:

Control Channels

These are the vertical strips containing a Fader, Encoder, Status/Meter screen, plus the SOLO, SEL, and ON switches. They are assigned to control real input and output channels as well as GEQ bands and DMX channels or Masters. A group of Control Channels makes a Fader Layer.

Fader Layers (the FADERS button group)

Switch between whole layers of Control Channels. There are four DSP Control Channel Fader Layers, four DMX Fader layers, and two GEQ Fader Layers.

Assignable Channel Strip (ACS)

Used to control nearly all parameters on the active channel. Press a Control Channel SEL button to 'focus' the ACS.

Global Mode Encoders

Control Channel Encoders (top of Control Channels) change function depending on the Global Encoder Mode.

tOTEM (FADER FOLLOW button group)

The One Touch Easy Mix system used to assign Mix, Matrix, and FX Send busses to the Control Channel Faders.

3.1 FADER LAYERS

ASSIGNABLE CONTROLS > FADER LAYERS

The are four main Fader Layers on the Expression console, selected by the FADERS button (A, B, C, and D) group to the right of the Control Channels. The additional buttons in this group assign Graphic EQ bands across the faders for convenient control.

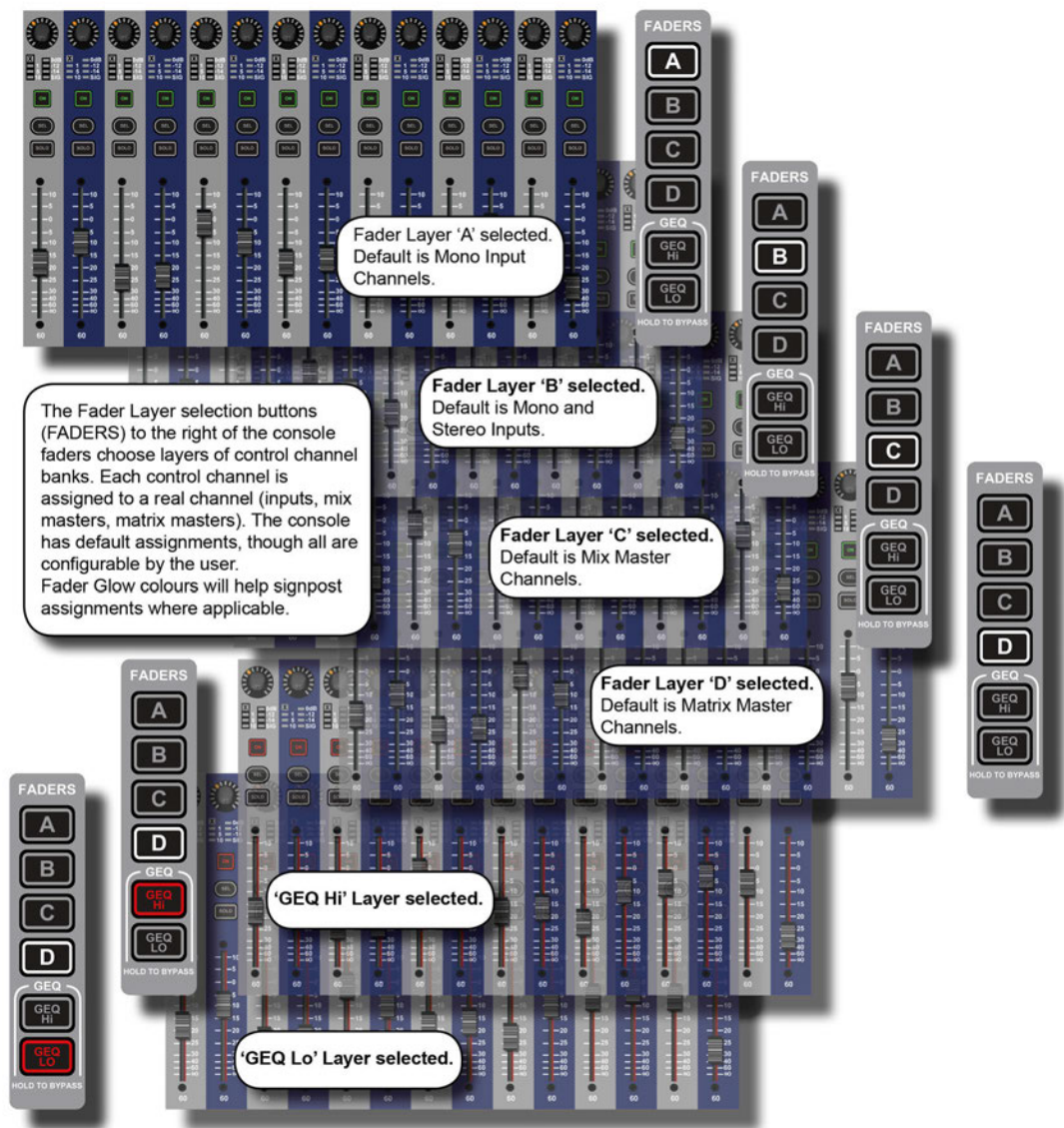

Each layer is made up of a number of Control Channel assignments. The Expression 1 has 14 Control Channels, the Expression 2 has 22, and the Expression 3 has 30 - plus the Left/Right and Mono main mix Control Channels.

By default, Layers A and B are assigned to input channels, with the Stereo input channels on the right hand end of layer B; Layer C is assigned to Mix Master channels; and the first four Control Channels of Layer D are assigned to the Matrix Master channels.

These assignments are user configurable in the FADER SETUP Touch Screen menu (see the Control Channels section of this reference chapter)

ASSIGNABLE CONTROLS > CONTROL CHANNELS

A Control Channel is an assignable Channel Strip for DSP Channels, with Encoder, Fader, indicators, plus ON, SOLO, and SEL buttons. The SEL button is used to focus the Assignable Channel Strip (ACS) on that channel. The DSP channel controlled by a Control Channel is determined by the current Fader Layer (FADERS button group) and assignment (FADER SETUP Touch Screen menu).

For more information on the individual controls, see section 7.3. Control Channel assignment is dealt with in 3.2.1.

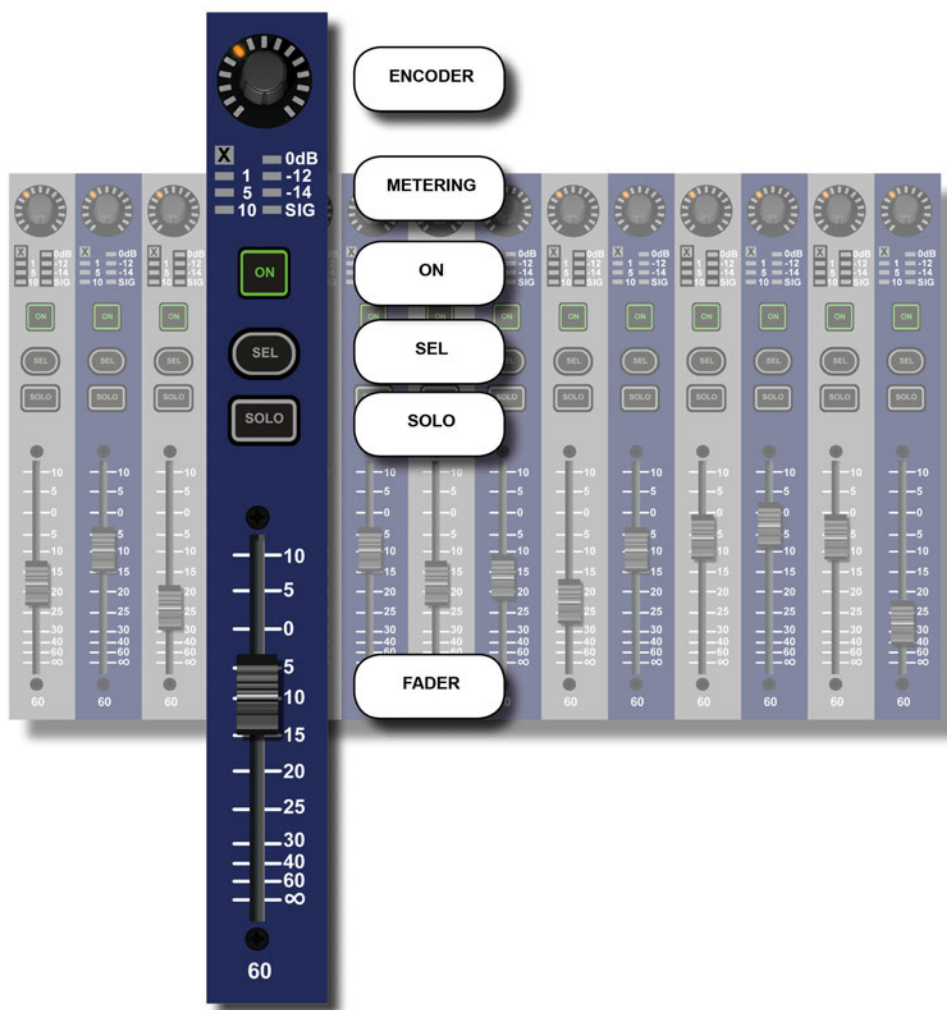

CONTROL CHANNELS > ASSIGNMENT

Control Channel Assignment is accessed via the FADER SETUP button in the Touch Screen Main Menu. Select the Control channel using the Fader Layer and SEL buttons in the usual way - the current Fader Bank and Slot Number cannot be edited in the FADER SETUP menu.

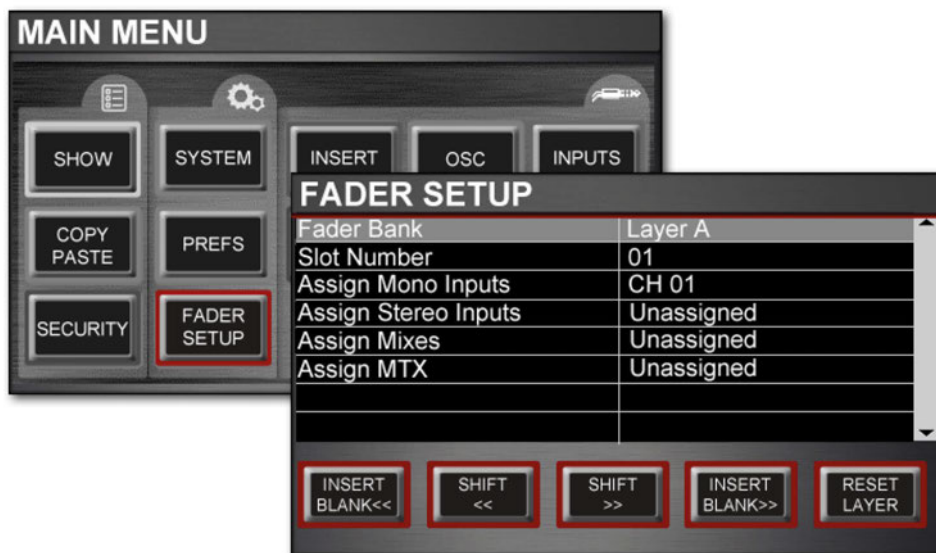

A DSP channel can be assigned to more than one Control channel, however, the Assignments are exclusive - you cannot assign more than one DSP channel to a selected Control Channel.



Fader Bank

Shows the currently selected Fader Layer.

This parameter cannot be edited in the menu - use the FADER button group to switch Fader Layers.



Slot Number

Shows the currently selected Slot Number (Control Channel Number) in current Fader Layer.

This parameter cannot be edited in the menu - use the Control Channel SEL buttons to choose a Slot/Control Channel Number.



Assign Mono Inputs

Assign a Mono Input channel to the currently selected Control Channel.

Touching the value field will bring up a scrollable list of available Mono Input Channel names.

CONTROL CHANNELS > ASSIGNMENT



Assign Stereo Inputs

Assign a Stereo Input channel to the currently selected Control Channel.

Touching the value field will bring up a scrollable list of available Stereo Input Channel names.



Assign Mixes

Assign a MIX Master channel to the currently selected Control Channel.

Touching the value field will bring up a scrollable list of available MIX Master Channel names.



Assign MTX

Assign a Matrix Master Channel to the currently selected Control Channel.

Touching the value field will bring up a scrollable list of available Matrix Master Channel names.



RESET LAYER

Reset the currently selected Fader Layer to its default Control Channel Assignments.

You will be asked to confirm this action as it will destroy any custom assignments on the current Fader Layer.



INSERT BLANK

Insert a blank Control Channel into the currently selected Control Channel Slot and shift the others to the left or right.

Choosing INSERT BLANK >> (right), for example, will push all Control Channels to the right of the currently selected slot, one slot to the right. The rightmost control channel will be lost. You will be asked to confirm this action.



SHIFT

Shift the currently selected channel allocation to the left or the right, as long as there is an unassigned slot available.

SHIFT>> and/or SHIFT<< will only be available when an adjacent unassigned Control Channel slot is available in the direction of the Shift.



ASSIGNABLE CONTROLS > GLOBAL ENCODER MODE

Global Mode - Control Channel Encoders

The encoders at the tops of the control channels can be switched globally between three different functions - GAIN/TRIM, FILTER (HPF adjust), and PAN - simply by pressing the corresponding Global Encoder Mode button. The Global Encoder Mode button group is situated on the right-hand end of the console, above the LR and M Main Mix Control Channels.

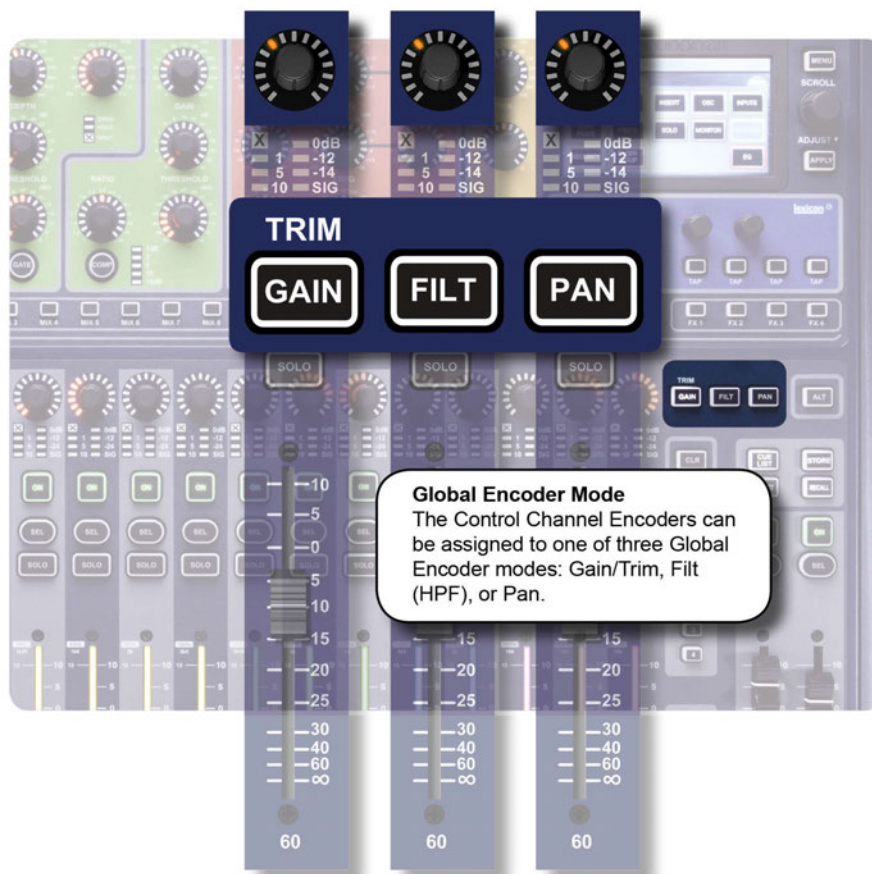

ASSIGNABLE CONTROLS > ACS

By pressing the SEL (Select) button on any available channel, you assign that channel's controls to the ACS. From the ACS you can control all input, EQ, dynamics, and output functions available to the selected channel. Adjusting an ACS control will trigger the 'Function Focus' feature and the console Touch Screen will reflect any changes you make in greater detail, as you make them.

For more information on the ACS controls and processing elements, see section 7.2.

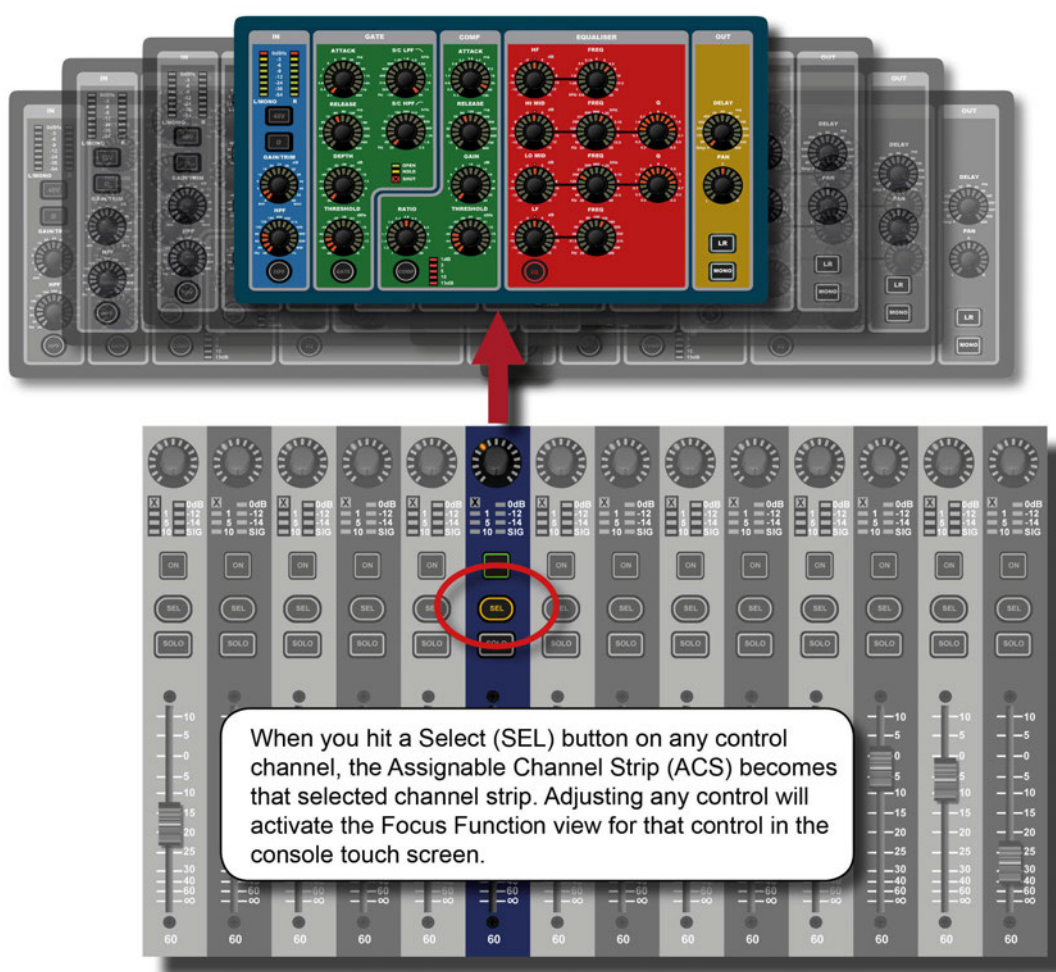

When you hit a Select (SEL) button on any control channel, the Assignable Channel Strip (ACS) becomes that selected channel strip. Adjusting any control will activate the Focus Function view for that control in the console touch screen.

ASSIGNABLE CONTROLS > tOTEM (FADER FOLLOW)

tOTEM (The One Touch Easy Mix) buttons MIX 1-14, MTX 1-4, FX 1-4, situated just below the ACS, make up the FADER FOLLOW button group and allow rapid access to bus contributions from channels in any current Fader Layer.

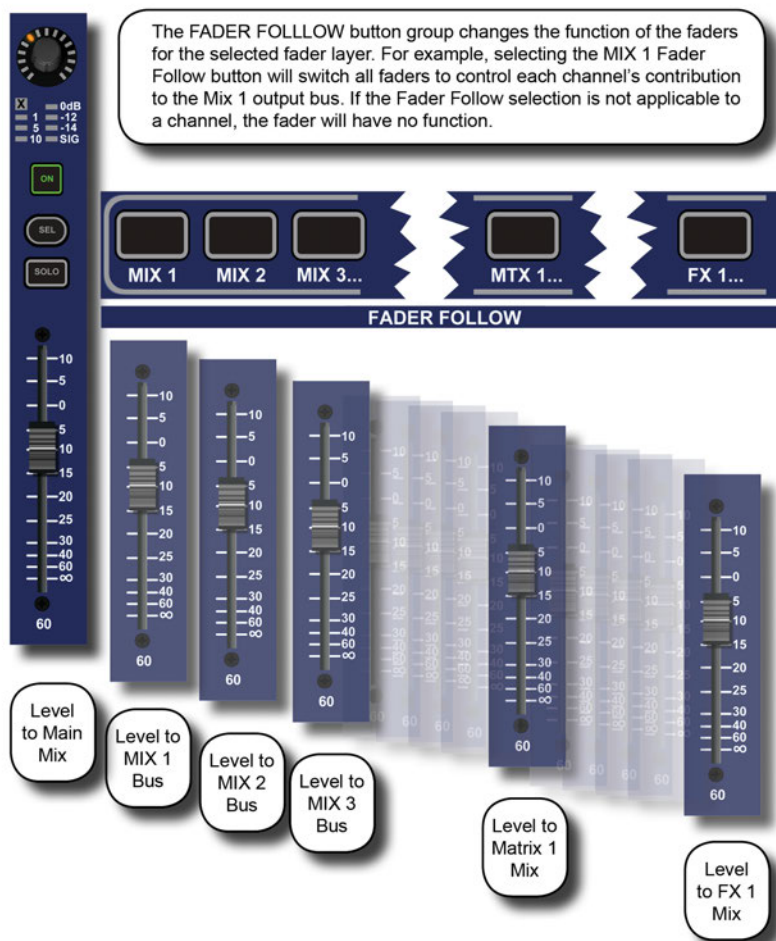

If your current fader layer is the default 'A' layer (all input channels), then pressing the MIX 1 Fader Follow button will assign all channel faders to control the Mix 1 sends for those channels and the Mono control channel fader to control of the bus master. This allows one-touch access to complete bus mixes.

In addition, when a tOTEM button is pressed all existing solos will be cleared, the selected bus will be soloed, and the ACS will be assigned to the selected bus master channel.

If a tOTEM Fader Follow button is selected that is not applicable to a channel type, then the fader will have no function (selecting a Matrix (MTX) bus contribution for an input channel, for example).

TOUCH SCREEN

The console colour Touch Screen can be used through direct touch, or in conjunction with the Scroll Encoder and the MENU / APPLY buttons. It provides access to System settings and preferences, Copy/Paste and cue list / Show functionality, as well as settings for inputs, outputs monitoring, the solo system, plus a frequency response-type display of the 4-band EQ.

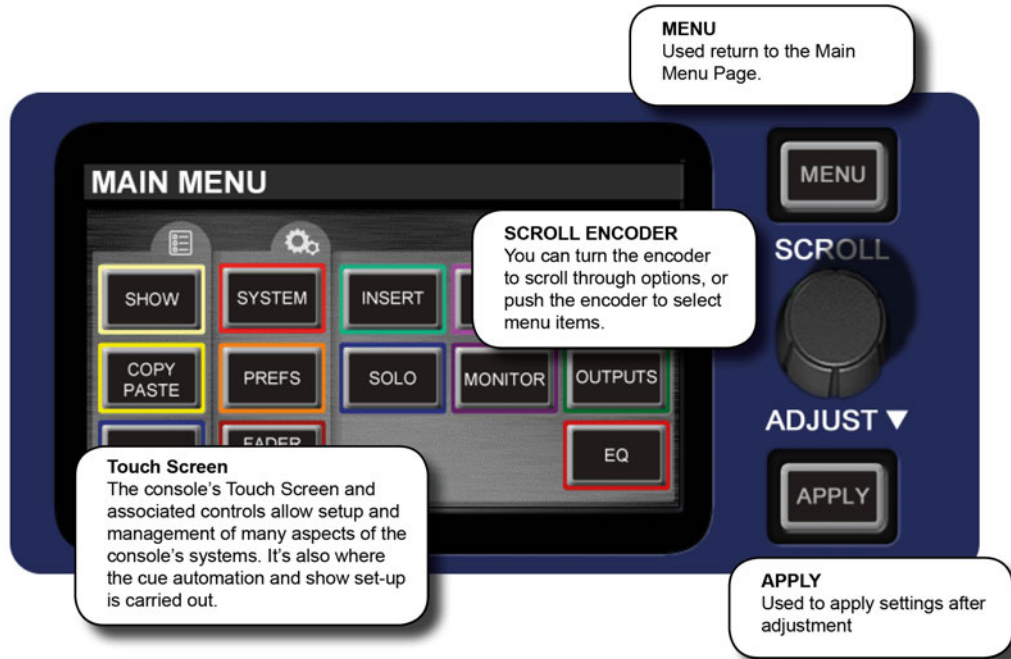

MENU

Access the Touch Screen Main Menu.

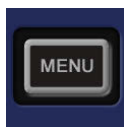

Encoder

Scroll or adjust parameters, and select value fields.

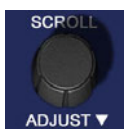

Turn the Encoder to navigate a menu; press the Encoder to select a value field for adjustment, then turn the encoder again to adjust the value field.



APPLY

Apply the set value, where applicable.



The Apply button will illuminate white when required to confirm values.

TOUCH SCREEN > MAIN MENU

The Touch Screen Main Menu can be accessed at any time by pressing the MENU button next to the Touch Screen. From here you can navigate to any of the settings menus.

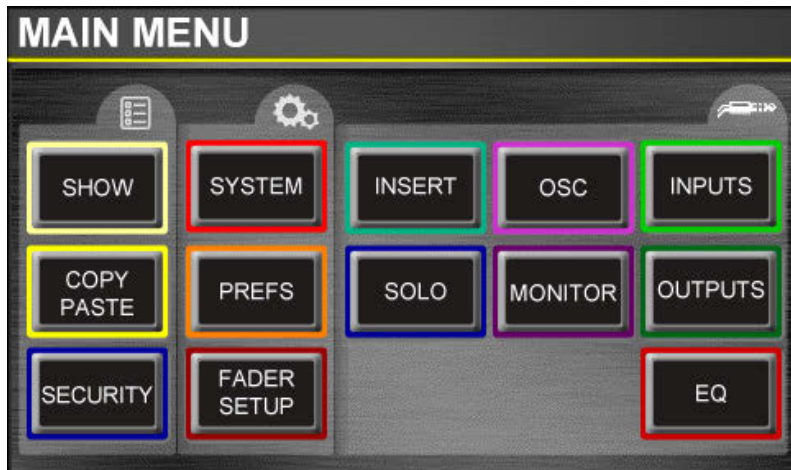

SHOW

Show File operations and global Isolate settings, plus the RESET CONFIG function.

New show, load, reset functions for show files. Isolate settings are used to isolate parameters from show recalls. See section 9.1 - Show Storage and recall - for more detail. The RESET CONFIG function forces the console to re-discover and reset the I/O configuration.



COPY PASTE

Used to copy and paste settings between channels.

Press copy to copy to clipboard, then press and hold PASTE-HOLD and use the SEL buttons to Paste. See Reference 8.2 for more detail.



SECURITY

Console Admin settings and selective 'lock-out'.

See section 11.3 for more detail.



TOUCH SCREEN > MAIN MENU



SYSTEM

System information, HiQnet and IP addressing, selective console reset functions, and the Event Log.

Use the system menu to reset channels, busses, patching, and the whole console. See section 11.2 for more detail.



PREFS

Brightness settings and D.O.G.S. system (Direct Out Gain Stabiliser) On/Off.

When enabled, D.O.G.S. Adjusts the direct output level from each channel inversely to any manual change of a mic gain control. See section 11.1 for more detail.



FADER SETUP

Assign DSP channels to Control Channel slots.

Use FADER SETUP to create custom Fader Layers. See section 3.2.1 for more detail.



INSERT

Setup and patching of the four available insert sends and returns.

See section 5 - Inputs & Outputs - For more information. Remember, an insert interrupts signal flow, so if an insert is assigned to a channel, the signal must have a return path.



SOLO

Solo system settings.

Options include Highlight, Blend, and Solo Trim levels, as well as Solo In Place and Input Priority On/Off. See section 8.4 for more information.



TOUCH SCREEN > MAIN MENU



OSC

Settings and operations for the built in Oscillator.

Routing, waveform, frequency, and output options. See section 13 for more detail.

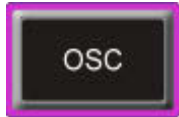

MONITOR

Settings for the monitoring systems.

Delay, patching, and Mono Check. See section 8.5 for more information.



INPUTS

Input channel-specific settings.

Active when an Input channel is selected. For The menu will show Naming, patching, Channel Isolate, Mix contribution routing, and so on. See section 6.1.1 for more information.

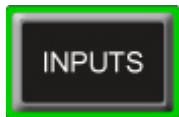

OUTPUTS

Output channel-specific settings.

Active when an Output channel (Mix Bus Master, Matrix Master, LR or M/C Main) is selected. The menu will show Naming, patching, bus routing, and so on. See section 6.2.1 for more detail.



EQ

Graphic representation of the EQ for the selected channel.

Simply touch the EQ Touch Screen button to see the frequency response graphic - incorporates the HPF and 4-band EQ, but not the Graphic EQ. See section 7.2.4 more more on the ACS EQ section.



INPUTS AND OUTPUTS

The console has an assignable patching system for all inputs and outputs. In other words, any internal audio signal input or output can be assigned a physical input or output. At its simplest, this might mean that the input to Channel 1 is patched to MIC01 (the first local mic/line XLR socket).

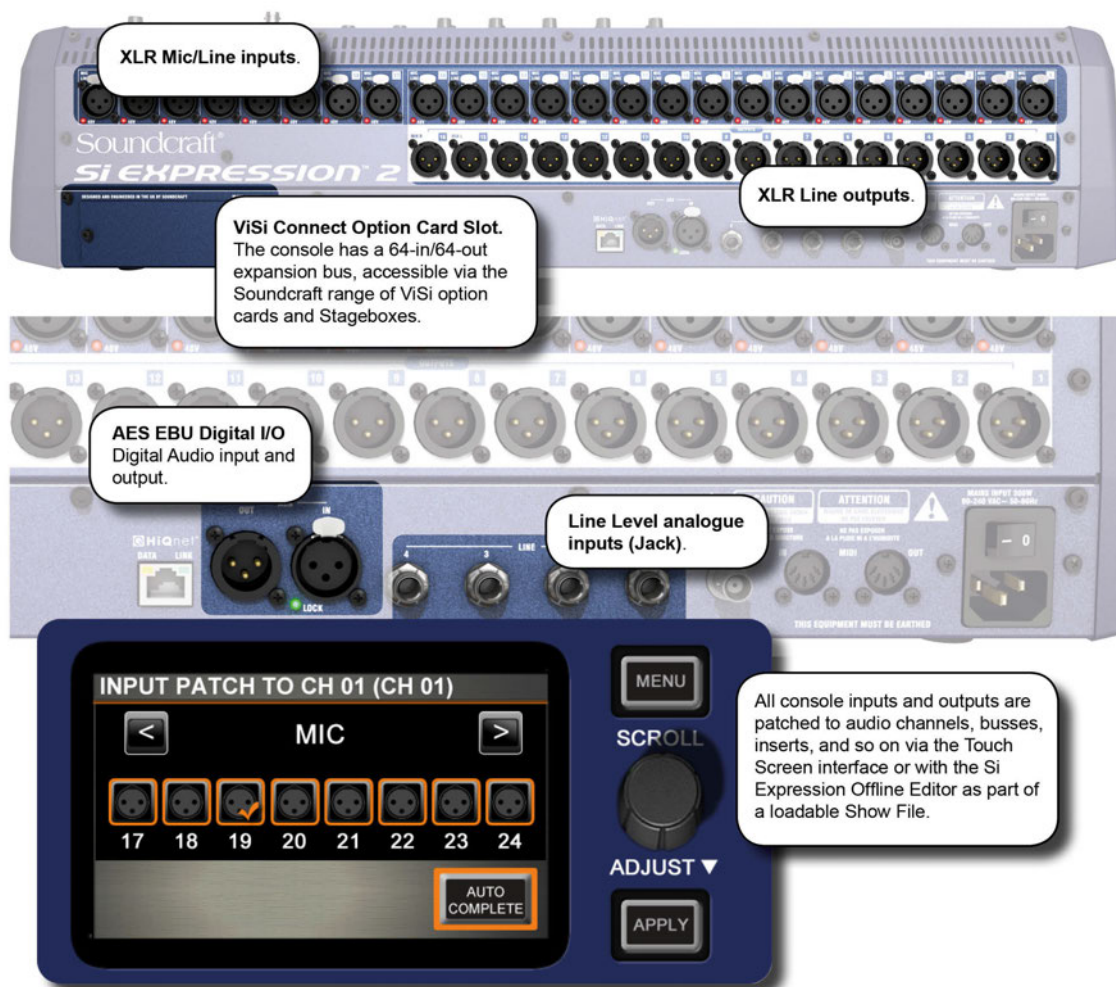

All console inputs and outputs are patched to audio channels, busses, inserts, and so on via the Touch Screen interface or with the Si Expression Offline Editor as part of a loadable Show File.

The console does have a factory default patching configuration, which is used whenever the console is reset to its default (SYSTEM menu > RESET PATCHING or RESET ALL).

Additionally, the console has a ViSi compatible option card slot with 64-in / 64-out expansion capability that can be used with a wide range of I/O cards, or a Soundcraft Stagebox (when a MADI card is installed).

INPUTS AND OUTPUTS > PATCHING

When patching an input or output, you will be presented with an I/O selection screen. The current patch is shown with an orange tick over the relevant patch icon.



Scroll left or right through the available options and select from the labelled patch icons. The system will only show option cards if they are fitted, or if the show was *created* on a console with expansion cards fitted, or if the show was created with option cards in the offline editor.

The internal Stereo FX returns are shown as available inputs - these are assigned by default to Stereo Input channels 3-6.

You can use console SEL buttons to choose other channels while the patching screen is open.

Stereo Channels

When stereo channels are patched, the system will allow you to choose consecutive odd/even pairs. In any patching menus, the odd-numbered channel will be listed as the current patch. For example, if the Stereo Input channel ST 01 shows LINE IN1 in the Input Patch menu item, then the left channel will be patched to LINE IN1 and the right channel will be patched to LINE IN2. In the patching screen, both LINE IN 1 and LINE IN2 patch icons will be shown with ticks.

NOTE: Stereo channels can only be line level or digital inputs, or FX returns - not microphone inputs.

Auto Complete

To have the system automatically patch multiple channels press the AUTO COMPLETE button; this will increment the input by 1 and patch by 1 until a logical 'group' of patches is complete.

The logical 'group' idea exists to prevent AUTO COMPLETE overwriting too many channels and mix buses, or physical inputs and outputs. The auto complete boundaries are nominally grouped in eights (e.g. mic inputs 1-8, mic inputs 9-16, input channels 17-24, input channels 25-32).

However, Auto Complete groups may be smaller if there are fewer than eight channels available in that type. For example, if you start Mix Bus 9 patched to Line Out 9 then press AUTO COMPLETE, the process will stop at Mix Bus 14 to Line Out 14. However if you started with Mix Bus 1 to Line Out 9 then press AUTO COMPLETE, the process will stop at Mix Bus 8 to Line Out 16.

INPUTS AND OUTPUTS > PATCHING

Patching for the various inputs and outputs on the console can be accessed as follows:

Input Patch

Source for an Input Channel. Input Channel selected > INPUTS menu.

Direct Output Patch

Direct output from an Input Channel. Input Channel selected > INPUTS menu
Also, see D.O.G.S. below.

Bus Master Output

Two available outputs from each Mix, Matrix, LR, or M Master Channel. Bus Master selected > OUTPUTS menu.

Oscillator Patch

Physical output for Oscillator signal. OSC menu.

Monitor Patch

Physical stereo output for Monitor line output. MONITOR menu.

Insert Patch

Inserts are set up in the INSERT menu. Use the INSERT ASSIGN menu to assign insert points to channels, and use the INSERT SETUP button on the same screen to assign insert sends and returns to physical outputs.

NOTE: Patch changes are stored per cue. Having made any patch changes the cue must be stored or updated to make the change permanent.

D.O.G.S. - Direct Output Gain Stabiliser System

D.O.G.S. is a tool to help maintain stored gain structure between channel input and direct output when multiple devices are sharing a single source. In other words, it prevents Direct Output levels from changing when a Mic Gain is changed - so any feeds taken from the console remain stable.

When enabled, D.O.G.S. adjusts the direct output level from each channel inversely to any manual change of a mic gain control (across a change of +16/-10dB) on that channel.

You can enable or disable D.O.G.S in the Preferences Menu via PREFS. See section 11.1.

INPUTS AND OUTPUTS > PATCHING > SOUNDWEB

With V1.6 software, Si Performer and Si Expression consoles can now control BSS Soundweb London devices' preamp controls via Harman's HiQnet protocol. When a digital audio transport card (i.e. Dante, BLU Link, Cobranet, etc.) is installed in a Si Performer/Expression and your Si console is connected to a network with Soundweb London devices via the HiQnet port on the back of the console, you can now bring up the SOUNDWEB LONDON EXTERNAL PREAMP control.

INPUT PATCH TO CH 01 (CH 01)

MADI
MADI IN/OUT CARD
Range [1-8] present in slot 1

17 18 19 20 21 22 23 24

SOUNDWEB EXTERNAL PREAMP CONTROL 01

External Control Status	Enabled
Node Address	0
Input Card	A
Input Channel	1

To Patch and control Soundweb London device preamps, they must be connect to the network via the HiQnet CAT5 connection (Network settings in SYSTEM Menu).

Press and hold a digital input patch icon for the Soundweb-specific settings.

Soundweb External Preamp Control device setup is saved in show files and Mic Gain and 48V values can be recalled with snapshots. Snapshot recall of these values can also be disabled with the ISOLATE feature

Network Settings

The first step to configuring Soundweb London devices is setting up the IP settings in the SYSTEM menu on your Si console. The Soundweb London device and the Si console must be on the same subnet in order to communicate. See chapter reference 11.2 for more detail.

Control Access

Press and hold a digital input patch icon to add Soundweb London external preamp control to that channel. This will bring up the Soundweb London Control Menu (see below).
input channels 17-24, input channels 25-32).

Note: Soundweb London preamps are controlled in 6dB increments. Trim control can be performed in 1dB increments.



External Control Status.

Disable / Enable Soundweb London Preamp control for this patch.

If enabled, this will activate MIC GAIN* and 48V control from the console on that input channel for the associated Soundweb London device. If Disabled, it will deactivate the MIC GAIN and 48V control from the console, but will keep all the settings (Node Address, Input Card, Input Channel) and the last set gain value.



Node Address

Set the Soundweb London devices' node address to send and receive HiQnet values to your Si console.

The node address can be found and adjusted in London Architect and Audio Architect software platforms. It is important to note that the Node Address value in the Si console must be given in decimal format rather than hexadecimal format.



Input Card

Select an input card on the Soundweb London device.

There are four fixed entries: A, B, C, D. Choosing A, for example, will allow you to control one of the input channels on the Soundweb London's A input card.



Input Channel

Select an input channel on the selected card and device.

INPUTS AND OUTPUTS > DEFAULT PATCHING

The default patching for Expression consoles - also shows default Fader Layers in brackets.
The console patching can be reset to default via the SYSTEM menu.

Inputs

Expression 1

- Mic In 1-14 > Input Channels 1-14 (Fader Layer A, slots 1-14).
- Mic In 15-16 > Input Channels 15-16 (Fader Layer B, slots 1-2).
- Unassigned inputs x 6 > Input Channels 17-22 (Fader Layer B, slots 3-8).
- Line Inputs 1-4 > Stereo Inputs 1-2 (Fader Layer B, slots 9-10).
- Stereo FX Returns 1-4 > Stereo Inputs 3-6 (Fader Layer B, slots 11-14)

Expression 2

- Mic In 1-22 > Channels 1-22 (Fader Layer A, slots 1-22).
- Mic In 23-24 > Channels 23-24 (Fader Layer B, slots 1-2).
- Unassigned inputs x 14 > Channels 25-38 (Fader Layer B, slots 3-16).
- Line Inputs 1-4 > Channels Stereo Input Channels 1-2 (Fader Layer B, slots 17-18).
- Stereo FX Returns 1-4 > Stereo Input Channels 3-6 (Fader Layer B, slots 19-22).

Expression 3

- Mic In 1-30 > Channels 1-30 (Fader Layer A slots 1-30)
- Mic In 31-32 > Channels 31-32 (Fader Layer B slots 1-2)
- Unassigned inputs x 22 > Channels 33-54 (Fader Layer B slots 3-24)
- Line Inputs 1-4 > Stereo Input Channels 1-2 (Fader Layer B slots 25-26).
- Stereo FX Returns 1-4 > Channels Stereo Input Channels 3-6 (Fader Layer B slots 27-30).

Outputs

- MIXES 1-14 > Analogue Line Out 1-14 (Fader Layer C slots 1-14)
- MTX 1-4 > Not Assigned (Fader Layer D slots 1-4).
- Main L&R > Analogue Line Out 15-16 (Master L&R Fader).
- MONO > Not Assigned (MONO/SEL Fader).

INPUTS AND OUTPUTS > ViSi CONNECT

The ViSi Connect card slot on the back of the console offers a 128 channel (64-in / 64-out) interface for the connection of additional inputs and outputs. There are a variety of available modules, including a MADI card that can be used to add a Soundcraft Stagebox for expanded I/O capabilities.



The ViSi Connect card I/O is patched in the same way as the normal system I/O - via the INPUTS, OUTPUTS, OSC, INSERT, and MONITOR menus, depending on what type of source or destination you are patching.

See the *Soundcraft Si Option Slot & Option Card User Guide* for detailed instructions on card installation and configuration.

INPUTS AND OUTPUTS > ViSi CONNECT > CARDS

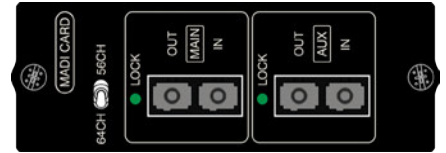

- Single Port CAT5 MADI
- Dual Port CAT5 MADI (redundant link)
- Dual Port Multi-Mode SC Optical MADI (redundant link)

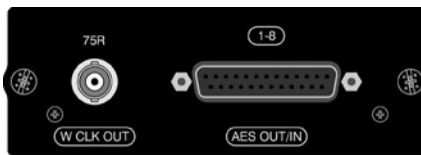

- AES 3 XLR (4ch in, 4ch out on XLRs)
- AES D-Type (8ch in, 8ch out, 25-way D-SUB connector)



Multi Digital Card (32 in / 32 out - FireWire for Mac, USB or FireWire for PC, plus 8 in / 8 out ADAT optical).



Dante (64 x 64 interface to Dante digital audio network)



Riedel RockNet

INPUTS AND OUTPUTS > ViSi CONNECT > CARDS

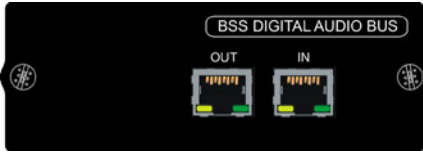

BLU Link (32 x 32 interface to Soundweb London digital audio bus)

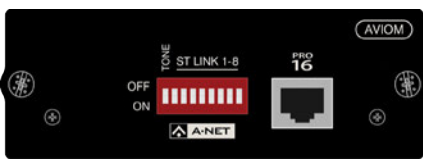

Aviom® A-Net (16 output channels, CAT5 - Pro-16 head)



CobraNet™ (Up to 32 in and 32 out)



MADI-USB (32 in/out MADI + 32 in/out USB OR 64 in/out MADI only. Connect Soundcraft Stagebox plus a PC or Mac.

INPUTS AND OUTPUTS > ViSi CONNECT > STAGEBOXES

With a MADi card fitted, the Si Expression can be connected to A variety of additional I/O, including the Soundcraft Stageboxes.

**Soundcraft Mini Stagebox**

Two variations of a smaller Stagebox for general use when modular I/O is not required.

The Mini Stagebox 32 (3U) provides 32 analogue inputs and 8 analogue line outputs, with 4 pairs of AES outputs, providing a total I/O capacity of 32 inputs and 16 outputs, with the Mini Stagebox 16 (2U) model providing 16 analogue inputs and 8 line outputs making a 16 x 8 matrix. They connect to any of the Soundcraft Si Expression, Si Compact, Si Performer, Si Series and Vi Series consoles via a MADi card fitted to the option card slot.

**Soundcraft Compact Stagebox**

A high density of I/O connections in only 4U of rack space. The modular unit is fully configurable but is offered with a standard configuration of 32 mic/line inputs, 8 line outputs, 8 channels of AES/EBU outputs and 2 expansion slots for standard Studer D21m I/O cards. The D21m is the I/O architecture for Studer as well as Soundcraft digital mixing systems and allows connection to most popular digital formats, including CobraNet®, AVIOM A-Net®16, Ethersound, ADAT and RockNet. A MADi recording interface can also be fitted to the expansion slots.

CHANNELS & BUSSES

The Si Expression console has several basic channels and busses. These are mono and stereo input channels, mono and stereo Mix Busses and MIX output master channels (MIX 1-14), internal FX send mix busses (FX 1-4), stereo Matrix mix busses and Matrix output master channels (MTX 1-4), and the main Left, Right, and Mono/Centre mix master channels.

Input, Mix, and Matrix Routing

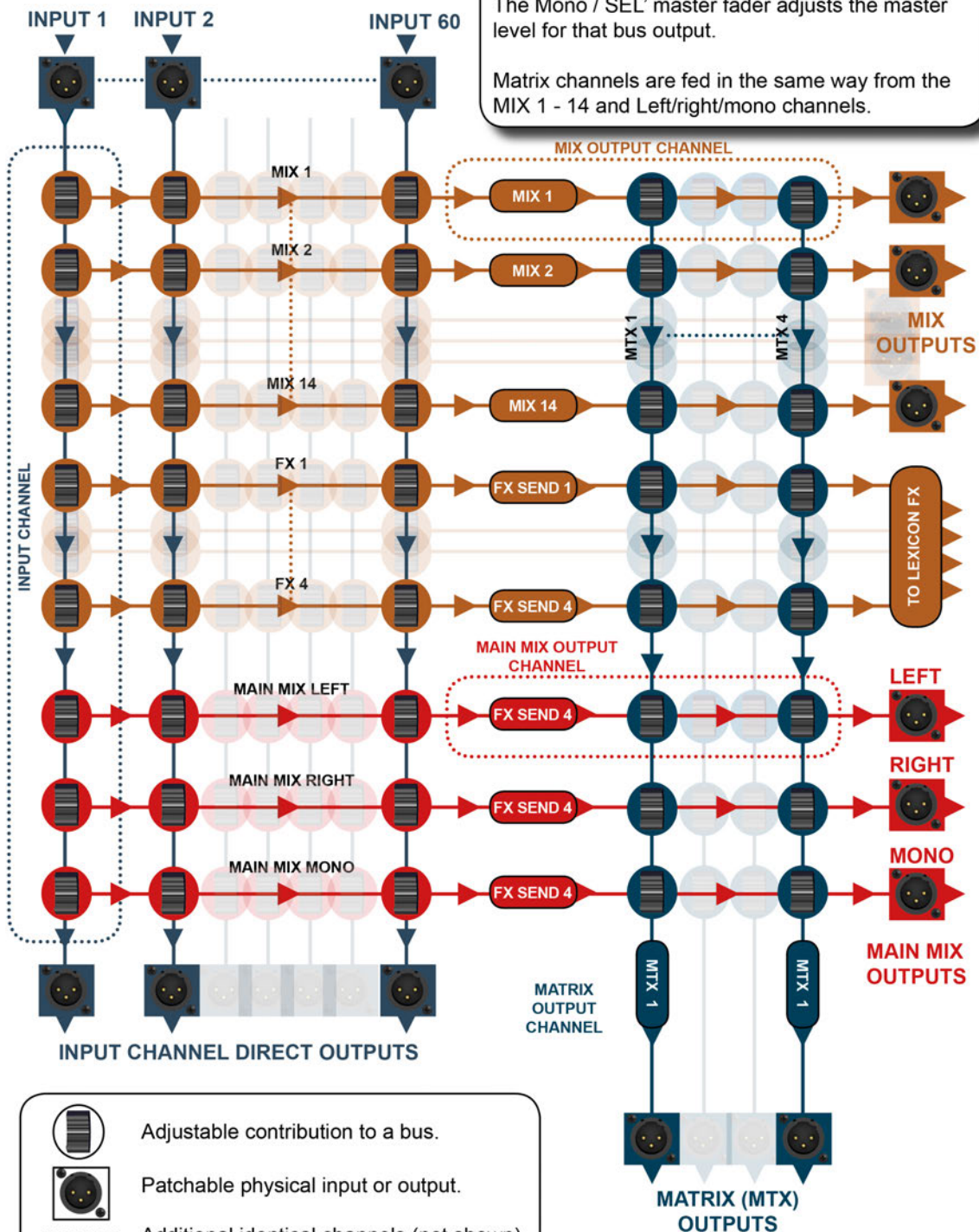

Mix Bus Master channels (MIX 1 - MIX 14) are fed from the input channels. When you select a MIX 1 - 14 bus button, every input channel's fader adjusts that channel's contribution to the selected bus. The Mono / SEL' master fader adjusts the master level for that bus output. Matrix channels are fed in the same way from the MIX 1 - 14 and Left/right/mono channels.

CHANNELS & BUSSES > INPUT CHANNELS

Input channels receive either external input from instruments, microphones, and so on, or they receive input from the internal Lexicon FX units - in which case they are an FX return.

Input channels can be mono (56 available: CH 01 - CH 56), stereo (6 available: ST 1 - ST 6), or mono-linked (assigned in odd/even pairs of mono Input Channels), and can be patched to any microphone, line, or digital input. Mono inputs do not have a FaderGlow colour. Mono-linked channels use FaderGlow white, stereo input channels (external line source) use FaderGlow pink, and stereo FX returns from the internal FX units use FaderGlow cyan and are patched to ST 3 - 6 by default.

Input channels can contribute to any or all of the MIX 1-14 Mix busses (which feed the Mix Bus Master channels), the Main L&R and Mono mix busses, or to the FX send busses - which get routed to the internal Lexicon FX. The levels of these contributions are accessed via the tOTEM (FADER FOLLOW) buttons.

Please note, Input Channels can not contribute to the Matrix (MTX) busses, so the MTX FADER FOLLOW buttons are not applicable for Control Channels assigned to Input Channels.

There are various input-specific options, found via the Touch Screen Main Menu INPUTS button. These offer channel naming, linking, Pre/Post routing options for Mix busses and direct outputs, and physical input and Direct Output patching. See section 6.1.1.

CHANNELS & BUSSES > INPUT CHANNELS

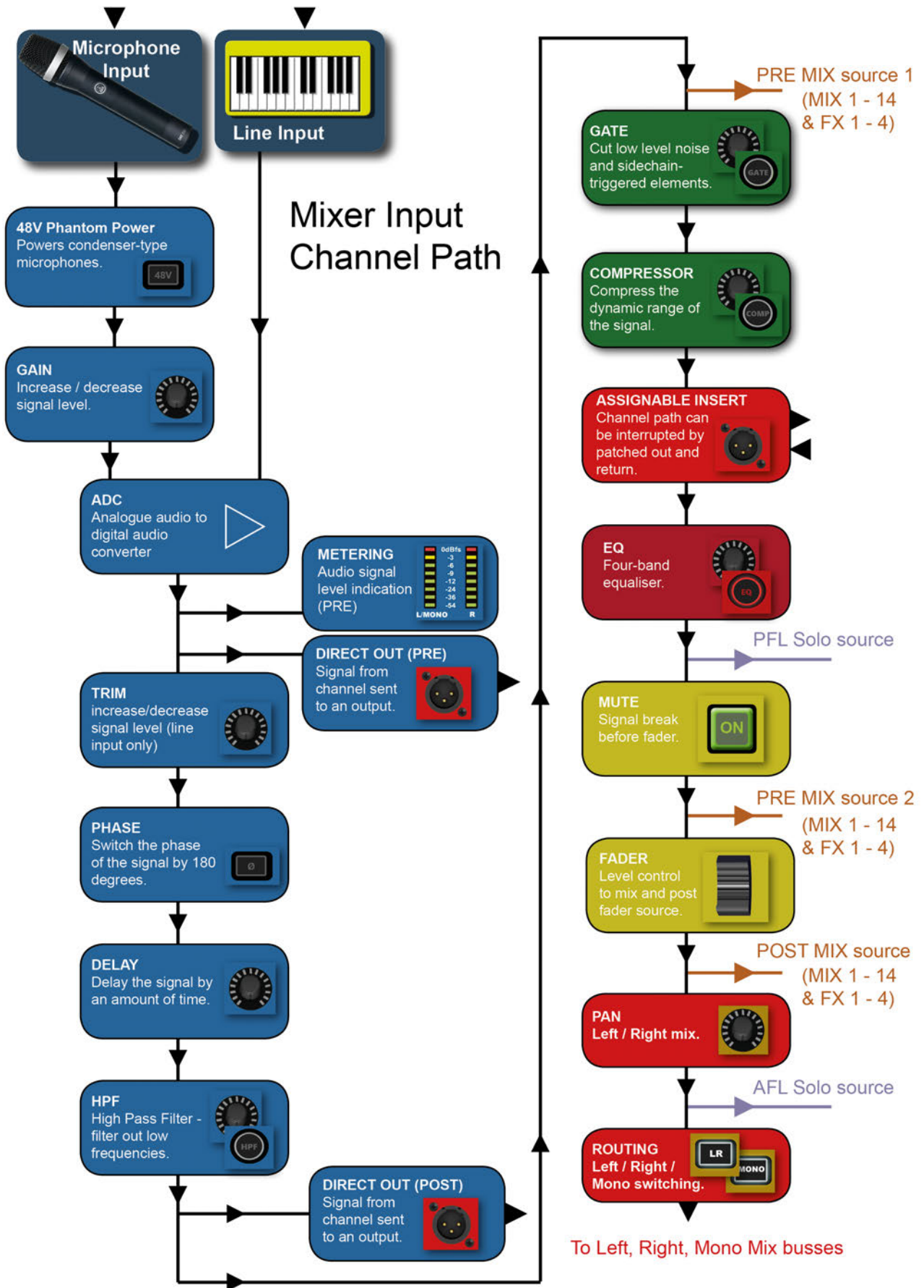

CHANNELS & BUSSES > INPUT CHANNELS > SETUP

There are various input-specific options, found via the Touch Screen Main Menu INPUTS button. These offer channel naming, linking, Pre/Post routing options for Mix Busses and Direct Outputs, and physical input and Direct Output patching.

CH 01 SETUP	
General	
- Input Name	CH 01
- Isolate	Disabled
- Type	Mono
- DirectOut Pre/Post	Unused
Patching	
- Input Patch	MIC 01
- DirectOut Patch	Unused
Global Post/Pre	
- Set Global Post/Pre	Click To Select



Name

Name the selected input channel.

When the Name field is selected, a QWERTY keyboard will appear on the Touch Screen so you can enter the desired name.



Isolate

Isolate this channel from automation playback.

When a new cue is loaded, this channel will not be affected and its setting will not be changed. However, current channel settings are still stored when a cue is stored.
Please note: To prevent conflict, Isolation function does not include 48V and pre-amp gain.



Type

An input channel can either be Mono, Linked, or Stereo.

Stereo channels on this console are fixed as ST1 - ST6 and therefore the Type parameter is not editable. Mono Channels can be linked in consecutive Odd/Even pairs. Linked mono channels act in unison though the 48V and phase buttons, and the Delay, Gain, and Pan controls remain independent.

CHANNELS & BUSSES > INPUT CHANNELS > SETUP



DirectOut Pre/Post

Choose whether the Direct Output patch is sourced Pre Filter or Post Filter.

Post Filter is immediately after the HPF (High Pass Filter) but before the main EQ and Dynamics processing stages. Pre Filter is immediately after the Analogue To Digital conversion, before the Trim, Phase, and Delay stages.



Input Patch

Choose a physical input for this input channel.

Touching the value field will bring up the standard Patching setup on the Touch Screen. For more detail, please see section 5 - Inputs & Outputs.



DirectOut Patch

Choose a physical output for this channel's Direct Output.

Touching the value field will bring up the standard Patching setup on the Touch Screen. For more detail, please see section 5 - Inputs & Outputs.



Set Global Post/Pre

Set a global Pre- or Post-Fader routing for all Mix bus contributions from the input channel.

Alternatively, the Pre- or Post-fader routing can be set individually for the each Mix Bus contribution. This setting can be overridden by the Output Bus setup. Also, there are two options for Pre-Fader routing, which are selected in the Output Bus setup menu.



MIX 1-14 Pre/Post

Set individual Pre- or Post-Fade routing to Mix Busses 1-14.

There are two options for Pre-Fader routing. This is selected in the Output Bus setup menu.

CHANNELS & BUSSES > MIX OUTPUTS

All contributions to a Mix Bus are summed into Mix Bus Master DSP Channels (MIX 1-14). They have various uses, including feeding auxiliary effects, as monitoring mixes, or creating unique mixes for zoned areas, contribution to the main mix, and more.

They can be mono (MIX 1-14) or stereo (MIX 9 -14) and they receive input from the each of the MIX 1-14 busses. In other words, Mix Master 1's input is the sum of the contributions to the MIX 1 Bus (from the Input channels).

Mix Master channels can contribute to the Matrix (MTX) 1-4 busses, the Main LR and Mono mix buses (via the Fader) and be patched to a physical output. Contributions to the Matrix busses are accessed via the tOTEM (FADER FOLLOW) buttons when a Mix Master Control Channel is selected.

You can access Mix Master channels via the Fader Layers (FADERS) button group or by selecting the bus mix via the tOTEM (FADER FOLLOW) buttons. The Fader Layer C is the default layer for the Mix Masters, though remember that control channels can be assigned to any channel you require.

All Mix Master channels include a Graphic Equaliser, though do not use the ACS mic/line input controls (48V, trim), and they do not have a Gate processing element.

Please note, Mix Masters cannot contribute to the FX 1-4 busses, or themselves, so the MIX, and FX FADER FOLLOW buttons are not applicable for Control Channels assigned to Mix Masters.

There are various output-specific options, found via the Touch Screen Main Menu OUTPUTS & DMX button. These offer channel naming, isolate, Pre/Post routing options, width (stereo/mono) and physical output patching. See section 6.2.1.

CHANNELS & BUSSES > MIX OUTPUTS

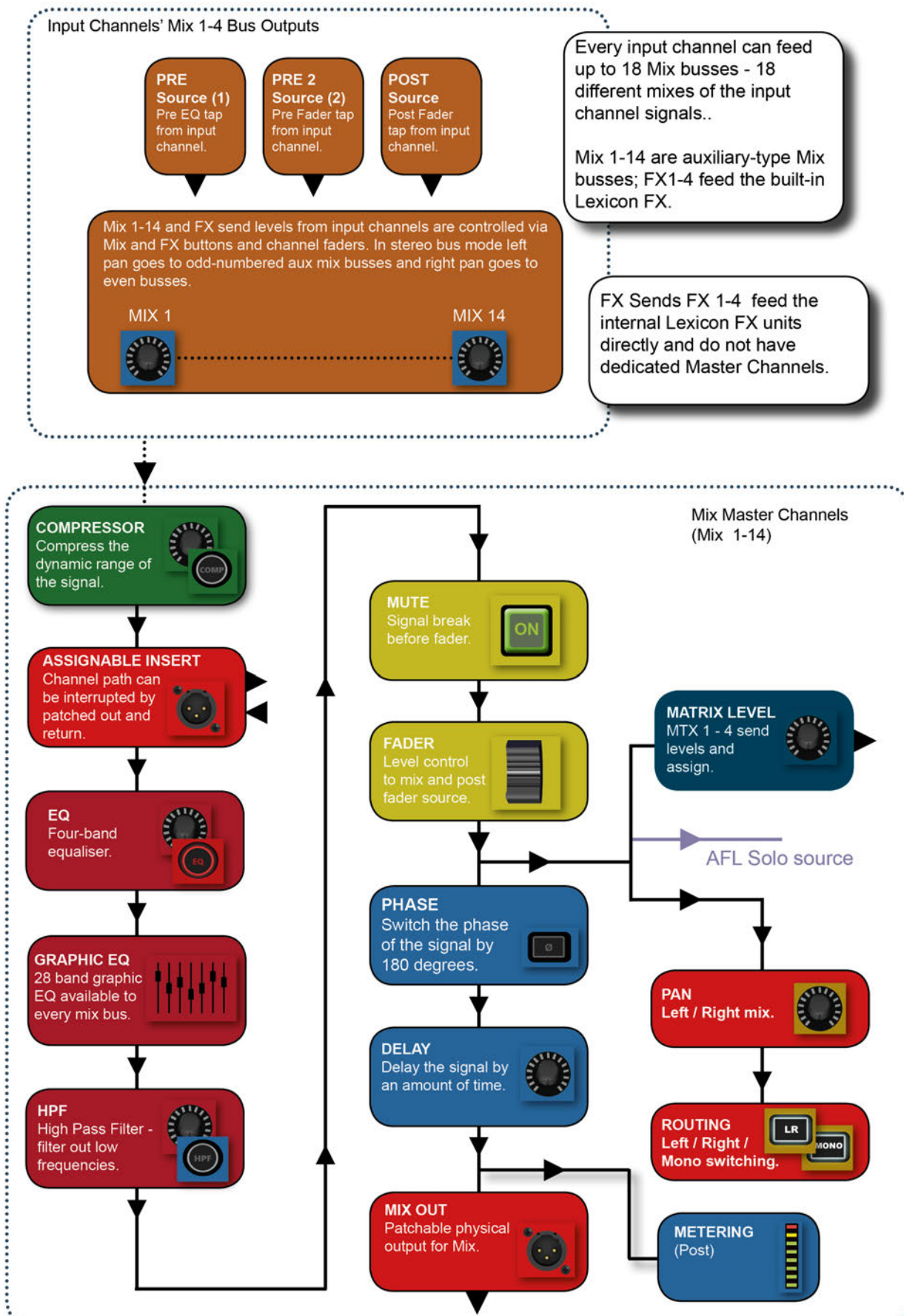

CHANNELS & BUSSES > MIX OUTPUTS > SETUP

There are various Mix Output-specific options, found via the Touch Screen Main Menu OUTPUTS & DMX button (when an Output Channel is selected). These offer channel naming, isolate, Pre/Post routing options, width (stereo/mono) and physical output patching.

MIX 10 SETUP	
General	
- Mix Name	MIX 10
- Isolate	Disabled
- Mix Width	Stereo
Bus Sends	
-Set Mix Sends Pre/Post	Click To Select
Pre Fader Source	Post EQ
Patching	
- Output Patch 01 Left	O/P 10
- Output Patch 01 Right	Unused



Name

Name the selected Mix Bus.

When the Name field is selected, a QWERTY keyboard will appear on the Touch Screen so you can enter the desired name.



Isolate

Isolate the Mix Bus Master DSP Channel from automation playback.

When a new cue is loaded, this DSP Channel will not be affected and its settings will not be changed. However, current channel settings are still stored when a cue is stored.



Mix Width

Select Mono or Stereo width for this Mix Bus.

Note, only Mix busses 7-14 can be switched to stereo. Mix busses 1-8 are mono only.

CHANNELS & BUSSES > MIX OUTPUTS > SETUP

**Set Mix Sends Pre/Post**

Set all contributions to the Mix Bus Pre- or Post-Fade.

This setting can override settings made in the Input Channel Setup.

**Pre Fader Source**

Select which Pre-Fader tap/source is used to supply this Mix Bus.

Only relevant when a Pre-Fade routing is selected in the Input or Output Bus Setup menus. The choices (since console software version 1.6 either Pre Dynamics or Post EQ (but still pre-mute)).

**Output Patching**

Choose specific analogue or digital outputs for this DSP Channel.

Touching the value fields will bring up the standard Patching setup on the Touch Screen. Two outputs can be allocated, with individually patchable left and right connections. For more detail, please see section 5 - Inputs & Outputs.

CHANNELS & BUSSES > MATRIX OUTPUTS

The Matrix busses feed the Matrix Master channels. Matrix Busses can be used for many things, including a convenient way to send the same Mix to several monitor destinations at differing levels; or to use as an alternative main mix of mix groups to feed additional front of house zones.

Matrix Master channels receive their input from the Matrix (MTX) 1-4 busses, which can be fed by the MIX 1-14 Master channels and/or the Left, Right, and Mono main mix outputs.

The Matrix busses and masters are stereo, and the Matrix Master channels have two patchable stereo outputs each (Left and Right of both outputs are interdependently patchable).

All Matrix channels include a Graphic Equaliser, though do not use the ACS mic/line input controls (48V, Gain/Trim, Phase), and they do not have a Gate processing element.

Please note, Matrix Masters can not contribute to the MIX 1-14 busses, FX 1-4 busses, the Left/Right and Mono

Main Mix busses, or themselves, so the MIX, FX, and MTX FADER FOLLOW buttons are not applicable for Control Channels assigned to Matrix Masters.

There are various Matrix output-specific options, found via the Touch Screen Main Menu OUTPUTS & DMX button. These offer naming, isolate, width, and physical output patching. See section 6.3.1.

CHANNELS & BUSSES > MATRIX OUTPUTS

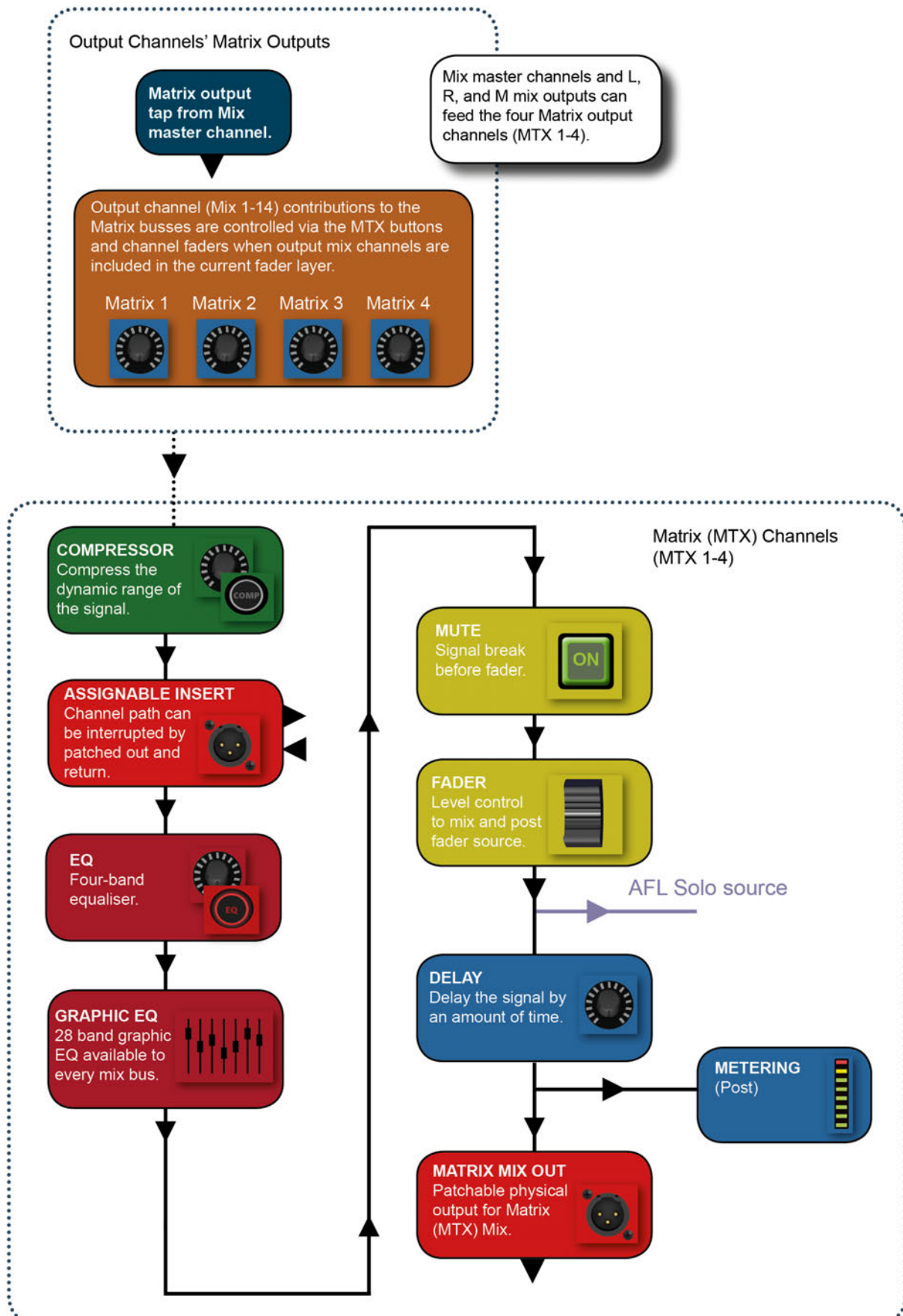

CHANNELS & BUSSES > MATRIX OUTS > SETUP

There are various Matrix output-specific options, found via the Touch Screen Main Menu OUTPUTS button. These offer naming, isolate, width, and physical output patching.

MATRIX 03 SETUP	
General	
- Matrix Name	MTX 03
- Isolate	Disabled
- Matrix Width	Stereo
Patching	
- Output Patch 01 Left	Unused
- Output Patch 01 Right	Unused
- Output Patch 02 Left	Unused
- Output Patch 02 Right	Unused



Name

Name the selected Matrix Bus.

When the Name field is selected, a QWERTY keyboard will appear on the Touch Screen so you can enter the desired name.



Isolate

Isolate the Matrix Master DSP Channel from automation playback.

When a new cue is loaded, this channel will not be affected and its setting will not be changed. However, current channel settings are still stored when a cue is stored.



Matrix Width

Choose Mono or Stereo type for the Matrix Master Output.



Patching

Choose specific analogue or digital outputs for the Master Output Channel.

Touching the value fields will bring up the standard Patching setup on the Touch Screen. Two outputs can be allocated, with individually patchable left and right connections. For more detail, please see section 5 - Inputs & Outputs.

CHANNELS & BUSSES > MAIN MIX OUTPUTS

The Main Left, Right, and Mono/Centre (L/R & M/C) busses and master channels are used for the main mix output and receive their inputs from the Input Channels and Mix Bus Master channels.

The Left and Right busses feed the main Left/Right Master - a Stereo Output DSP Channel - which is permanently assigned to the Left/Right Control Channel. The Mono bus feeds the main Mono output channel, which during normal operation is controlled by the MONO/SEL control channel, though that channel is assigned to bus masters in FADER FOLLOW mode.

The Left/Right and Mono channels include a Graphic Equaliser, though do not use the ACS mic/line input controls (48V, Gain/Trim, Phase), and they do not have a Gate processing element.

There are various Main Left/Right and M-specific options, found via the Touch Screen Main Menu OUTPUTS button. These offer naming, isolate, and physical output patching.

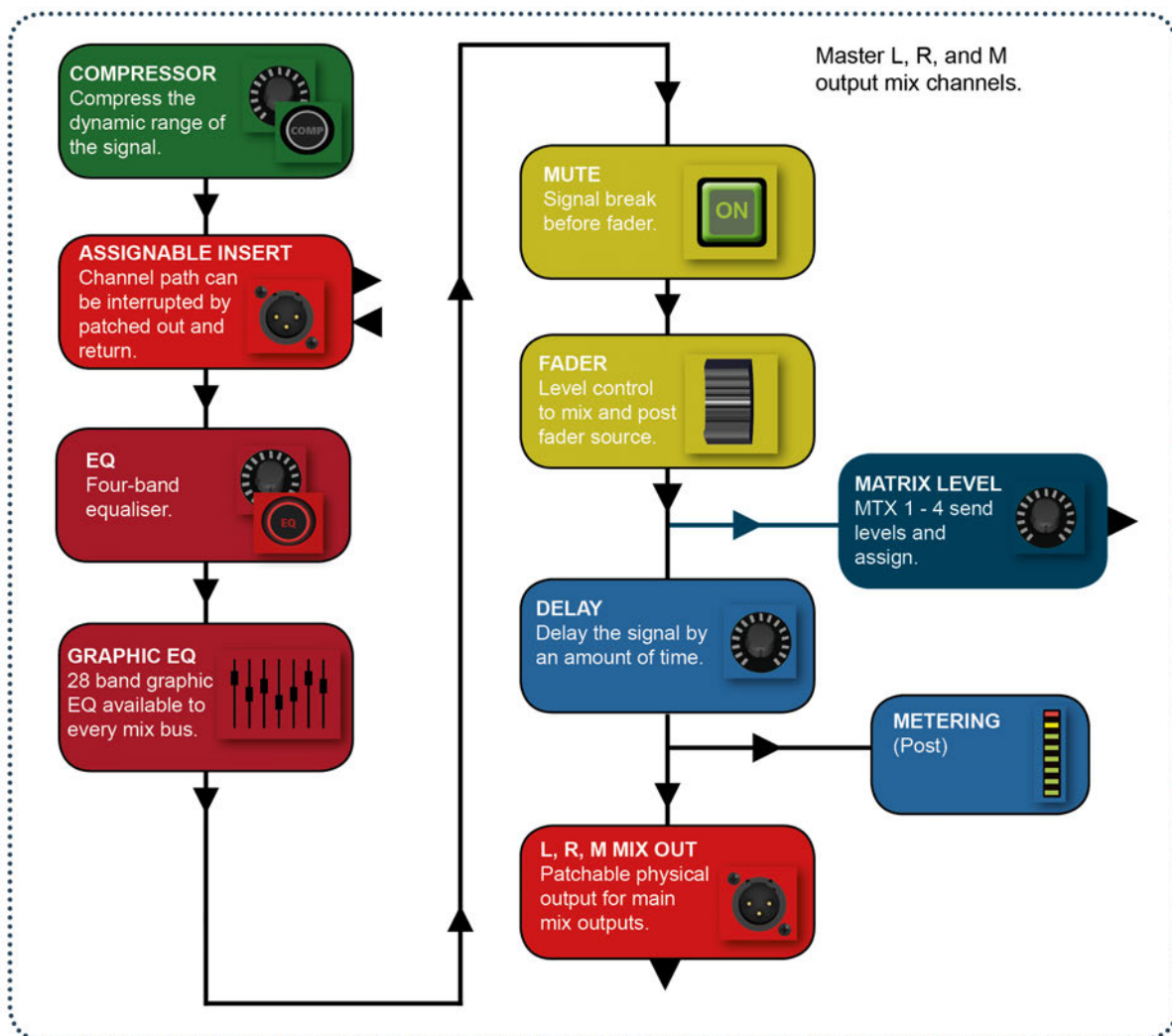

CHANNELS & BUSSES > MAIN MIX OUTS > SETUP

There are various Main Left/Right and Mono-specific options, found via the Touch Screen Main Menu OUTPUTS button. These offer naming, isolate, and physical output patching.

MAIN LEFT & RIGHT SETUP	
General	
- Main LRC Name	L&R
- Isolate	Disabled
Patching	
- Patch 01	O/P 15
- Patch 02	AES Out01



Name

Name the selected Main Output Bus.

When the Name field is selected, a QWERTY keyboard will appear on the Touch Screen so you can enter the desired name.



Isolate

Isolate the Main Output Master DSP channel from automation playback.

When a new cue is loaded, this DSP channel will not be affected and its setting will not be changed. However, current channel settings are still stored when a cue is stored.



Patching

Choose specific analogue and digital outputs for this DSP Channel.

Touching the value fields will bring up the standard Patching setup on the Touch Screen. Two outputs can be allocated for both the L&R and the M channels. For more detail, please see section 5 - Inputs & Outputs.

CHANNELS & BUSSES > FX Busses

The FX Send busses (FX 1-4) are used exclusively to feed the internal Lexicon FX units. They receive input from the Input Channels. Those contributions are accessed via the FX 1-4 tOTEM (FADER FOLLOW) buttons.

Management of the Lexicon FX is done via the LEXICON button group the FX button (Lexicon FX setup).

Please see section 10 for more details.



DSP CHANNEL ELEMENTS

Input and output (Bus Master) DSP channels share many common DSP processing elements and controls via the Control Channel and Assignable Control Section (ACS). This chapter explains those elements and their controls. Please note, some elements will not be available (will be unlit and inactive) on certain channel types (Master Output Channels have no Gate section, for example).

DYNAMICS
A Full featured dynamics section with gate and compressor. A sidechain input with hi- and lo-pass filters allows frequency-dependent control for functions like de-essing, persussion gates, and so on.

EQUALISER
A Four-Band EQ for detailed control over the tone of your audio. The High and Low frequency bands are shelving filters, while the Lo-Mid and Hi-Mid bands are fully parametric 'bell' type filters.

Encoder
Gain/Trim, HPF Filter, or Pan / balance.

Metering
Channel signal level and status indication.

ON
Channel active / mute.

SEL
Select Channel.

SOLO
Solo this channel.

Channel Fader
Channel's output level to Mix, or bus contribution when used with TOTEM (FADER FOLLOW).

INPUT SECTION
Mic and line input control including phantom power, phase invert, gain / trim, and hi-pass filter.

OUTPUT SECTION
Delay, panning / balance, plus Left / Right and Mono main mix bus routing.

IN
dBfs
-3
-6
-9
-12
-15
-18
-21
-24
-27
-30
-33
-36
-39
-42
-45
-48
-51
-54
L/MONO R
ABV
GAIN/TRIM
HPF
GATE
ATTACK
RELEASE
DEPTH
THRESHOLD
COMP
ATTACK
RELEASE
THRESHOLD
EQUALISER
HF
FREQ
Q
LF
FREQ
Q
LM
FREQ
Q
HF
FREQ
Q
OUT
DELAY
PAN
LR

0dB
1 -12
5 -14
10 SIG

ON
SEL
SOLO

10
5
0
5
10
15
20
25
30
40
60
∞
60

DSP ELEMENTS > FUNCTION FOCUS

Function Focus allows pinpoint adjustment of any controls and settings by automatically detailing the value of both the control you are currently adjusting and any other controls in its group, plus the channel name and alternate units for the same control.

For example, DELAY is illustrated in ms (milliseconds), feet, and meters, while EQ filter 'Q' is shown as both Q and bandwidth (octaves).

The Function Focus display can be 'pinned' (displayed even when the control is inactive) to the screen by touching it while it is displayed. Touching it again will unpin it.

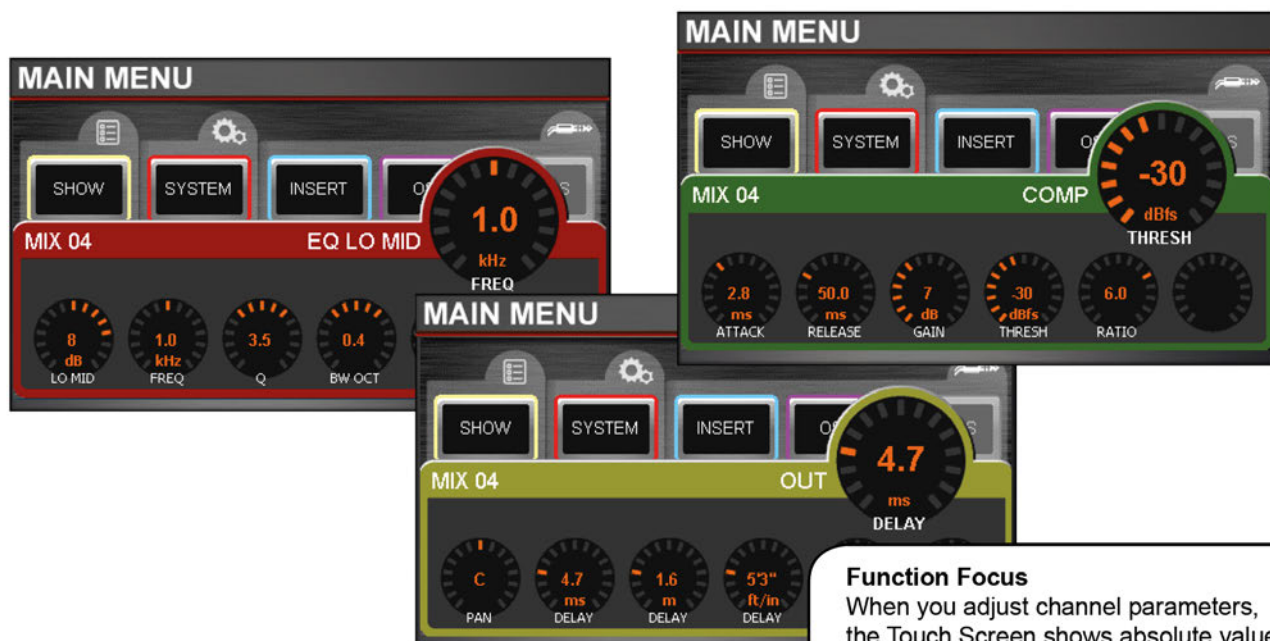

Function Focus
 When you adjust channel parameters, the Touch Screen shows absolute value, plus other relevant information and values.

DSP ELEMENTS > ACS ELEMENTS

The Assignable Channel Strip (ACS) follows the currently selected DSP Channel and provides almost all of the controls relating to that. It is broken down in to small colour coded sections making it easy to identify control groups and functions at a glance.



There is a dedicated control for each function and each control has a dedicated label and scale, just as you would find on an analogue mixer

The exact value of any control will be shown on the Touch Screen using the Function Focus feature (see section 7.1) as you adjust them.



The input section mainly provides the features required for input channels such as phantom power and mic/line level. Metering is applicable to all DSP Channel types, and HPF (High Pass Filter) is available in Auxiliary Mix master channels.



Metering

Signal level in channel shown as dBfs

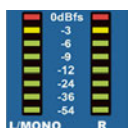

Stereo channels use both L and R bargraphs, mono channels use the L/MONO bargraph. The scale is relative to digital 'full scale', so 0dBfs is the maximum before clipping. For input channels, the meter source is 'PRE' (just after the analogue-to-digital conversion but before the rest of the channel processing) so you can adjust for optimum Gain. The output/bus channel metering source is 'POST' (just before the physical output).



48V Phantom Power

Turn 48V phantom power supply on or off.



This only works for Input Channels patched to mic inputs and supplies the 48V necessary to polarise condenser (capacitor) microphones. Pressing and holding the key will activate Interrogate mode for this function (see the Mix Features section 8.3).

DSP ELEMENTS > ACS > INPUT



Phase Invert

Invert signal phase (180 degrees).

Pressing and holding the key will activate Interrogate mode for this function (see Mix Features 8.3).



GAIN/TRIM

Adjust mic gain or line trim for input channels.

The control changes its function depending on the selected input. Mic Gain (-5dB - +58dB) is applied in the analogue domain, before analogue-to-digital conversion. It is only applicable to Microphone inputs. Line input trim is applied after conversion (-10dB/+16dB).

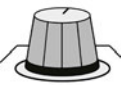

HPF Frequency

Adjust the cut-off (-3dB) frequency of the High Pass Filter.

This filter 'cuts' low frequencies according to an 18dB/Oct slope that turns down just before the cut-off frequency. Use it to filter out low frequency 'rumble' and clean up live microphone feeds, for example.

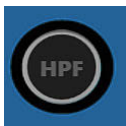

HPF On/Off

Switches the High Pass Filter on and off.

Pressing and holding the key will activate Interrogate mode for this function (see Mix Features 8.3).

DSP ELEMENTS > ACS > GATE



A Gate is a threshold-driven gain reduction process normally used to attenuate a signal when its level falls below the Threshold. Setting the Threshold just above a noise floor or background noise, for example, will allow the Gate to attenuate the source during periods when the main input (voice, instrument etc) is silent.

This gate includes a Sidechain Filter section. This allows you to control what frequency range is compared to the threshold level. For instance, you could limit the sidechain range to only 'Ess' vocal frequencies. In conjunction with a carefully set threshold this would act as an effective 'broadband' De-Esser.



ATTACK

Adjust the Attack time of the Gate

The time taken for the limiter to reach full attenuation.



RELEASE

Adjust the Release time of the Gate

The time taken for the limiter to return to zero attenuation after limiting.



DSP ELEMENTS > ACS > GATE

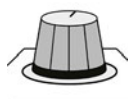

DEPTH

Adjust the Depth value of the Gate

The amount of attenuation applied when the gate is closed.



THRESHOLD

Adjust the threshold of the Gate

The signal level of the sidechain at which the gate is activated.



S/C LPF

Adjust the Sidechain Low Pass Filter

This filter cuts high frequencies from the sidechain signal, limiting the frequency range of the signal that is 'tested' by the threshold setting.



S/C HPF

Adjust the Sidechain High Pass Filter

This filter cuts out low frequencies, limiting the frequency range of the signal that is 'tested' by the threshold setting.



Gate Status LEDs

Indicate the current operating status of the gate

OPEN (inactive - the gate is passing signal and audio is above the threshold), HOLD (the gate is passing signal but audio is below the threshold, the gate will close soon), SHUT (audio is below threshold and the gate is closed - the audio is attenuated according to the DEPTH control value).



GATE On/Off

Switch the gate process On and Off

Pressing and holding the key will activate Interrogate mode for this function (see Mix Features 8.3).





A compressor is a threshold driven process used to reduce the dynamic range of a signal by applying gain reduction when the signal level exceeds the threshold and applying 'make-up gain' to keep the overall level consistent.

You can use compression to increase the apparent loudness of a signal without increasing the peak level, or to control overly dynamic sources.



ATTACK

Adjust the Attack time of the Compressor

The time it takes for the compression function to reach full attenuation after the threshold has been reached. The slower the attack time, the 'softer' the compression for less audible 'pumping' (abrupt, repetitive changes in level).



RELEASE

Adjust the Release time of the compressor

The time it takes for the attenuation (compression) to return to zero after the signal has returned to below the threshold. Longer release times will soften the compression and reduce audible 'pumping' (abrupt, repetitive changes in level).



DSP ELEMENTS > ACS > COMPRESSOR



GAIN

Adjust the make-up gain of the Compressor

Gain applied after the compressor to account for level lost in compression.



THRESHOLD

Adjust the Threshold level of the compressor

When the signal exceeds the threshold, it will be attenuated according to the ratio setting.

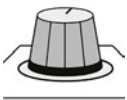

RATIO

Adjust the Ratio value for the Compressor

The ratio between the amount that the normal signal level has exceeded the threshold and the level above threshold it will be attenuated to. For example, if the threshold is set at -10dB and the ratio is set to 2:1, when a signal level of 0dB (10dB above threshold) comes in, it will be attenuated to -5dB (5dB above threshold, which is 10dB divided by 2). In the same instance, if the ratio was 5:1 then the signal would be attenuated to -8dB, which is 2dB above threshold (10dB divided by 5). Essentially, the higher the ratio, the more the signal is 'squashed'.



Gain Reduction Meter

Indicates amount of gain reduction currently being applied by the compression process.

The meter will show how much the signal is currently being attenuated. That is, the more lights that are on, the more compression is being applied.

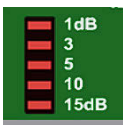

COMP On/Off

Switch the compression process on or off.

Pressing and holding the key will activate Interrogate mode for this function (see the Mix Features 8.3).



DSP ELEMENTS > ACS > EQUALISER



The channel EQ (Equaliser) section is used for sculpting the tonal (frequency-based) balance of the signal. The expression EQ is a four-band type with two (Hi and Lo) Shelving filters, and two (Hi Mid and Lo Mid) fully parametric 'bell' filters.



HF Level

Adjust the boost/attenuation of the HF shelving filter.

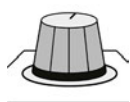

HF FREQ

Adjust the centre frequency of the HF shelving filter.

The filter will boost or cut the signal at this frequency by the amount set by HF Level. The cut-off frequency will be lower, according to the filter slope.



DSP ELEMENTS > ACS > EQUALISER

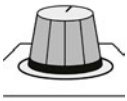

HI MID Level

Adjust the boost/attenuation of the HI MID filter.



HI MID FREQ

Adjust the centre frequency of the HI MID filter.



Frequencies above and below this, within the bounds of the Q setting will be affected by the HI MID level control. That is, Q effectively sets the 'width' (bandwidth) of the filter's bell shape and FREQ sets the frequency at the centre of the bell shape.

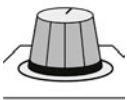

HI MID Q

Adjust the Q of the HI MID Filter

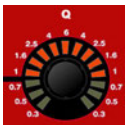

Q is 'magnification' at resonance, and is inversely proportional to bandwidth. For an equaliser it is useful to think of it simply as a bandwidth control (the width of the 'bell' in the case of a bell-shaped filter). That is, the higher the Q, the lower the bandwidth - or the more 'focussed' the filter. Bandwidth (in octaves) is shown on the Touch Screen with the Function Focus feature.



LO MID Level

Adjust the boost/attenuation of the LO MID filter.



LO MID FREQ

Adjust the centre frequency of the LO MID filter.



Frequencies above and below this, within the bounds of the Q setting will be affected by the LO MID level control. That is, Q effectively sets the 'width' (bandwidth) of the filter's bell shape and FREQ sets the frequency at the centre of the bell shape.

DSP ELEMENTS > ACS > EQUALISER



LO MID Q

Adjust the Q of the LO MID Filter

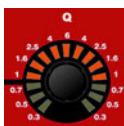

Q is 'magnification' at resonance, and is inversely proportional to bandwidth. For an equaliser it is useful to think of it simply as a bandwidth control (the width of the 'bell' in the case of a bell-shaped filter). That is, the higher the Q, the lower the bandwidth - or the more 'focussed' the filter. Bandwidth (in octaves) is shown on the Touch Screen with the Function Focus feature.



LF Level

Adjust the boost/attenuation of the LF shelving filter.



LF FREQ

Adjust the centre frequency of the LF shelving filter.



The filter will boost or cut the signal at this frequency by the amount set by LF Level. The cut-off frequency will be higher, according to the filter slope.



EQ On/Off

Switch the EQ process for this channel On and Off.



Pressing and holding the key will activate Interrogate mode for this function (see Mix Features 8.3).

7.2.5: ACS OUTPUT SECTION

DSP ELEMENTS > ACS > OUTPUT



The outputs section contains features specific to the outputs of all channels. Delay and Pan (or balance) are applicable to all channel types, while LR and MONO routing is specific to input and Aux Mix master channels (not Matrix master channels).



DELAY

Adjust the delay applied to the output of this DSP channel.



ACS units are milliseconds, though the Touch Screen will show feet and meters as well, with the Function Focus feature.



PAN

Adjust the Pan (or balance for stereo channels) of the DSP Channel or Bus routing to the main Left/Right bus.



The Pan control operates for channel-to-Left/Right, Mix Bus-to-Left/Right, or as a balance control when the Left/Right Master Channel is selected. Note: Pan from a channel to a mix or a mix to matrix feed is always controlled by the global mode encoders when a TOTEM (FOLLOW FADER) key is active.

DSP ELEMENTS > ACS > OUTPUT



LR (Main Left Right Bus Routing)

Route the selected channel to the Main Left/Right Stereo Bus.

Any channels routed to LR will be summed into the Main LR Master Output Channel, controlled by the L&R Control Channel.



M (Main Mono Bus Routing)

Route the selected channel to the Main Mono Bus.

Any channels routed to M will be summed (Mono) into the Main M/C Master Output Channel, controlled by the M Control Channel.



DSP ELEMENTS > CONTROL CHANNEL

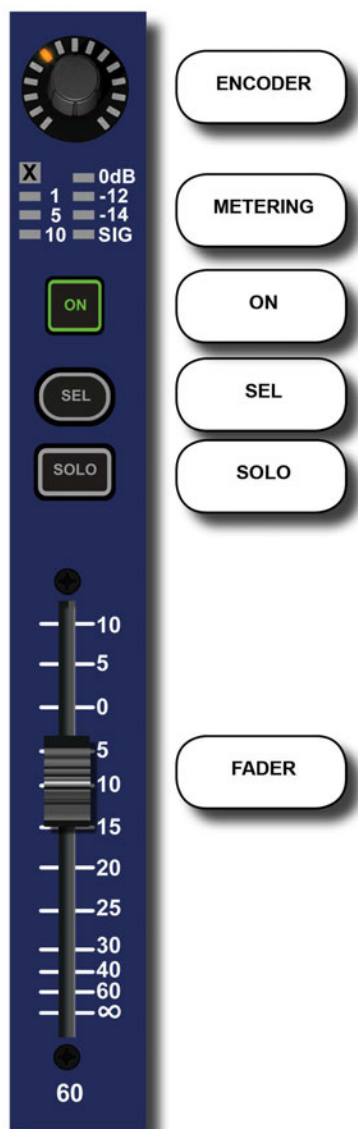

Control channels contain the primary performance controls and indicators. Layers of Control Channels (assigned to various 'actual' channels) are selected using the FADERS (Fader Layers) button group. Control channel positions are assigned to channels using the Touch Screen FADER SETUP menu.



Encoder

Control 'GAIN', 'FILT', or 'PAN' depending on the Global Encoder Mode selection

GAIN: Encoders function as the input GAIN (or TRIM for line & digital sources) for all the channels on the currently active fader layer. No function in for Mix Bus or Matrix masters.

FILT: Encoders function as the input HPF (frequency adjust) for all the channels on the currently active input fader layer. No function for Matrix masters.

PAN: Encoders function as the Pan or Balance for all the channels or buses on the channels on the currently active fader layer. When using the tOTEM (FADER FOLLOW) keys the global encoders act as the Pan or Balance control from the channels to the busses and as balance on stereo Matrix Masters.



DSP ELEMENTS > CONTROL CHANNEL



Gate Closed (X)

Indicates the selected channel's gate is closed.

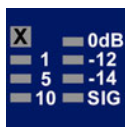

Gain Reduction Meter

Indicates gain reduction for the selected channel.

These are the three LEDs on the left side labelled 1, 5, 10 (dB of attenuation).



Level Meter

Indicates audio level for the selected channel - dBfs



ON

ON key function is dependant on the channel type and selected fader layer. Momentary / Latching behaviour available from software version 1.6 (see below).

Audio channel/ bus master: Turns channel on (Green) or off (Unlit). When the channel is muted by a Mute group, the ON button will be red.
 Follow Mode (tOTEM/FADER FOLLOW button selected): Switches the send from that channel to the selected bus on or off.
 GEQ Mode (GEQ HI or GEQ LO FADERS button selected): Resets the GEQ band to 0dB. ON button will be red when a GEQ band is 'active' (non-zero).

In Audio Channel and Fader Follow modes, holding an INACTIVE On button down will make the switch 'momentary' (it will turn off again when you release it). This facilitates talkback (input channel) and audition bus (MIX/MTX) functionality.



SEL

Select this Control Channel.

In normal operation this selects the channel or mix master channel, switching the ACS to that channel and focusing the Touch Screen onto that channel. In other modes, the SEL keys are used to select channels for inclusion or functionality, such as Mute Group setup or during an Interrogate operation.



DSP ELEMENTS > CONTROL CHANNEL



SOLO

Press to Solo this DSP Channel (Input Channel, Mix Bus Master, Matrix Master).

See section 8.4 for more information of the console's Solo system.



FADER

Adjust signal level.

Audio channel / Mix Master: Master level.

FOLLOW MODE (tOTEM button selected): Send level form channel to selected bus.

GEQ Mode (GEQ HI or GEQ LO FADERS button selected): GEQ band gain.

The console uses motorised faders to recall position when switching Fader Layers and so on. If a Control Channel is unassigned, the fader will resist movement.

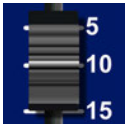

DSP ELEMENTS > GRAPHIC EQ (GEQ)

28-Band Graphic Equalisers (GEQs) are available to all Output Masters on the console: Mix Bus, Matrix Bus, and Left/Right and Mono Bus masters. All Output Masters can run GEQs simultaneously.

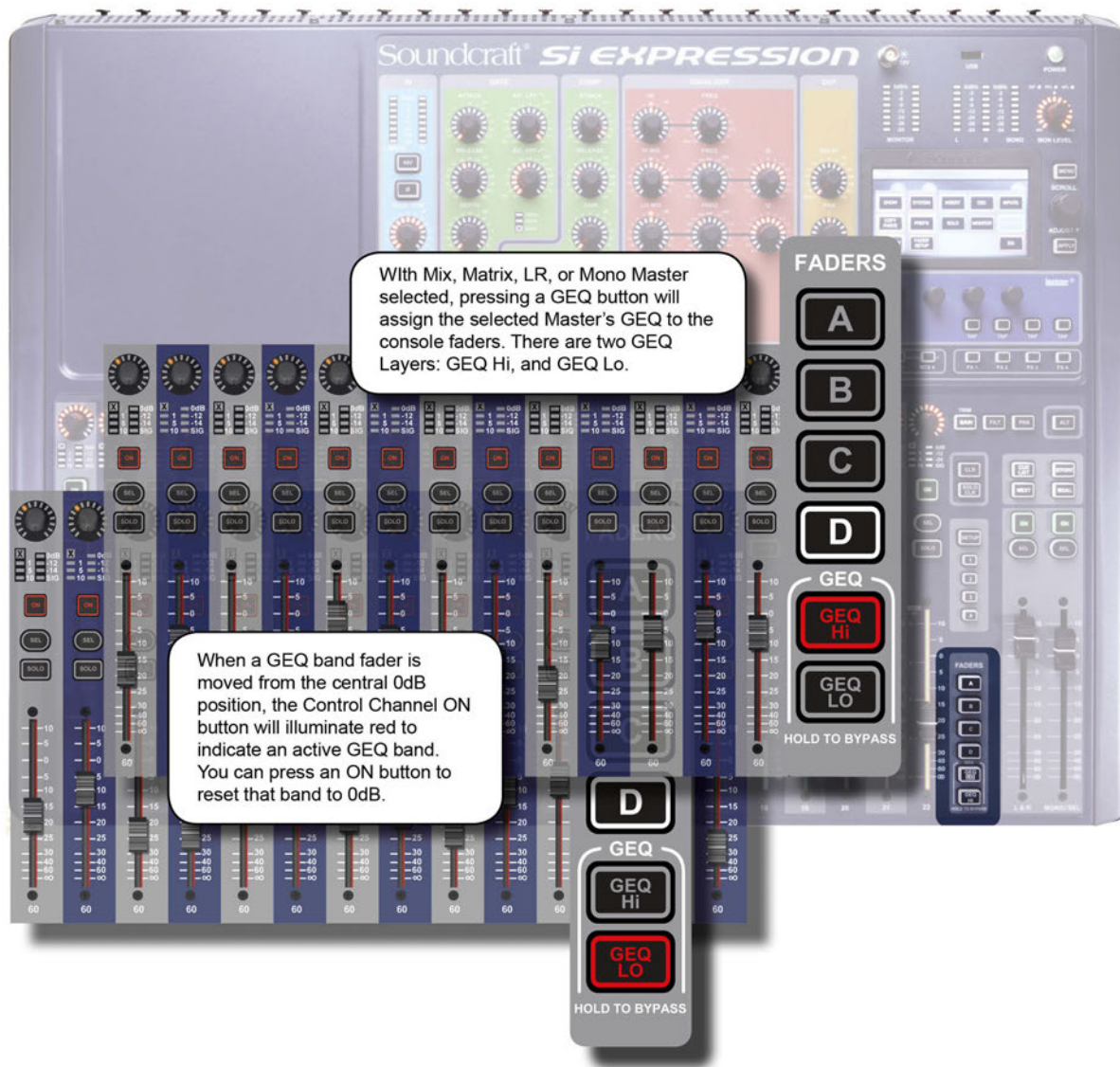

When any output channel is selected, the GEQ LO and GEQ HI buttons (FADERS button group) will assign 14 bands to the Control Channel Faders, colour-coded with red FaderGlow. Faders are centre (0dB position) detented with in use as GEQ bands.

The Bands for High and Low GEQ sections are marked above the relevant Faders and Function Focus will activate when a band is adjusted (remember - in software version 1.6 and above the function focus display can be 'pinned' by touching it when active).

DSP ELEMENTS > GRAPHIC EQ (GEQ)

When a band is moved from its zero position (0dB) the Control Channel ON button will light red to show that band is active. You can press a red ON button to 'zero' that band.

A channel's Graphic EQ setting does not affect the Touch Screen EQ response graphic (EQ Main Menu button).



GEQ HI

Press to assign the 14 'high' GEQ bands (800Hz - 16kHz) to the Control Channel Faders.



An output channel (Mix Bus, Matrix Bus, LR / Mono bus masters) must be selected for this button to have any effect.



GEQ LO

Press to assign the 14 'low' GEQ bands (31Hz - 630Hz) to the Control Channel Faders.



An output channel (Mix Bus, Matrix Bus, LR / Mono bus masters) must be selected for this button to have any effect.



ON (red)

Lighted red to indicate an active (non-zero) GEQ band. Press to 'zero' that band.

This ON button mode is only active while GEQ is assigned to the faders.



CLR + GEQ

'Zero' all bands in the active GEQ.

Hold CLR and press either the GEQ HI or GEQ LO buttons to 'zero' (set to 0dB) all bands (both high and low).



FADER

Adjust the level of the assigned GEQ band.

The GEQ scale is shown on the left of the fader - +/-15dB, above and below a centre detented 0dB position. GEQ FaderGlow is Red. The two centre frequency options for the fader (GEQ HI and LO) are indicated on the panel, just above the fader.



MIX FEATURES

Si Expression Mix Features include mix functions outside the normal audio signal path: Mute Groups, Copy and Paste, Interrogate, the Solo system, Monitoring, and the CLR and ALT + CLR facilities.

8.1: Mute Groups

Set up groups of channels that can be muted with a single button press. You can create up to four mute groups, operated by the Mute Group Master buttons 1-4. Mute groups are cumulative so activating a second Mute Group Master will add those channels to the number of muted channels.

8.2: Copy & Paste

Copy then Paste whole channels, channel sections, FX settings, and Mix bus, FX send, and Matrix bus mixes. Press the PASTE button in the Touch Screen Main Menu to begin the process.

8.3: Audio Interrogate

Interrogate and change the status of ACS button across every channel simply by pressing and holding that button. For example, check the status of all channels in one go! Press and hold the button to enter Interrogate mode.

8.4: Solo System

Listen to individual channels on the monitor mix or main mix (Solo In Place). The automatic solo mode function chooses PFL or AFL depending on where one or more channels are soloed.

8.5: Monitoring

The Engineer's mix. Solo system integration, delay, mono check, and patchable outputs,

8.6: CLR & ALT + CLR

Special modifier buttons for clearing or resetting individual channel settings or settings across the whole console.



MIX FEATURES > MUTE GROUPS

Mute Groups enable group-muting of selected channels at any time. Create up to four Mute Groups operated from the Mute Group Masters button group. Use the Mute Group SETUP button, a Mute Group Master button, and channel SEL buttons to set up.

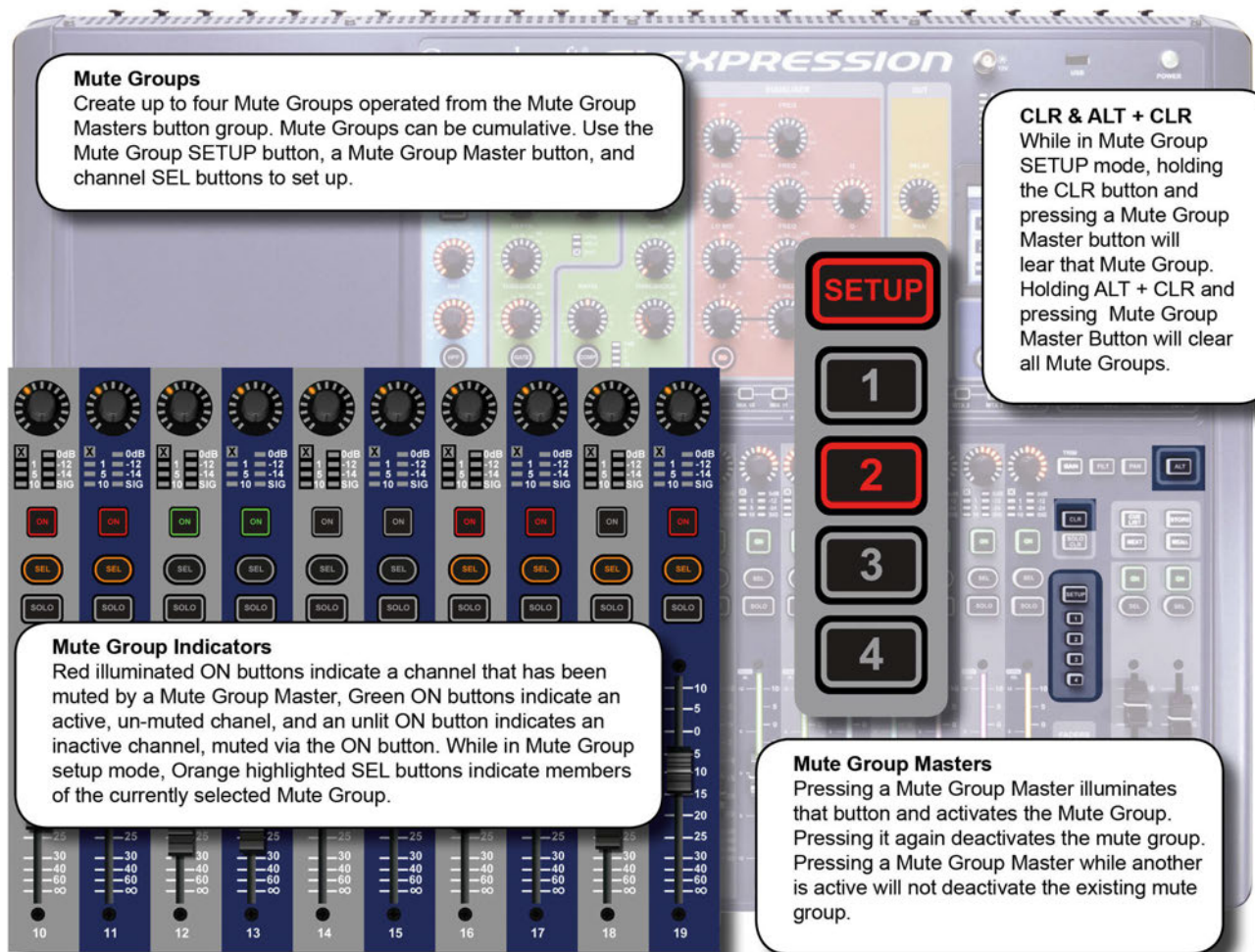

Mute Groups

Create up to four Mute Groups operated from the Mute Group Masters button group. Mute Groups can be cumulative. Use the Mute Group SETUP button, a Mute Group Master button, and channel SEL buttons to set up.

CLR & ALT + CLR

While in Mute Group SETUP mode, holding the CLR button and pressing a Mute Group Master button will clear that Mute Group. Holding ALT + CLR and pressing Mute Group Master Button will clear all Mute Groups.

Mute Group Indicators

Red illuminated ON buttons indicate a channel that has been muted by a Mute Group Master, Green ON buttons indicate an active, un-muted channel, and an unlit ON button indicates an inactive channel, muted via the ON button. While in Mute Group setup mode, Orange highlighted SEL buttons indicate members of the currently selected Mute Group.

Mute Group Masters

Pressing a Mute Group Master illuminates that button and activates the Mute Group. Pressing it again deactivates the mute group. Pressing a Mute Group Master while another is active will not deactivate the existing mute group.



Mute Group SETUP

Enter Mute Group SETUP mode.

This mode allows you to configure Mute Group assignments in conjunction with the Mute Group Masters' buttons 1-4. The button illuminates Red when active.



Mute Group Master

Select a Mute Group.

Press a Mute Group Master button to activate or deactivate a Mute Group either in normal or SETUP mode. In normal operation, Mute Groups can be selected cumulatively.



MIX FEATURES > MUTE GROUPS



SEL

Select Control Channels.

While in Mute Group SETUP mode, with a Mute Group Master active, use the Control Channel SEL buttons to choose which channels should belong to that Mute Group. Orange highlighted SEL buttons indicate members of the currently selected Mute Group.



CLR

Clear Selection.

While in Mute Group SETUP mode, holding the CLR button and pressing a Mute Group Master button will clear that Mute Group.



ALT + CLR

Clear all.

While in Mute Group SETUP mode, holding ALT + CLR and pressing Mute Group Master Button will clear all Mute Groups.



ON

Mute status indication.

Red illuminated ON buttons indicate a channel that has been muted by a Mute Group Master, Green ON buttons indicate an active, un-muted channel, and an unlit ON button indicates an inactive channel, muted via the ON button.



MIX FEATURES > COPY AND PASTE

This facility allows almost any processing section to be copied easily and quickly from a channel or bus and pasted to another channel or bus. You can also copy and paste the internal Lexicon FX settings and Aux, FX Send, and Matrix mixes.

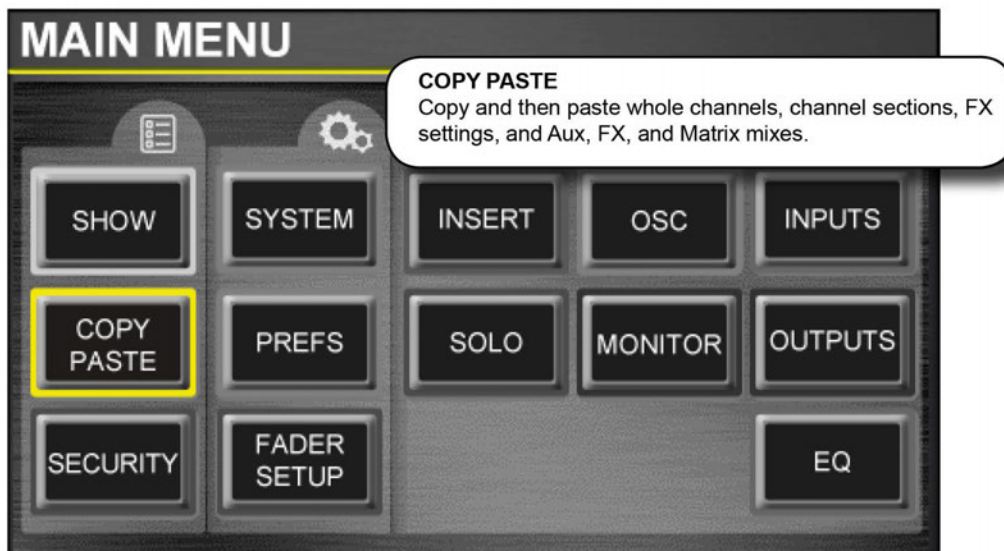

When you press COPY PASTE (Touch Screen Main Menu), or when you reselect a channel or bus while the COPY PASTE mode is active, the console's clipboard captures the state of that selection. If you have a channel selected, that channel's processing (except GAIN or 48V status') is copied; if you have a bus mix selected via the FADER FOLLOW (tOTEM) buttons, that bus mix is copied.



COPY PASTE

Copies the selected element to the console's clipboard.

Select a channel or Mix Bus to copy those to the clipboard. FX settings are selected by pressing the FX button while in Copy-Paste mode.



PASTE-HOLD

Hold and select a destination to paste the clipboard.

To paste DSP Channel settings, touch a SEL button, to paste a complete Mix Bus mix, touch a tOTEM (FADER FOLLOW) button, and to paste FX settings, touch the corresponding FX 1-4 tOTEM button (see following examples).



MIX FEATURES > COPY AND PASTE

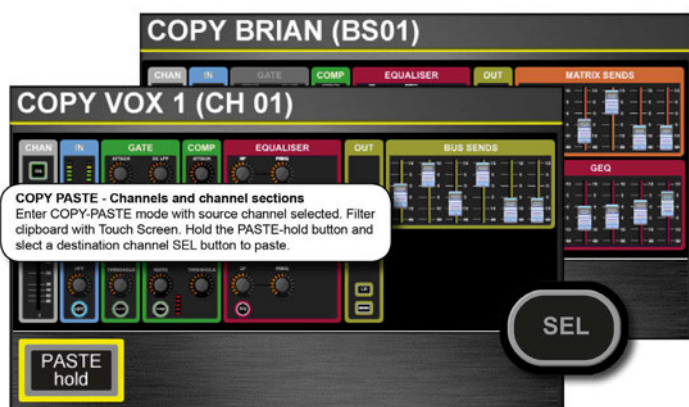

DSP Channel COPY-PASTE

With a DSP channel (Input Channel or Mix/Matrix Bus Master) selected, COPY PASTE mode will display a version of the ACS (with GEQ for Bus Masters). By touching sections in this Touch Screen display you can remove individual sections from the paste operation. To select a single section only, touch and hold that section in the Touch Screen.

To paste channels and channel selections, touch and hold the PASTE-hold Touch Screen button and choose another channel with its Control Channel SEL button.

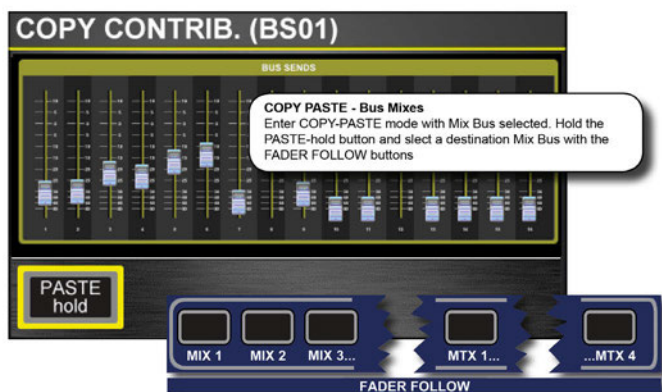

Mix Bus COPY-PASTE

With a tOTEM (FADER FOLLOW) button selected you can use COPY PASTE mode to copy and paste an entire MIX, MTX, or FX Bus Mix. For example, you could copy the MIX 1 contribution levels from all Input Channels and paste those levels as a MIX 2 mix). When you touch COPY PASTE, the mix to be copy-pasted will be shown in the Touch Screen display.

To paste a Bus mix, touch and hold the PASTE-hold Touch Screen button and choose another Bus mix via with tOTEM (FADER FOLLOW) buttons.



FX COPY-PASTE

To copy and paste settings between the four Lexicon processors, start by pressing the round FX button while in COPY-PASTE mode. This will display the four processors in the Touch Screen.

Select the processor you want to COPY - it will be highlighted in blue.

To paste, press and hold the Touch Screen PASTE-hold button, the select another processor with the four FX FADER FOLLOW (tOTEM) buttons - FX 1 - FX 4.

MIX FEATURES > AUDIO INTERROGATE

Audio Interrogate is a powerful method of checking and changing a particular switch status across all channels on the currently selected fader layer. For example, you can check at a glance which channels are routed to the main LR mix bus and change that status rapidly for all visible channels.

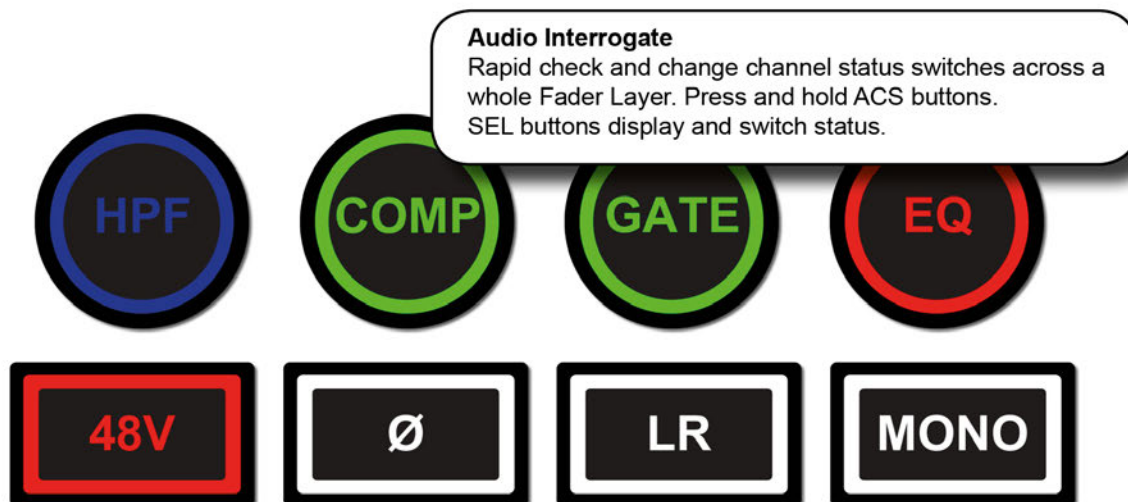

Audio Interrogate works for all status buttons on the Assignable Channel Strip:

- 48v ON/OFF
- Phase Reverse ON/OFF
- HPF IN/OUT
- GATE IN/OUT
- COMPressor IN/OUT
- EQ IN/OUT
- LR routing ON/OFF
- MONO routing ON/OFF

To Interrogate an ACS switch status:

- 1) Select a Fader Layer (FADERS) relevant to the switch status you wish to interrogate (for example, to interrogate LR routing of input channels, the current Fader Layer must include input channels).
- 2) Press and hold the ACS button for the chosen function (HPF, GATE, EQ, LR, and so on).

The SEL (Select) buttons of any channels where that function is active will light.

- 3) While holding the relevant ACS button, you can use the SEL buttons across that Fader Layer to change the status for each channel.

For example, if you select a Fader Layer containing input channels and you hold the 48V button down, the SEL buttons of any channels that have 48V Phantom Power enabled will illuminate. If you continue to hold the 48V button, you can then press the channel SEL buttons across the Fader Layer to toggle 48V on or off for each channel.

MIX FEATURES > SOLO SYSTEM

Solo provides a way of monitoring and checking individual channels and groups of channels quickly by routing only the 'soloed' channels either to the monitoring system (normal operation) or to the main mix outputs (Solo In Place - SIP).

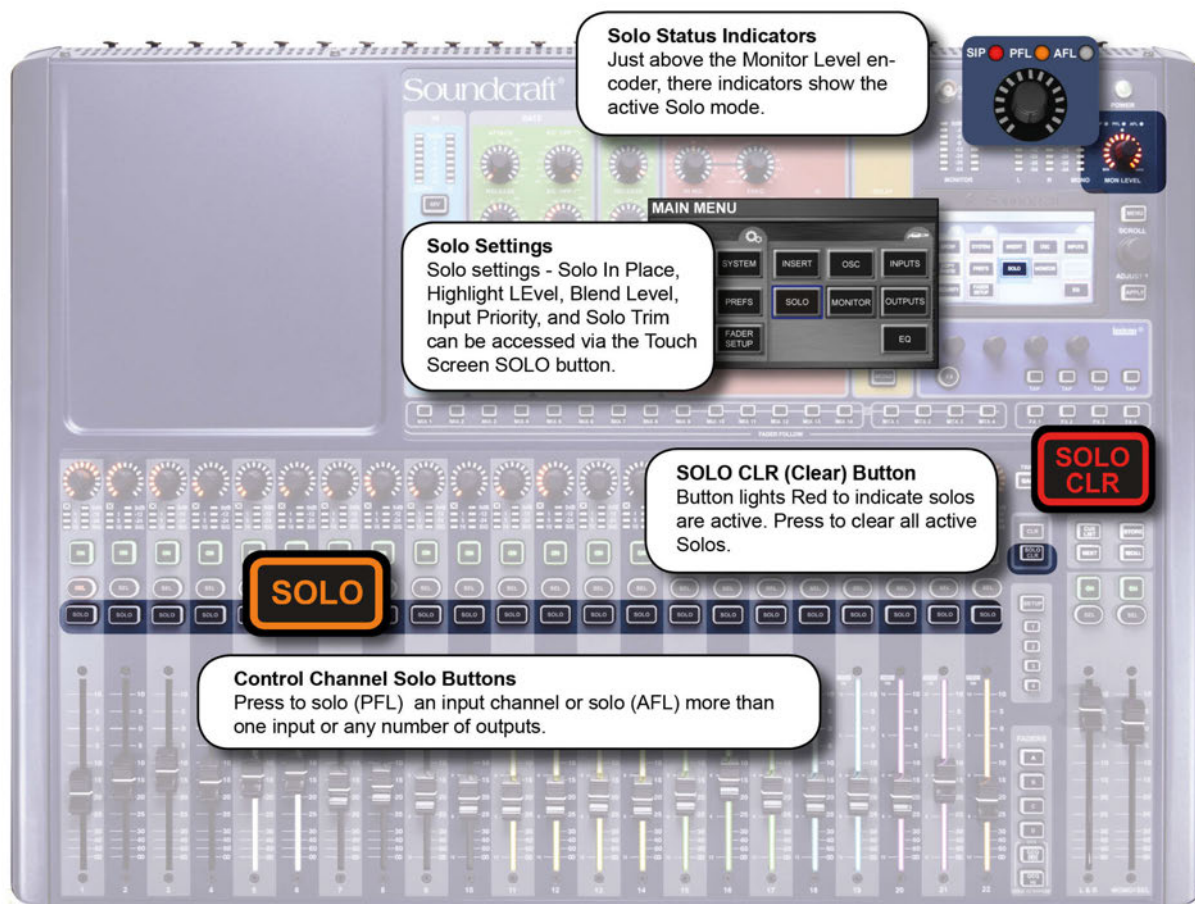

There are two main types of SOLO: PFL (Pre Fade Listen) and AFL (After Fade Listen). The difference between the two is the 'tap' where the solo source is taken from in the selected channel - pre- or post-fader.

The console has an 'AUTO' Input Solo mode that uses intelligent automatic soloing to provide the best source for any given task or SOLO key operation. If only a single input channel is soloed then PFL routing will be used. If two or more input channels or any output channel are soloed then AFL routing will be used. You can also set the Input Solo Mode as PFL only, or AFL only.

Highlight and Blend settings in the Solo Settings menu allow control 'background' levels. 'Highlight' allows a soloed channel to stand out by attenuating other soloed channels by the required amount. It is activated by pressing and holding a Solo button. 'Blend' sets an attenuation level for the whole monitor source so you can dial in a certain amount of background with any soloed channels.

Solo In Place (SIP) is a Solo mode that routes the soloed signal to the main mix outputs. This can be useful, for example, during sound check where you want to quickly select specific sources for checking. The Solo In Place mode is activated via the Solo Settings Menu (Touch Screen) to prevent accidental activation during performance.

WARNING: Solo In Place Mode will interrupt the Main Mix outputs. Do not activate during performance.

MIX FEATURES > SOLO SYSTEM



SOLO

Press to solo the assigned channel

Normal button behaviour is 'latching' (press on - press off). Press and hold a SOLO button for momentary (non-latching) behaviour. Press and hold an active SOLO button to use the Highlight feature, which highlights a soloed channel by attenuating other soloed channels. SOLO buttons light up orange when active.



SOLO CLR

Press to clear any active solos.

Button lights up Red to show there are active solos.



Solo Status Indicators

Indicators light to show Solo mode / status.

If only a single input channel is soloed then PFL routing will be used. If two or more input channels or any output channel are soloed then AFL routing will be used.



SOLO (Touch Screen)

Access Solo settings menu.



Solo In Place

Switch Solo In Place (SIP) mode On or Off.

Solo In Place routes soloed signals to the main mix outputs rather than the monitor outputs, so it should not be activated during performance. An SIP logo is shown at the top of the Touch Screen when active.



Highlight Level

The attenuation level of the unhighlighted soloed channels while Highlight is active.

With more than one active Solo, press and hold an active SOLO button to use the Highlight feature.

MIX FEATURES > SOLO SYSTEM



Blend Level

The attenuation level of the primary monitor source while a PFL or AFL is active.

The default setting is $-\infty$ (- infinity) resulting in complete mute of the normal monitor source.



Input Priority

Allow input Solos to temporarily override an output AFL.

When active, this allows convenient monitor and control of contributions to a mix. If all active solos are cleared the system reverts to monitoring the active output AFL solos.



Solo Trim

± 10 dB of trim to the level of the Solo bus to the monitor system.

This control is independent of the main monitor level control.



Input Solo Mode

Set the Input Solo Mode to Auto, AFL, or PFL.

In Auto Mode the console chooses Pre-fade Listen solo (PFL) when only one Input Channel is soloed, or After-Fader Listen (AFL) when more than one Input Channel is soloed. In AFL or PFL mode, only those solo types are used.

The PFL bus takes its feed from a DSP channel before the Fader and Mute button; the AFL bus takes its feed from a DSP channel after the Fader and Panning stages.



Select Follows Solo

Enable or Disable 'Select Follows Solo' Mode.

When enabled, pressing a Solo button will also select that DSP channel, as if you had pressed the SEL button. It will, for example, assign the ACS to that channel's audio parameters. It will always choose the last DSP Channel soloed.

MIX FEATURES > MONITORING

The Si Expression monitoring system is comprehensive, yet simple. The monitoring source (active monitor signal) will normally be the main LR mix, though will switch to any selection made in the Solo system - AFL or PFL busses.

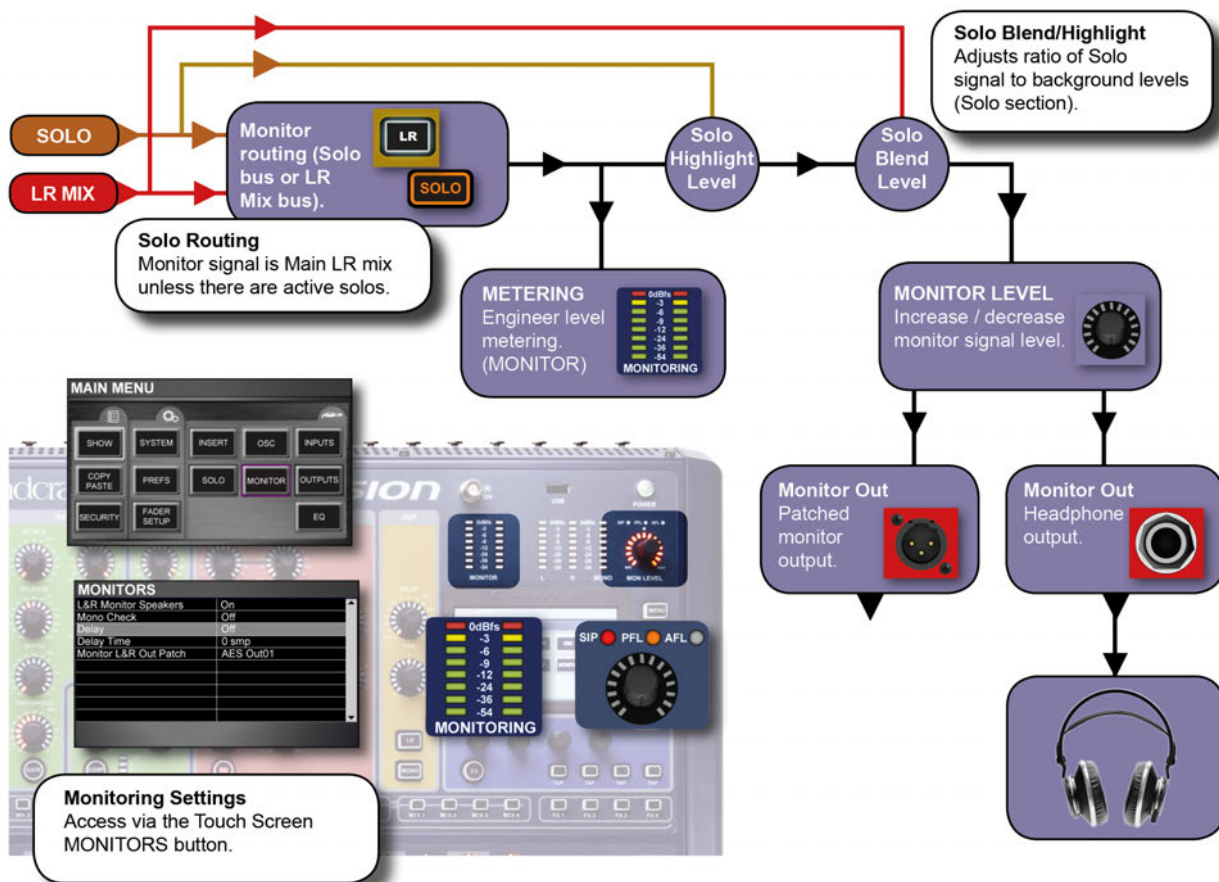

The active monitor signal is always available on the headphones output (located below the front of the console near fader 1) with level controlled by the MON LEVEL encoder. There is also a parallel Monitor Output Patch available allowing the engineer to connect control room speakers or headphone distribution, for example.



MON LEVEL

Adjust the overall monitoring signal level.



MONITORS

Indicates level in the engineer's monitor system

This is normally the LR signal but may be PFL/AFL, or other signal as set in the MONITOR system menus. The scale is dBfs (full scale, digital), so the 0dB level is at clipping.



MIX FEATURES > MONITORING

MONITORS	
L&R Monitor Speakers	On
Mono Check	Off
Delay	Off
Delay Time	0 smp
Monitor L&R Out Patch	AES Out01

Monitoring Settings Menu

You access the Monitor Settings menu by touching the MONITOR Touch Screen button from the Main Menu.



L&R Monitor Speaker

Enable / disable the Monitor Output patch.

Patching for the monitor output is specified in the separate Monitor L&R OutPatch menu item below.



Mono Check

Outputs a mono sum of the stereo monitor signal.

This adds left and right monitor outputs together. A mono check is important when compatibility with mono playback devices is required - some delays and stereo processing can cause mono issues that will not necessarily be obvious when listening in stereo.



Delay

Enable / disable the monitor output delay.

The monitor output delay can be used to synchronise the monitor output with, for example, the Front Of House output, which can be subject to system and distance delays, making monitoring in the same environment difficult.



Delay Time (samples, milliseconds)

Set the Monitor Output delay time.

At 96 Samples (48kHz sampling rate), the parameter unit changes to milliseconds (ms)



Monitor L&R Out Patch

Set the physical patching for the monitor output signal.

The Monitor Output patch is additional to the headphones output.

MIX FEATURES > CLR & ALT+CLR

The CLR (Clear) button located to the right of the Channel Faders area is used in conjunction with individual input channels, output channels, channel parameters, and mutes to clear or reset to default.

The ALT button (above-right of LRM Mix faders) can be used in conjunction with the CLR button to clear or reset parameters, channels, and bus mixes across the whole of the console.

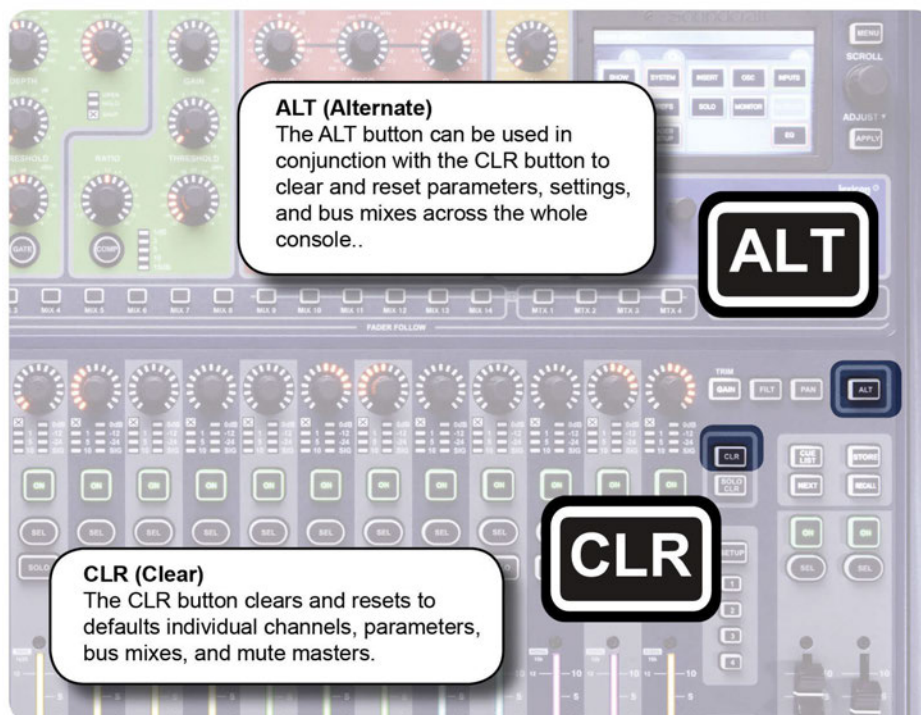

CLR Functions

CLR + SEL button (Channels)

Reset all audio parameters within the channel or bus to the factory defaults (does not affect functions such as SOLO, bus type, names patching and mute assignment, or preamp gain).

CLR + HPF (ACS)

Reset HPF setting for the currently selected channel back to default.

CLR + EQ (ACS)

Reset all EQ section parameters for the currently selected channel.

CLR + GATE (ACS)

Reset all Gate section parameters for the currently selected channel.

CLR + COMP (ACS)

Reset all COMPRESSOR parameters for the currently selected channel.

MIX FEATURES > CLR & ALT+CLR

CLR + GEQ HI/LO (FADERS)

Reset all Graphic EQ levels to 0dB for the currently selected channel. Only works where GEQ is available (output / bus channels).

CLR + tOTEM (FADER FOLLOW) button

Reset all contributions and ON status from channels or buses to the selected bus back to factory defaults.

CLR + Mute Master 1-4

While in MUTE setup mode: Clear channel mute assignments to the selected Mute Master.

ALT + CLR Functions**ALT + CLR + SEL**

Reset all audio parameters in all like-for-like channels across the whole console (does not affect functions such as SOLO, bus type, names patching and mute assignment, or preamp gain).

ALT + CLR + EQ

Clear all EQ section parameters across the whole console (on ALL channels).

ALT + CLR + HPF

Reset all High Pass Filters across the whole console to default.

ALT + CLR + COMP

Clear all Compressor section parameters across the whole console.

ALT + CLR + GATE

Clear all GATE section parameters across the whole console.

ALT + CLR + PHASE

Resets the phase to Off across the whole console.

ALT + CLR + LR

Resets all LR routing to Off across the whole console.

ALT + CLR + MONO

Resets all MONO routing to Off across the whole console.

ALT + CLR + Any MIX tOTEM button (MIX 1-14)

Resets all channels' contributions to all 14 Mix busses to zero. It Does not affect the Auxiliary Mix bus master channels or master levels.

MIX FEATURES > CLR & ALT+CLR

ALT + CLR + Any FX tOTEM button (FX 1-14)

Resets all channels' contributions to all four Lexicon FX Send busses to zero. It Does not affect the FX Send bus master channels or master levels.

ALT + CLR + Any MTX tOTEM button (MTX 1-14)

Resets all channels' contributions to all four Matrix busses to zero. It Does not affect the Matrix bus master channels or master levels.

ALT + CLR + Mute Master 1-4

While in MUTE setup mode: Clear all channel mute assignments to the Mute Masters.

Other ALT Button Functions

Though not related to the CLR (Clear) function, the following ALT functions are included for completeness, though they are also included in the relevant sections of this manual.

ALT + ON

Sets the selected mix send (fader) to unity.

ALT + NEXT

Scrolls and activates the previous cue in the cue list.

SHOWS, CUELIST, AND SNAPSHOTS

The console file system uses the Show as it's basic file. The Show contains all console settings, plus the Cuelist. The Cuelist contains recallable Cues that contain Snapshots of console settings, plus automation functionality - MIDI and HiQnet functionality.

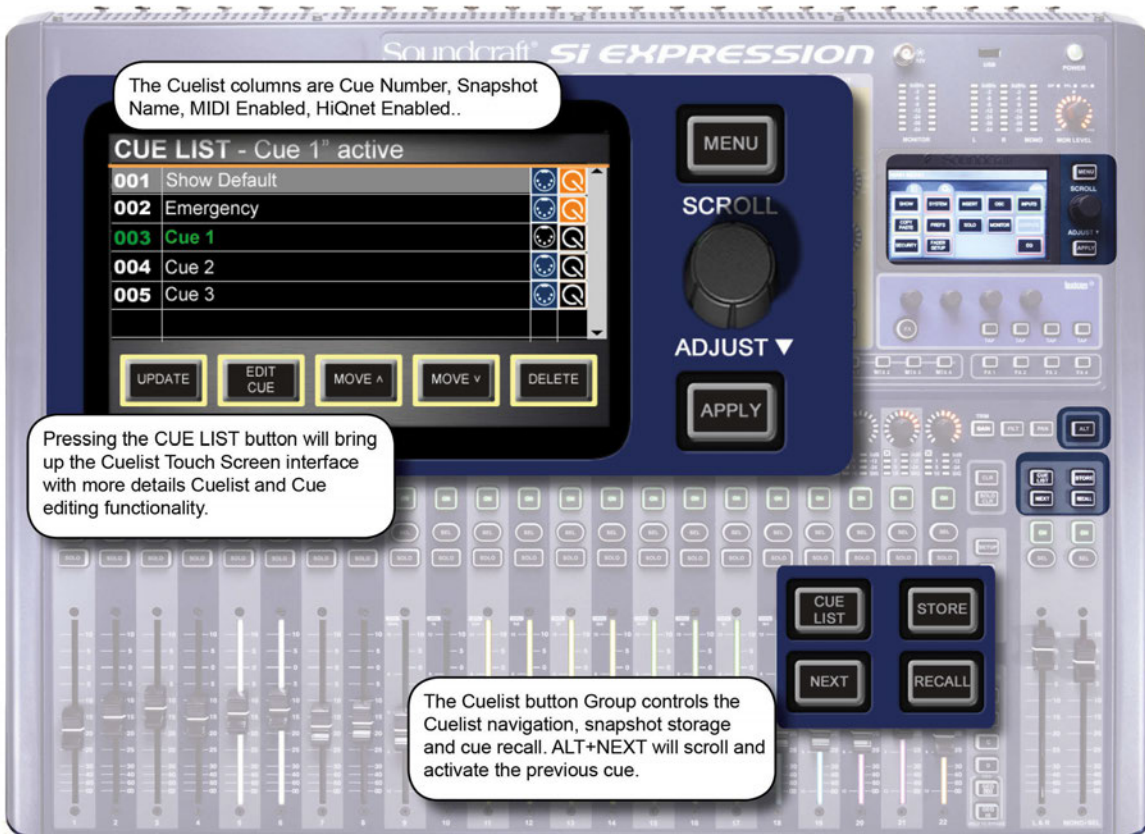
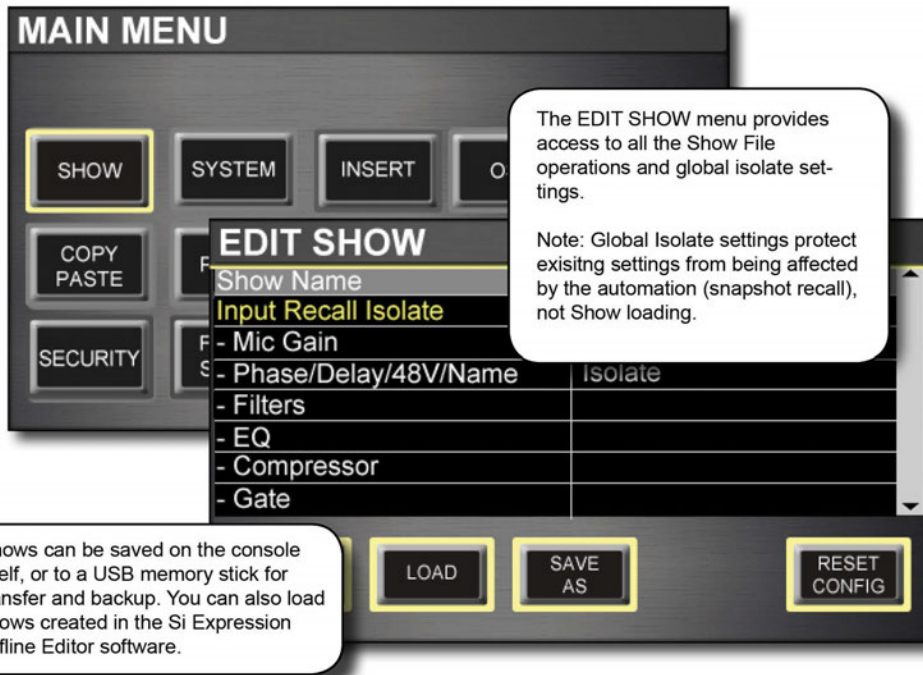

SHOWS, CUELIST, SNAPSHOTS > SHOWS

A Show is an entire console setup including Cuelist and associated Snapshots. Shows can be saved, loaded, and created in the EDIT SHOW Touch Screen Menu. You can also reset the I/O configuration of the console through the EDIT SHOW Touch Screen Menu. The console's USB port allows external storage of Shows, as well as transfer between systems and the Si Expression Offline Editor software.

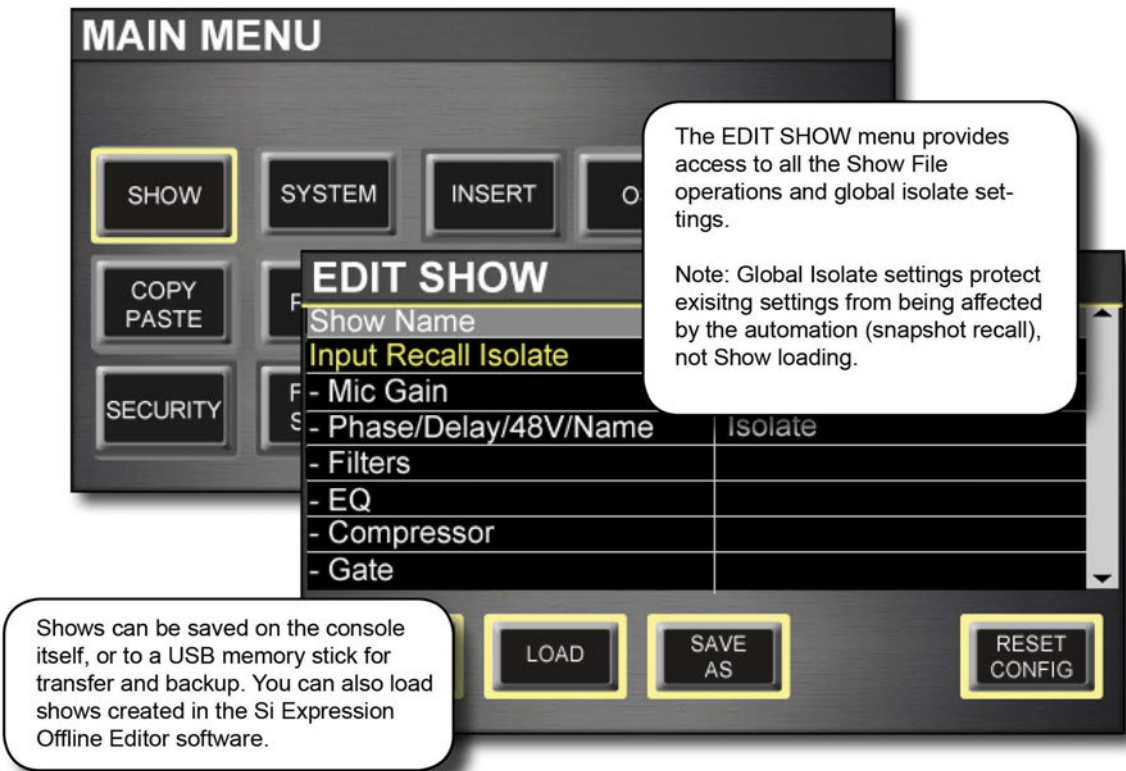

The EDIT SHOW menu also provides access to the Global Isolate filter settings. The Isolate system allows you to isolate parameters from console automation (snapshot recall rather than Show loading).



NEW SHOW

Create a new Show.



A new show deletes all cues and their associated events but retains names, audio settings, patches, and similar since there is a high probability these will be re-used in the 'new show'. The system will provide a warning the action will overwrite the current show and allows the action to be aborted.



DELETE

Initiates the deletion of a Show File or Folder.

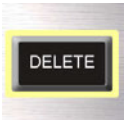

This button brings up the file navigation screen so you can navigate to the file or folder you wish to delete. Pressing the APPLY button will confirm the deletion. The system will require an additional confirmation of the action before any delete action is invoked and allows the action to be aborted. It is not possible to delete a folder containing files.

SHOWS, CUELIST, SNAPSHOTS > SHOWS



LOAD

Initiate the Load Show process.

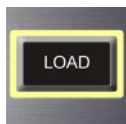

You can navigate the internal file system (MMC) or USB key (if present) and select a Show File to load by pressing the APPLY button. The system will provide a warning that the action will overwrite the current show and allows the action to be aborted.



SAVE AS

Initiate the process of saving the current show.



When you press SAVE, the QWERTY keyboard is shown with the current show name. You can continue the save action with the current name (and overwrite) or change the name to create a new show file. Press APPLY to confirm the name and navigate the file system to confirm the save location.



RESET CONFIG

Re-establish the system configuration.



Clears the console database of any option cards or external I/O systems that may have been attached to the console then forces a 're-discovery' of any installed option cards or connected I/O system, such as a Soundcraft Stagebox. The system will provide a warning that the action will overwrite the current configuration database and allow the action to be aborted.



Show Name

Edit the name of the current Show..



Touching the value field will bring up a QWERTY keyboard screen where you can edit the Show Name.



Global Isolate Filters

Select and Isolate parameters from recall by the automation system.



If a parameter or group of parameters are set to 'Isolate', they will not be changed from the current setting when a new snapshot is recalled, even if the snapshot has a different setting. Isolate settings for individual channels are available via the INPUTS and OUTPUTS menus. NOTE: All parameters are saved with a snapshot, regardless of the any Isolate settings.

SHOWS, CUELIST > CUELIST

The Si Expression incorporates a comprehensive Cuelist and snapshot automation system for fast access to preset console states and for working with other performance systems via MIDI and Harman's HiQnet.

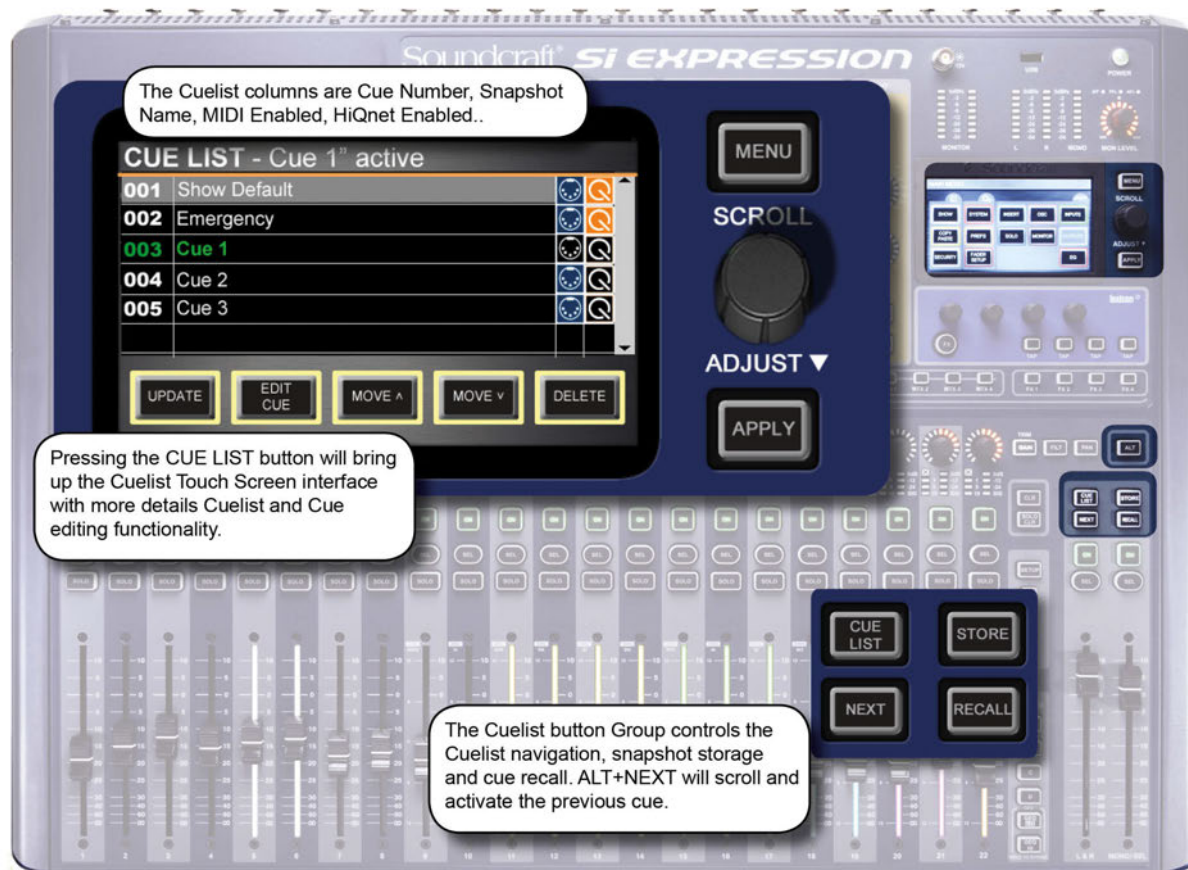

A snapshot is a 'picture' of the entire console state - all settings, patching, routing, and so on. A cue is essentially a snapshot of the console's state, plus automation parameters: MIDI Transmit (a MIDI message sent when a cue is recalled), MIDI Receive (a MIDI message that will recall a the snapshot), and HiQnet Transmit (send a HiQnet venue preset event).

When you store a cue, you also take a snapshot to be stored with that cue. The console's Cuelist is a list of cues that can be recalled when required. The Cuelist is stored within a Show (see 9.1).

The primary snapshot/cue controls are the Cuelist button group: CUE LIST, STORE, NEXT, and RECALL. These are located just above the main Left/Right and Mono Master Control Channels. The CUE LIST button gives access to the detailed Cuelist editing and functionality on the Touch Screen.

Please Note: Isolate filters (isolating parameters and channels from automation / Cue recall) are set elsewhere. The Global Isolates are available in the SHOW menu, and channel isolates are set in the INPUTS / OUTPUTS menus.

SHOWS, CUELIST > CUELIST



CUE LIST

Bring up the Cuelist screen in the console Touch Screen.



This gives access to Cuelist editorial, and Cue editing functionality. There are four columns in the main Cuelist: Cue Number, Snapshot Name, MIDI Status, and HiQnet Status. Cues are colour-coded according to: Green text: Currently loaded / Current Cue; White text: NEXT Cue (will be loaded with NEXT button); Grey Text: Inactive Cue; Grey Highlight/Cursor: RECALL Cue (will be loaded with the RECALL button or by pressing the Touch Screen Encoder).



STORE

Store the current snapshot in the Cuelist.



The Snapshot will be added to the end of the Cuelist and named automatically "Unnamed Snapshot n" where 'n' is the snapshot's numbered position in the Cuelist. Remember that the number in the snapshot name and the order of snapshots can change, so the number in the snapshot name and the Cue number will not necessarily correlate after re-ordering and re-naming.



RECALL

Load the currently highlighted Cue

Pressing the Touch Screen Encoder will also load the currently highlighted Cue.



NEXT

Load the Next Cue.

The Next Cue will be shown in white text in the Cuelist.



ALT + NEXT

Load the previous Cue.

The previous cue will be the one numerically previous to the currently selected one. That is, if Cue Number 5 is active, the 'previous' Cue will be Cue Number 4 - not the previously loaded Cue, if that is different.



SHOWS, CUELIST > CUELIST & SNAPSHOTS



UPDATE

Update the currently active Cue with the current Snapshot.

Useful for editing Cues as they are used. When you press UPDATE confirmation will be required in the Touch Screen as the action will overwrite the current Cue.



EDIT CUE

Edit the Cue details in the Touch Screen.

Includes Snapshot Name, plus MIDI and HiQnet transmit and receive settings.



MOVE UP

Move the currently highlighted Cue up one in the Cue List.

This action affects the currently highlighted Cue, which is not necessarily the currently active Cue. 'Up' means 'to the next lower numbered Cue Number'.



MOVE DOWN

Move the currently highlighted Cue down one in the Cue List.

This action affects the currently highlighted Cue, which is not necessarily the currently active Cue. 'Down' means 'to the next higher numbered Cue Number'.

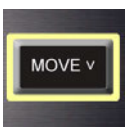

DELETE

Delete the currently highlighted Cue.

This action affects the currently highlighted Cue, which is not necessarily the currently active Cue. Confirmation will be required in the Touch Screen.

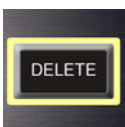

SHOWS, CUELIST > CUELIST & SNAPSHOTS



MIDI Status

Highlighted blue if there is an active MIDI receive or transmit setting in the Cue.



HiQnet Status

Highlighted orange if there is an active HiQnet transmit active in the Cue.



SHOWS, CUELIST > CUELIST > EDIT CUE

By touching the EDIT CUE Touch Screen button in the Cue List display you access more detail, including the Cue Name, and MIDI/HiQnet automation parameters. MIDI program change messages can be used to recall Cues, and/or Cues can transmit MIDI program changes when they are recalled. HiQnet is a network protocol, developed by Harman Pro for communications and control between audio system components. The console can send HiQnet venue presets when Cues are recalled.

EDIT CUE	
Cue Name	Snapshot 1
MIDI Transmit	
- Program Change	Off
- Program Number	1
- Channel	1
MIDI Receive	
- Program Change	Off
- Program Number	1
- Channel	1
HiQnet Transmit	



Cue Name

Edit the name of the current Snapshot / Cue.

Brings up the Touch Screen QWERTY keyboard for entering / editing the Cue Name.



MIDI Transmit

Set the console to send MIDI program change messages when the Cue is recalled.

SHOWS, CUELIST > CUELIST > EDIT CUE



MIDI Receive

Set the Cue to recall when the console receives a particular program change message.

In the event two or more cues are set to receive the same program change on the same MIDI channel the console shall play the first cue in the CUE LIST that satisfies the condition.



MIDI Program Change

Turn the program change function On or Off.

The Snapshot will be added to the end of the Cuelist and named automatically "Unnamed Snapshot n" where 'n' is the snapshot's numbered position



MIDI Program Number

Choose a MIDI Program Change number.



MIDI Channel

Choose a MIDI channel for the specified Program Change number.

MIDI Receive settings can specify Omni (all MIDI channels) as an option here.



HiQnet Transmit

Set the console to send a HiQnet Venue preset when the Cue is recalled.

Console network settings, including IP settings and HiQnet Enable and Address options can be found in the Touch Screen SYSTEM menu - reference chapter 11.



HiQnet Venue Recall

Set Venue Recall On or Off for the Cue.



HiQnet Venue Number

Set the transmitted Venue number for this Cue.

LEXICON FX

The console comes with four Lexicon FX processors, each with 29 available algorithms. Each FX unit has its own dedicated FX Send Bus, and stereo return path.

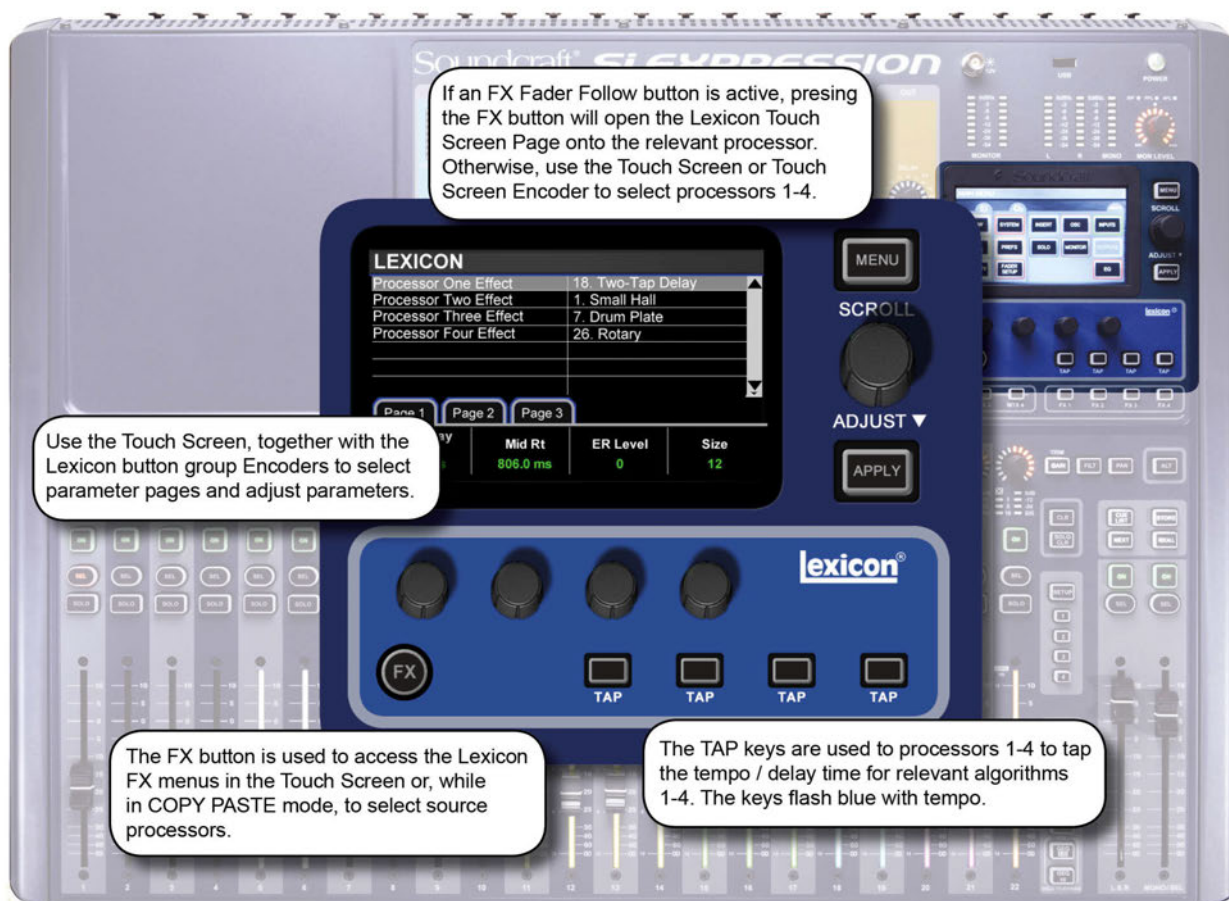

Send Routing

Every input channel can contribute to the FX 1-4 send busses, which correspond to the FX unit 1-4 inputs.

Contributions are controlled in the same way as Mix bus contributions, via the FX 1 - 4 FADER FOLLOW (tOTEM) buttons, which assigns each channel's contribution to the selected bus to its fader. The Stereo Return channel is assigned to the MONO/SEL Control Channel on the right hand end of the console.

Return Routing

The Stereo Input channels, ST 3 - ST 6 are, by default, patched to the Lexicon FX unit 1-4 returns (as per the console's default set-up). For example, Stereo Input ST 3 is patched to LEX-RT1 (FX Processor 1, Lexicon Return Channels 1 and 2); Stereo Input ST 4 is patched to LEX-RT3 (FX Processor 2, Lexicon Return Channels 3 and 4), and so on. Stereo Input channels do not have to be patched to FX returns, but FX unit 1-4 returns can only be patched to Stereo Inputs ST3-6.

Patching for the Stereo Input channels is via the OUTPUTS Touch Screen menu.

LEXICON FX

Storage

All Parameters from the four FX Units and for all FX Types are stored with console Snapshots. See chapter reference 9.2 for more on the Cuelist and Snapshots.

Copy Paste

Settings can be copied and pasted between processors using the console COPY PASTE function. Touch COPY PASTE in the Touch Screen Main Menu, then press the FX button in the Lexicon control group. The Touch Screen will show the four processors - touch one to copy, then press and hold PASTE-HOLD and touch another processor to Paste.



FX

Access FX Screen

Access the Lexicon FX menus in the Touch Screen or, while in COPY PASTE mode, select processors for Copy / Paste function.



ADJUST/SCROLL (Touch Screen Control)

Can be used instead of touch to select an FX processor.

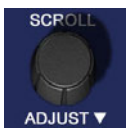

FX Encoders

Adjust the corresponding FX parameters.



TAP

Tap delay/tempo setting.

Used for processors 1-4 to tap the tempo / delay time for relevant algorithms 1-4. The keys light blue when the function is available, and flash in time with the set tempo.

NOTE: The resulting tempo is based on an average interval between all taps, up to five seconds apart. In order to restart the measurement you need to wait five seconds without tapping.



LEXICON FX > REVERBS

Reverberation (or “reverb” for short) is the complex effect created by the way we perceive sound in an enclosed space. When sound waves encounter an object or boundary, they don’t just stop. Some of the sound is absorbed by the object, but most of the sound is reflected or is diffused. In an enclosed space, reverb is dependent on many features of that space, including the size, shape and the type of materials that line the walls. Even with closed eyes, a listener can easily tell the difference between a cupboard, a locker room and a large auditorium. Reverb is a natural component of the acoustic experience, and most people feel that something is missing without it.

Halls

SMALL HALL, LARGE HALL, DRUM HALL, VOCAL HALL

A Hall reverb is designed to emulate the acoustics of a concert hall – a space large enough to contain an orchestra and an audience. Because of the size and characteristics, Halls are the most natural-sounding reverbs, designed to remain “behind” the direct sound – adding ambience and space, but leaving the source unchanged. This effect has a relatively low initial echo density which builds up gradually over time.

Vocal Hall and Drum Hall reverbs are specifically tailored for those uses. Vocal Hall has a lower overall diffusion which works well with program material that has softer initial transients like a voice. Drum Hall has a higher diffusion setting which is necessary to smooth out faster transient signals found in drums and percussion instruments.

In addition to general instrumental and vocal applications, the Hall program is a good choice for giving separate tracks in a mix the sense of belonging to the same performance.

Plate Reverbs

SMALL PLATE, LARGE PLATE, DRUM PLATE, VOCAL PLATE

A Plate reverb is a large, thin sheet of metal suspended upright under tension on springs. Transducers attached to the plate transmit a signal that makes the plate vibrate, causing sounds to appear to be occurring in a large, open space. The Plates in the Vi4 FX units model the sound of metal plates with high initial diffusion and a relatively bright, coloured sound. Plate reverbs are designed to be heard as part of the music, mellowing and thickening the initial sound. Plate reverbs are often used to enhance popular music, particularly percussion.

Chamber Reverb

Historically, recording studio chambers were oddly shaped rooms with a loudspeaker and set of microphones to collect ambience in various parts of the room. Chamber programs produce even, relatively dimensionless reverberation with little colour change as sound decays. The initial diffusion is similar to the Hall programs. However, the sense of size and space is much less obvious. This characteristic, coupled with the low colour of the decay tail, makes these programs useful on a wide range of material - especially the spoken voice, to which Chamber programs add a noticeable increase in loudness with low colour.

LEXICON FX > REVERBS**Room Reverb**

Room produces an excellent simulation of a very small room which is useful for dialogue and speech applications. Room is also practical when used judiciously for fattening up high energy signals like electric guitar amp recordings.

Ambience Reverb

Ambience is used to simulate the effect of a small or medium sized room without noticeable decay. It is often used for voice, guitar or percussion.

Spring Reverb

A Spring reverb is created by a pair of piezoelectric crystals—one acting as a speaker and the other acting as a microphone—connected by a simple set of springs. The characteristic ‘boing’ of a spring is an important component of many classic rock and rockabilly guitar sounds.

Reverse Reverb

Reverse reverb works in the opposite fashion from normal reverb. Whereas a normal reverb has the loudest series of reflections heard first that then become quieter over time, the Reverse reverb has the softest reflections (essentially the tail of the reverb) heard first, and then grows louder over time until they abruptly cut off.

Spring Reverb

A Spring reverb is created by a pair of piezoelectric crystals—one acting as a speaker and the other acting as a microphone—connected by a simple set of springs. The characteristic ‘boing’ of a spring is an important component of many classic rock and rockabilly guitar sounds.

LEXICON FX > REVERBS > REVERB PARAMETERS

**PRE DLY - Pre Delay**

Adjust time delay between the source signal and the onset of reverberation.

This control is not intended to precisely mimic the time delays in natural spaces, as the build-up of reverberation is gradual, and the initial time gap is usually relatively short. For the most natural effect, the Pre Delay values should be set in the range of 10-25 milliseconds. However, if a mix is very busy or overly cluttered, increasing the Pre Delay time may help clarify it, and set each instrument apart from each other.

**Mid RT - Mid Range Reverb Time**

Adjust the amount of time the mid-range reverb can be heard.

Higher settings increase reverberation times which are usually associated with larger acoustical environments, but can decrease intelligibility. Lower settings shorten reverb times and should be used when a smaller apparent space or a more subtle effect is desired.

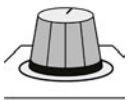
**ER Level - Early Reflections Level**

Adjust the level of early reflections within the reverb.

**ER Time - Early Reflections Time**

Adjust the amount of time before reverb early reflections occur.

**Size**

Build-up rate of diffusion after the initial period (which is controlled by Diffusion).

The Size control changes reverb sound from very large to very small. Generally, set this control to the approximate size of the acoustic space being created, before adjusting anything else. The size in meters is roughly equal to the longest dimension of the space. Audio is temporarily muted when Size is changed.

**RT High Cut**

Rt HC sets the frequency above which a 6dB/octave low-pass filter attenuates the reverberated signal.

It does not attenuate the reflections. High frequencies are often rolled off with this parameter, resulting in more natural-sounding reverberation. Setting a low frequency for this parameter can actually shorten the reverb time, as it damps the audio as it recirculates

LEXICON FX > REVERBS > REVERB PARAMETERS

**Shape**

Adjust the 'contour' of the reverberation envelope.

With Shape all the way down, reverberation builds explosively, and decays quickly. As Shape is advanced, reverberation builds up more slowly and sustains for the time set by Spread. With Shape in the middle, the build-up and sustain of the reverberation envelope emulates a large concert hall (assuming that Spread is at least halfway up, and that Size is 30 meters or larger).

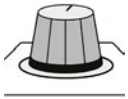
**Spread**

Adjust reverb onset and sustain.

Low Spread settings result in a rapid onset of reverberation at the beginning of the envelope, with little or no sustain. Higher settings spread out both the build-up and sustain.

**Diff - Diffusion**

Initial echo density.

High settings of Diffusion result in high initial echo density, and low settings cause low initial density. In a real-world situation, irregular walls cause high diffusion, while large flat walls cause low diffusion. For drums and percussion, try using higher Diffusion settings.

**Bass Bst - Bass Boost**

Boost or cut frequencies below the Bass Boost Frequency (the transition point from Mid Rt to Low Rt).

The amount of boost or cut required is highly dependent on the material being processed.

**RT Hi Cut - Reverb Time High Cut**

Set the frequency of a 6dB/octave low-pass filter on the reverberated signal.

It does not attenuate the reflections. High frequencies are often rolled off with this parameter, resulting in more natural-sounding reverberation. Setting a low frequency for this parameter can actually shorten the reverb time, as it damps the audio as it recirculates.

**Hi Cut**

Adjust the amount of high frequency content in the reverberation tails.

Higher frequency settings increase high frequency response, creating brighter reverbs; lower frequency settings create darker reverbs with more bass frequency emphasis.

**Hi Cut**

Adjust the amount of high frequency content in the reverberation tails.

Higher frequency settings increase high frequency response, creating brighter reverbs; lower frequency settings create darker reverbs with more bass frequency emphasis.

LEXICON FX > DELAYS

Delays repeat a sound a short time after it first occurs. Delay becomes echo when the output is fed back into the input (feedback). This turns a single repeat into a series of repeats, each a little softer than the last.

Studio Delay

The Studio Delay features up to 1 second of stereo delay and offers a built-in ducker that attenuates the delay output whenever signal is present at the input. This can be used to keep the original signal from being muddled up by delay repeats.

2-Tap Delay

The 2-Tap Delay is probably best described as an adjustable pong delay where each tap can be individually set in relation to the delay time. The 2 taps are a calculated percentage of the actual delay time from 1-100% (for example, if the delay time is 500ms and Tap 1 is set to 50% and Tap 2 is set to 100%, Tap 1 time would be 250ms and Tap 2 time would be 500ms). Narrow spacing of the tap percentages can widen the stereo image of the delay while wider tap spacing can create rhythmic delay lines.

Modulated Delay

The Modulated Delay is enhanced by an LFO (low frequency oscillator) that produces a chorusing effect on the delay repeats. This is a great delay for guitar and instrument passages that need that “special something.”

Mono Delay

The Mono Delay is the cleanest, most accurate of the delay programs, with up to 1 second of mono delay with panned output, and the built-in ducking feature.

Pong Delay

This delay effect pans the delay repeats from left to right, while the input signal remains at its original(centre) position.

Tape Delay

In the days before digital, delays were created using a special tape recorder in which the magnetic recording tape was looped, with closely-spaced recording and playback heads. The delay effect was created by the tape moving in the space between the record and playback heads – while delay time was adjusted by changing the speed of the tape loop. Although very musical-sounding, wow and flutter combined with a significant loss of high frequencies, and to some extent also low frequencies, are all elements commonly associated with tape recordings.

Reverse Delay

This delay effect emulates the old studio trick of flipping a tape over, playing it backwards through a tape delay, and recording the effect. The delays build up from softer to louder – creating the sensation that the delays come before the signal.

LEXICON FX > DELAYS > DELAY PARAMETERS

**Dly Time - Delay Time**

Controls the length of the delay time relative to Tempo.

At the middle of its range, delay repeats are synchronous with the Tempo button; lower values create faster repeats, while higher values increase the time between repeats.

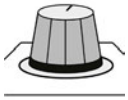
**Feedback**

Controls the number of delay repeats by feeding the delay output signal back into the delay input.

This creates a series of delay repeats, each slightly attenuated until they become inaudible. Higher settings create more repeats; lower settings reduce the number of repeats. When this knob is turned fully clockwise, it engages Repeat Hold – delay repeats play back in an infinite loop, but no further input signal is introduced into the delay effect. Repeat Hold is available only on Studio, Mono and Pong Delay.

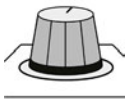
**Hi Pass**

Frequencies below this are filtered / removed.

**Lo Pass**

Frequencies above this are filtered / removed.

**Duck Lvl - Duck Level**

Set the input signal level at which ducking occurs.

Studio, Mono and Pong delays only. Ducking causes delay repeats to be attenuated by a variable amount when an input signal is present. As the performance pauses, the delay signal level returns to its normal setting. This allows the delay to remain as an effect, but not clash with the original signal. For example whilst a vocalist is singing, the level of delay is kept down, but in the pauses the level of the repeats is brought up to provide a smooth tail to the vocal phrases. The Ducker Threshold sets the level at which the input signal has to be at for ducking to cut in – the higher the threshold, the louder the signal has to be for ducking to occur.

**Duck Thr - Duck Threshold**

Ducking attenuation amount.

Ducker Level sets the amount of attenuation once the signal has exceeded the threshold. 0dB is no ducking, 18dB is the maximum amount of ducking to the delayed signal.



Smear

Ducking attenuation amount.

Available only for Tape and Reverse Delays, this parameter controls the amount of “smear,” or signal degradation and frequency loss. The higher the setting, the more each delay repeat loses intelligibility compared to the original signal.

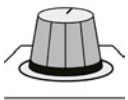

Ratio - Tap Ratio

Controls the Tap ratio of left and right outputs relative to the Delay time.

Specific to the Pong Delay effect, this controls the delay time offset between left and right taps, expressed as a ratio of left to right time difference. In the centre the taps have the same time (1:1).



Swap - Tap Swap

Swaps the delay time tap offset set by the Tap Ratio.

Specific to the Pong Delay effect - reverses the offset set by the Tap Ratio control.



Depth - Modulation Depth

Control the intensity of modulation, or “depth” in the Modulated Delay.

Lower settings produce a more subtle chorus effect, while higher values give a more lush chorusing of the delay repeats.



Pan - Tap Pan

Adjust the pan positions in the stereo field of Tap 1 and Tap 2.



Mix

Ratio of Wet to Dry signal.

100% is fully wet (effect) signal; 0% is fully dry (original) signal.

LEXICON FX > MISC FX

The MISC category provides primarily modulated and pitch-varying effects.

Chorus

Chorus creates a lush, full sound by combining two or more signals together where one is unaffected and the other signals vary in pitch very slightly over time. Chorus is commonly used to fatten up tracks and to add body to guitars without colouring the original tone. Chorus can also be used with discretion to thicken a vocal track.

Flanger

This effect was originally created by simultaneously recording and playing back two identical programs on two tape recorders, then using hand pressure against the flange of the tape reels to slow down first one machine, then the other.

Phaser

The Phaser automatically moves frequency notches up and down the spectrum of the signal by means of a low frequency oscillator (LFO), creating an oscillating “comb filter” type effect. This effect is very useful on keyboards (especially pad presets) and guitars.

Tremolo

Tremolo/Pan creates rhythmic changes in signal amplitude. Tremolo is obtained by setting Phase to 0 degrees, and affects both channels' amplitude simultaneously. If the Phase is set to 180 degrees, an AutoPanner effect is generated, with the amplitude of one channel being raised whilst that of the other channel is lowered.

Vibrato

Vibrato is obtained by smoothly varying the pitch of the signal just sharp and flat of the original at a determined rate. Phase controls whether the pitch of both channels is modulated together, or in an opposite direction.

Rotary

Rotary speaker cabinets were designed to provide a majestic vibrato/choir effect for electronic theatre and church organs. The most well known rotary speaker is the Leslie™ Model 122, which has two counter-rotating elements: a high-frequency horn and a low-frequency rotor with slow and fast speeds.

Pitch Shift

This effect shifts the frequency spectrum of the input signal. Altering the pitch of a sound produces a wide range effects - from subtle detunes to full interval shifts up or down a two octave range. The Pitch Shift effect is a chromatic shifter, meaning all notes of the scale are shifted by the same interval. Pitch Shift is very useful with guitar tracks, monophonic synth lines, or where special vocal effects are needed.

Detune

Detune adds a slightly pitch-shifted version of the original source, thickening the sound. This creates a particularly effective simulation of “double-tracking.” Also a great alternative to the Chorus effect, adding the richness of a chorus without the audible sweep caused by the chorus rate.



Speed

Sets the speed at which the modulated effect cycles.



Depth - LFO Depth

Scales the intensity of the effect.

This control affects the output of the LFO only. It has no effect on the outputs of the individual waveforms.

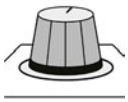

Voices - Number Of Voices

Controls the number of additional Chorus voices.

Higher amounts add more richness to the Chorus effect.

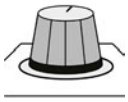

Regeneration

Controls the amount of modulated signal being fed back into the input, creating feedback.

Higher amounts add more resonance to the signal.



Diff - Diffusion

Creates a time-smoothing effect similar to diffusion in reverb.

Diffusion can be a subtle effect to add a little warmth to the chorus.



Pre Dly - Pre Delay

Determines the amount of offset between the two signals that create the flange effect.

Lower values create a tighter effect, higher values result in a more extreme “whooshing” sound.

LEXICON FX > DELAYS > DELAY PARAMETERS

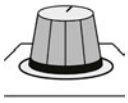

Waveform

Selects the wave pattern used by the modulated effect.

Select from sine wave, triangle wave, Stepped Triangle, and random.



Phase

Controls whether amplitude or depth change occurs in both left and right outputs simultaneously or alternates between left and right outputs.

This control affects the output of the LFO only. It has no effect on the outputs of the individual waveforms.

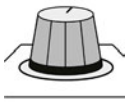

Phs Stgs - Phase Stages

Selects between a 4-, 8-, or 12-state phase shifter.



Spread - Stereo Spread

Increases or decreases the stereo imaging of the Rotary effect.



Drive - Overdrive Gain

Adjust overdrive gain to the preamp section of the rotary speaker effect.

Diffusion can be a subtle effect to add a little warmth to the chorus.



Rot Min

Sets the minimum speed at which the LF Speaker will rotate.

Rotary effect only: The speed limits are used when the speed parameter is changed from Slow to Fast.

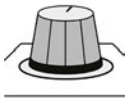

Rot Max

Sets the maximum speed at which the LF Speaker will rotate.

Rotary effect only: The speed limits are used when the speed parameter is changed from Slow to Fast.



Horn Min

Rotary effect only: Minimum speed of the HF rotary horn.

The speed limits are used when the speed parameter is changed from Slow to Fast.



Horn Max

Rotary effect only: Maximum speed of the HF rotary horn.

The speed limits are used when the speed parameter is changed from Slow to Fast.



Doppler

Increases or decreases the Doppler pitch effect.

The Doppler effect is a rise and fall in pitch experienced by an observer when a sound source is moving towards or away from them, due to a compressed or expanded wavefront.

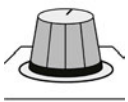

Shift 'n'

Determines the amount of pitch shift or detune shift from the original signal source.

Diffusion can be a subtle effect to add a little warmth to the chorus.



Delay 'n' - Shift Delay

Sets the delay time before the pitch shift or detune effect is heard in the Pitch Shift and Detune effects.

Rotary effect only: The speed limits are used when the speed parameter is changed from Slow to Fast.



Fdbk 'n' - Feedback

Adjusts how much of the shifted signal is sent back through the delay line in Pitch Shift and De-tune.

For creating cascading arpeggio-type effects.



Pan 'n'

Sets the pan position in the stereo field for each tap in the 2-Tap Delay or each channel of the pitch shift/detune effects.

Allows the stereo width to be increased by panning versions of the original signal that have been shifted slightly up and down, to left and right channels respectively.



Mix

Ratio of Wet to Dry signal.

100% is fully wet (effect) signal; 0% is fully dry (original) signal.

SYSTEM SETTINGS

System Settings are accessed via the Touch Screen Main Menu and appear under the Menus PREFERENCES, SYSTEM, and SECURITY.



11.1: Preferences (PREFS)

The PREFS Menu is mainly concerned with LED and LCD (display, buttons etc) brightness and adjustments. However, this is also where you enable or disable the D.O.G.S. (Direct Output Gain Stabiliser) mode so gain changes at mix pre-amps don't affect the Direct Outputs levels.

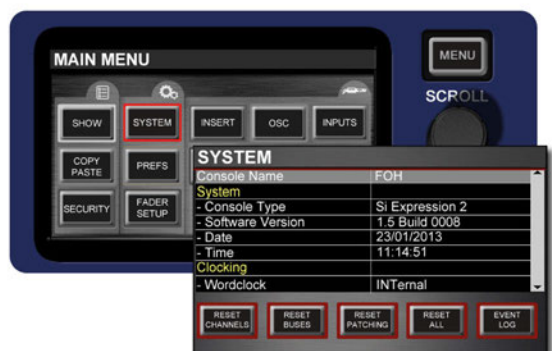

11.2: SYSTEM

The System menu provides information about the console itself, as well as offering settings for the console name, date, time, wordclock, and network settings (for HiQnet and Soundweb functionality). The System Menu also provides reset functions for channels, busses, patching, and 'all', as well as the Event Log.



11.3: SECURITY

This console can be set to allow specific access privileges to a number of users. You can lock-out a variety of console functions, as defined in User Profiles. When LOCK is set in the Security menu, a user selection and valid password are required to operate the console.

SYSTEM SETTINGS > PREFERENCES

Preferences include console brightness settings and the D.O.G.S. (Direct Out Gain Stabiliser) system enable.



LED Brightness

Adjust the brightness of LEDs across the console.

This includes all Encoder level indicators, metering, and status LEDs.



FaderGlow Brightness

Adjust the FaderGlow brightness across the console.

This includes all colour fader lighting.



Screen Brightness

Adjust the Touch Screen brightness.



D.O.G.S.

Enable / Disable Direct Out Gain Stabiliser system.

D.O.G.S. is a tool that prevents Direct Output levels from changing when a Mic Gain is changed - so any feeds taken from the console remain stable. That is, it maintains stored gain structure between channel input and direct output when multiple devices are sharing a single source.

When enabled, D.O.G.S. adjusts the direct output level from each channel inversely to any manual change of a mic gain control (across a change of +16/-10dB) on that channel.

SYSTEM SETTINGS > SYSTEM MENU

The System menu provides information about the console itself, as well as offering settings for the console name, date, time, wordclock, and network settings (for HiQnet and Soundweb functionality). The System Menu also provides reset functions for channels, busses, patching, and 'all', as well as the Event Log.

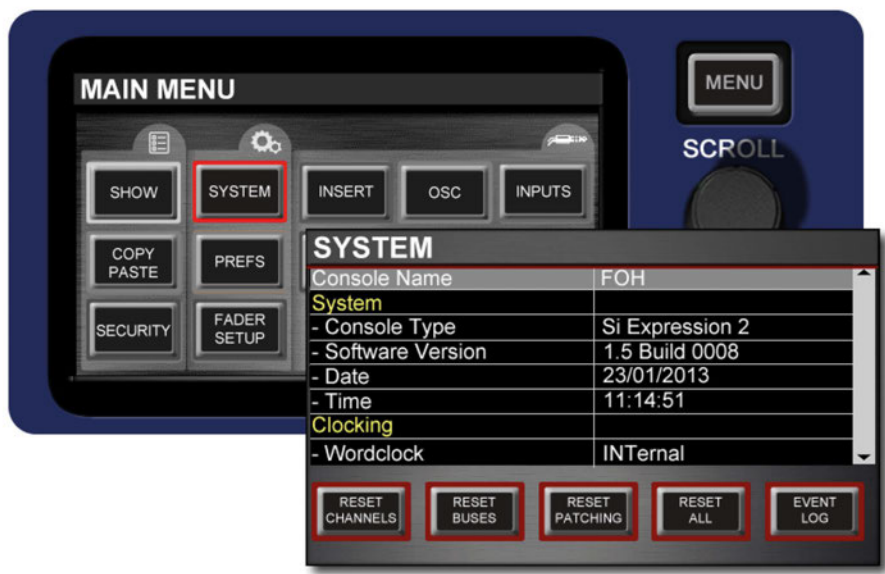

RESET CHANNELS

Reset all Input audio channels to factory default.

Includes all Input Channel audio parameters, channel name and channel type(Mono/Linked). It does not include patching. You will be asked to confirm this action in the Touch Screen.

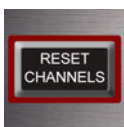

RESET BUSES

Reset all Output audio channels (Bus Masters) to factory default.

Includes all Bus Master audio parameters, bus name and bus type(Mono/Stereo). It does not include patching. You will be asked to confirm this action in the Touch Screen.



RESET PATCHING

Reset all system patching to factory default.

You will be asked to confirm this action in the Touch Screen.



SYSTEM SETTINGS > SYSTEM MENU



RESET ALL

Reset all parameters including names and patches to factory default.

You will be asked to confirm this action in the Touch Screen.



EVENT LOG

A log of specific system events.

Can be useful for trouble shooting and for technical support staff.



Console Name

Name the console

Touch / select the value field to bring up a QWERTY keyboard to edit the Name.



Console Type

Console Model - Read Only



Software Version

Current software version - Read only.



Date

System Date.

Touch or select to bring up a date editor in the Touch Screen.

SYSTEM SETTINGS > SYSTEM MENU

**Time**

System Time.

Touch or select to bring up a time editor in the Touch Screen.

**Wordclock**

Choose an Internal, External, or Option card wordclock reference.

The console can be set as Word Clock Slave (EXternal or OPTION) or Master (INTernal). When set to EXternal the console will attempt to clock from an incoming word clock to the rear panel Word Clock connection. If successful, a CLOCK icon displayed on the title bar. If there is no valid signal the icon is shown with an exclamation mark and the console will run from its internal clock until external clock returns. When set to OPTION, the console will use an installed option card as its reference. The Si EXPRESSION has a single word clock connector, which operates as an output when set to INTernal and as an input when set to EXternal.

**MAC Address**

The Media Access Control address. Read Only.

**IP Address Resolution**

Set IP resolution to DHCP (Dynamic) or Manual.

When you set the IP resolution to manual, you will have to enter a valid IP address in the IP Address field.

**IP Address**

The IP Address of this console on the network.

If IP Resolution is set to DHCP (Dynamic) then this value is read-only. Up to software version 1.6 the console is limited to IPv4 Private Network address ranges: 10.0.0.0-10.255.255.255, 172.16.0.0-172.31.255.255, or 192.168.0.0-192.168.255.255. IP address changes require a console reboot to take effect.

**Subnet Mask**

Used to specify the subnet for this device.

If IP Resolution is set to DHCP (Dynamic) then this value is read-only.

SYSTEM SETTINGS > SYSTEM MENU



HiQnet Enabled/Disabled

Turn HIQnet capability On or Off.

This console can transmit HiQnet Venue Events on the network along with cue recalls. Please see chapter reference 9.2 for more detail. The console can also control Soundweb London Device Pre amp devices directly via HiQnet - see chapter reference 5.1.1 for more detail.



HiQnet Address

The HiQnet address of this device.

SYSTEM SETTINGS > SECURITY MENU

This console can be set to allow specific access privileges to a number of users. You can lock-out a variety of console functions, as defined in User Profiles. When LOCK is set in the Security menu, a user selection and valid password are required to operate the console.



Access privileges are defined in the PROFILES menu. Each user is assigned a Profile when they are created. Editing of users and profiles is only available when logged-on as the administrator.

Please note: Passwords cannot be easily recovered if lost or forgotten. The factory default Administrator user has a password of “password” (lower case”).



ADD USER

Add a User to the Administrator list.

A 'User' is a person / administrator account (a 'profile' is a set of access privileges assigned to a User). When selected, the Touch Screen will display the Add User menu. See chapter reference 11.3.1 for more detail.



EDIT USER

Edit the selected User.

When selected, the Touch Screen will display the Edit User menu. See chapter reference 11.3.1 for more detail.



SYSTEM SETTINGS > SECURITY MENU



DELETE USER

Delete the selected User.

The system will ask for confirmation in the Touch Screen to confirm this action.



PROFILES

Access the Profiles Menu.

Use the Profiles Menu to add and edit profiles that can be assigned to users. A 'profile' is a set of access privileges assigned to a User (a 'User' is a person / administrator account).



LOCK

Lock the console.

After locking, the console will require a User selection and associated password for operation. NOTE: Passwords cannot be easily recovered if lost or forgotten.

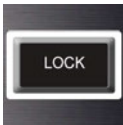

User Select

Select A User from the current list.

You can or select a User to log-in as that user. The Touch Screen will display a User / Password entry screen for that purpose.

SYSTEM SETTINGS > SECURITY > ADD / EDIT USER

The Add and Edit User menus require similar information - User Name, Profile, and Password. Profiles can be created and/or edited in the Edit Profile menu (see chapter reference 11.3.2 for more detail).

SECURITY EDIT USER	
EDIT USER	
User Name	Administrator
Profile	Adminstrator
Password	PASSWORD
<input type="button" value="CANCEL"/> <input type="button" value="SAVE"/>	



User Name

Name the User.

Touching or selecting the value field brings up a QWERTY keyboard in the Touch Screen.



Profile

Profile Name.

Select from the current range of access Profiles.



Password

Choose a password for this user.

Touching or selecting the value field brings up a QWERTY keyboard in the Touch Screen.

SYSTEM SETTINGS > SECURITY > ADD / EDIT USER



CANCEL

Cancel the current User creation or edit without saving any altered values.



SAVE

Save the current User.



SYSTEM SETTINGS > SECURITY > PROFILES

A profile defines the access privileges of a console User. Many functional aspects of the console can be denied to users, according to the Profile. The access categories are: Input Processing, Bus Sends, Bus Processing, Matrix Sends, Matrix Processing, Main Output Processing, Main Output Matrix Sends, Main Output On Faders, GEQ, Fader Layer A, Fader Layer B, Fader Layer C, Fader Layer D, FX, Touch Screen, and Cue List.

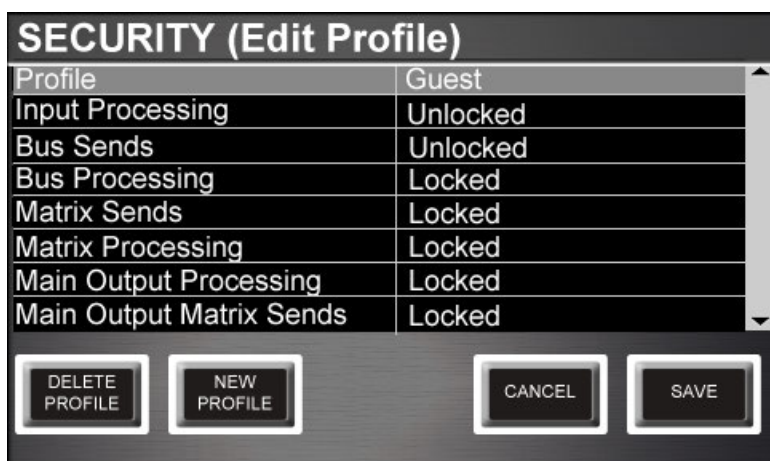

NOTE: If a Cue recall will change an aspect of console functionality that is locked, but Cue List functionality is not locked, the Cue will still be recalled as normal.



DELETE PROFILE

Delete the currently selected Profile.

The system will ask for confirmation in the Touch Screen.

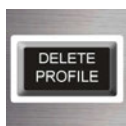

NEW PROFILE

Create a new access Profile.

Touching this option will bring up a QWERTY keyboard in the Touch Screen to name the new Profile. When you press the APPLY button, the screen will change to the Profile options menu.

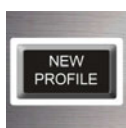

SYSTEM SETTINGS > SECURITY > PROFILES



CANCEL

Cancel the current Profile creation or edit without saving any altered values.



SAVE

Save the current Profile.



Profile

Select a profile to view or edit.

Touch or select the value field to select a Profile. You can only edit profiles when logged on as the Administrator.

SYSTEM SETTINGS > SOFTWARE UPDATE

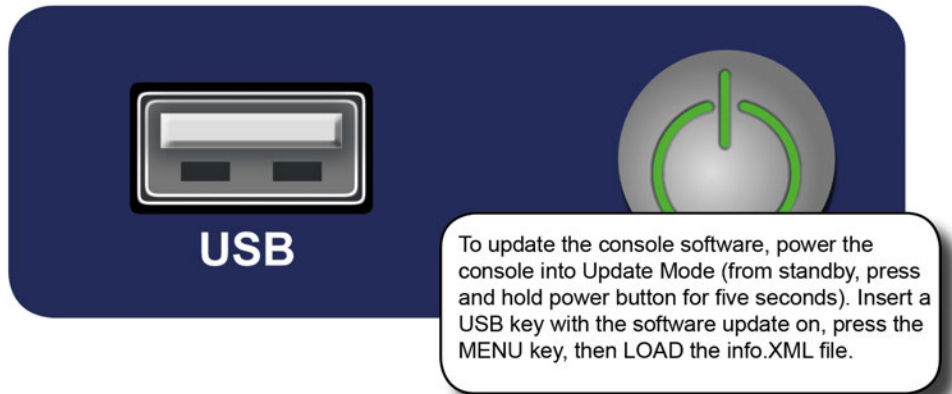

The Si EXPRESSION software is updated via the USB port on the front panel. Details and special instructions for any release will be included with the software release package; however, the 'normal' procedure is listed below for reference:

1. Unzip the files to a USB key in the root directory, you should have two or three files: Expression.bin; info.xml; PerformerFader.hex (optional, see release notes).
2. Switch the console off using the Power key (Press and hold Power Key until it flashes orange, then press it again).
3. Press and hold the Power key for approx 5 seconds. A Software Loader screen shall appear.
4. Insert the USB stick and then press the MENU key.
5. Select the info.xml file using the adjust encoder. The LOAD button at the bottom right of the touch screen window will appear when a valid selection is made.
6. Press the LOAD button. Software will begin loading.
7. Wait until both progress bars have reached 100%, and the 'tick' symbol has appeared to the right of each progress bar, before removing the USB stick.

NOTE: Always follow on-screen instructions and release notes as updates to fader firmware or similar may require additional user input.

The following procedure will restore the console back to the factory defaults and re-format the internal SD card. DO NOT do this if you wish to keep saved data (Shows).

You can use the RESET options in the SYSTEM menu to set parameters and settings back to factory default without destroying data.

Remember: All settings, cues, users, profiles and shows will be lost.

1. Starting with the console off, hold the POWER key for ~5 seconds until the console starts.
2. Press the MENU key once the loader screen appears.
3. Press the LR, MONO and FX1 keys together, this opens the update page.
4. Press the CLEAR SD CARD button on the touch screen.
5. Restart the console.

OSCILLATOR

The console's internal Oscillator is a signal generator provided for various test purposes. It can generate either a sine wave or pink noise (equal power per octave) and has various routing options to Mix and Matrix busses, as well as a patchable physical output.



It is not possible to route directly to the console's LR and MONO buses, though you can route the Oscillator signal to a Mix bus master then use the LR and MONO routing keys.

Oscillator patching is stored in Snapshots; Oscillator settings default to Off following a power cycle.



Route To MIX / MTX

Route the oscillator signal to individual Mix and Matrix busses.

Oscillator routing to each bus has to be enabled using the SOLO button on that Bus Master.



Route To All

Route the oscillator to all Mix and Matrix busses.



Level

Set the Oscillator signal level.

OSCILLATOR



Frequency

Set the frequency for the Oscillator's Sine output.



Type

Set the signal type for the Oscillator output.

Either Sine Wave or Pink Noise (Full spectrum, equal power per octave).



Oscillator Out Patch

Set a physical output for the Oscillator signal

Touching or selecting the value field will bring up a normal patching screen in the Touch Screen. See Section 5.0 for more details.

NO SOUND?

A Troubleshooting Guide.

One of the most common problems experienced with mixing consoles is finding that an input isn't appearing at an output. There are many possible reasons for this, but the best way to troubleshoot it is to first make sure the Control Channel is set up correctly and to go through the signal path and work out where the 'break' is...

You can check the exact audio path of any signal by referring to the signal path diagrams in Chapter 6.

Are Solos inactive?

If the SOLO CLR button is lit red, then there a channel is soloed and all other channels may be muted. This shouldn't affect a main Left/Right or Mono output unless Solo In Place is enabled in the SOLO menu. Also, if Solo mode is 'Auto' the system may be switching to AFL - with faders down you will lose signal. Switch Solo Mode in the SOLO menu.

Clear all active Solos by pressing the SOLO CLR button.

Are the Control Channel, Input Channel, and Input Patch correct?

The physical input should be patched to an Input Channel, and that Input Channel should be controlled by a Control Channel.

For example, by default (factory settings) Mic/Line Input 1 is patched to mono Input Channel CH 01, which is controlled by the Control Channel in Slot 1, Fader Layer A. The other default patches are listed at 5.2.

You can check which Control Channel is controlling which Input Channel in the FADER SETUP menu (See 3.2.1).

You can check which physical input is patched to an Input Channel by selecting the relevant Control Channel. The Input Patch menu item (INPUTS from main Touch Screen Menu) will show the currently patched physical input. See reference 5.1 for more patching detail.

Is there anything on the meters?

By checking the Input and Output path meters, you should be able to localise a problem to a large extent.

The Input channel metering comes after the Mic/Line input but before the rest of the Input Channel. Therefore, if the input signal is valid, the input is patched correctly, you have selected the correct Control Channel (SEL button), and you have applied enough Gain, you should see a level indication on the meters in the IN section of the Assignable Channel Strip (7.2.1).

Output Channel metering is tapped just before the physical output patch.

Are they 'in phase'?

Phase is only likely to cause an issue if coherent signals are applied to more than one channel and they are both routed the same way. For example, you might be using a test signal, or using two channels for the same signal.

You can check if phase is an issue by switching the Phase by 180 degrees on ONE of those channels (use the PHASE button for that audio channel in the IN section of the ACS - 7.2.1). If the audio comes back, then look for the cause of the phase issue - it may be that a balanced connection has been wired incorrectly, for example.

NO SOUND?

Is the Gate shut?

It is possible for an incorrectly set Gate process to stop all signal.

This happens most often when the threshold is set too high and the signal never gets loud enough to 'open' the Gate. You can easily check this by turn the Gate process off with the GATE button in the GATE section of the ACS (7.2.2).

If there is an Insert Point assigned, is the signal returned?

An insert point interrupts the signal flow by patching in a physical output and a physical input. If the signal is not being returned at the Insert Return (or there is no Insert Return patch) then signal will stop there.

The easiest way to check is to check the INSERT page from the Touch Screen Main menu. If the problem channel has an Insert Point assigned, check that both the Insert Send and Return for that Insert Point have valid patches and that the signal is being returned (from an external processor, for example). //Reference section 5.1 has specific information on Insert patching.

Is the Channel on and unmuted?

If a Control Channel ON button is either not lit, or is illuminated red (part of an active Mute Group) then this will mute the signal. Turn off the relevant Mute group or press the ON button to correct the problem.

The basic ON button operation is described in section 7.3, while Mute Groups are covered in section 8.1.

Is the Fader up?

The Fader need to be set high enough when routing to any post-fade destination. If your problem output route is set pre-fader, then this will not affect anything.

You can check the Pre/Post routing of any Mix Bus from an Input Channel in the INPUTS menu - Per Mix Post/Pre (6.1.1).

Is the channel panned to a valid output?

If a signal is panned to the right and no right output exists - either because it isn't patched, or because there is another problem with the right-hand path - then no signal will be heard.

Set Pan to the middle to make sure this isn't a problem.

NO SOUND?

Is the Signal Routed to a valid output bus or channel?

Routing can cover LR and Mono routing, as well as Mix bus routing.

This will depend on the particular instance. If the issue is no output at the main LR or mono outputs for example, then check that the signal is routed using the LR and/or MONO buttons in the ACS OUT section (7.2.5). If the issue is with a Mix Bus or Matrix output, then check contribution to that bus is turned up (see the tOTEM / FADER FOLLOW section 3.5).

Is the Output Master Channel Path valid?

Almost exactly the same checks as above can be done on the Output Master Channel, whether it's a MIX, MATRIX, or LR / M Master.

For detailed path troubleshooting check the signal path diagrams in section 6, as the path order may be slightly different, otherwise run through the same checks as above but for the Output channel.

Is the Output Patch Valid?

To check the physical output patch, select the relevant Bus Master Channel and then go to the OUTPUTS menu in the Touch Screen.

There are two ways to access an Output Master Channel: Either press the relevant tOTEM / FADER FOLLOW button (the MONO/SEL Control channel becomes the Master and is selected automatically) or choose the correct Fader Layer and Select (SEL button) the channel.
