



## Installation Instructions

Instructions d'installation  
Installationsanweisungen  
Instrucciones de instalación  
Istruzioni per l'installazione  
Installatie-instructies  
インストール手順  
安装指示  
إرشادات التركيب

 **Devices must be installed in an approved enclosure by a qualified electrician in accordance with all national and local electrical and construction codes and regulations.**

Les appareils doivent être installés dans un lieu jugé apte, par un électricien qualifié et conformément aux règles et normes locales et nationales en matière d'électricité et de construction.

Die Geräte müssen von einem geprüften Elektriker entsprechend allen nationalen und lokalen Elektro- und Bauvorschriften in einem zugelassenen Gehäuse installiert werden.

Los dispositivos se deben instalar en un recinto aprobado por un electricista cualificado de acuerdo a todos los reglamentos eléctricos y de construcción locales y nacionales pertinentes

I dispositivi devono essere installati da un elettricista qualificato in un luogo approvato, in conformità a tutti gli standard e le norme nazionali e locali vigenti in materia di impianti elettrici e costruzioni edilizie.

Apparaten moeten door een erkende elektricien worden geïnstalleerd in een goedgekeurde behuizing in overeenstemming met alle nationale en lokale elektriciteits- en bouwvoorschriften en wetgeving.

デバイスを取り付ける際は、資格のある電気技師に依頼し、電気と建設に関する国および地域のすべての法令に従って、認可されている筐体内に取り付けてください。

根据国家/地区及当地的电气与建筑规范和法规，该设备必须由有资质的电工安装在经批准的外罩内。

يلزم تركيب الأجهزة داخل حاوية معتمدة، من قبل كهربائي مؤهل وفقاً لجميع قوانين ولوائح الكهرباء والإنشاءات الوطنية والمحلية

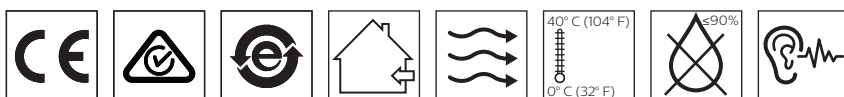
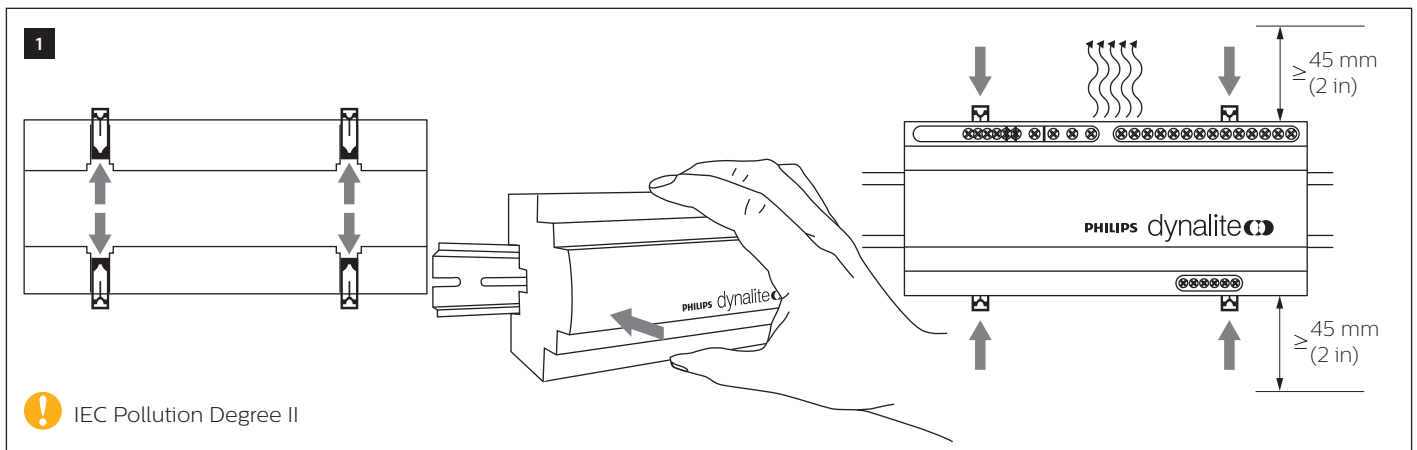
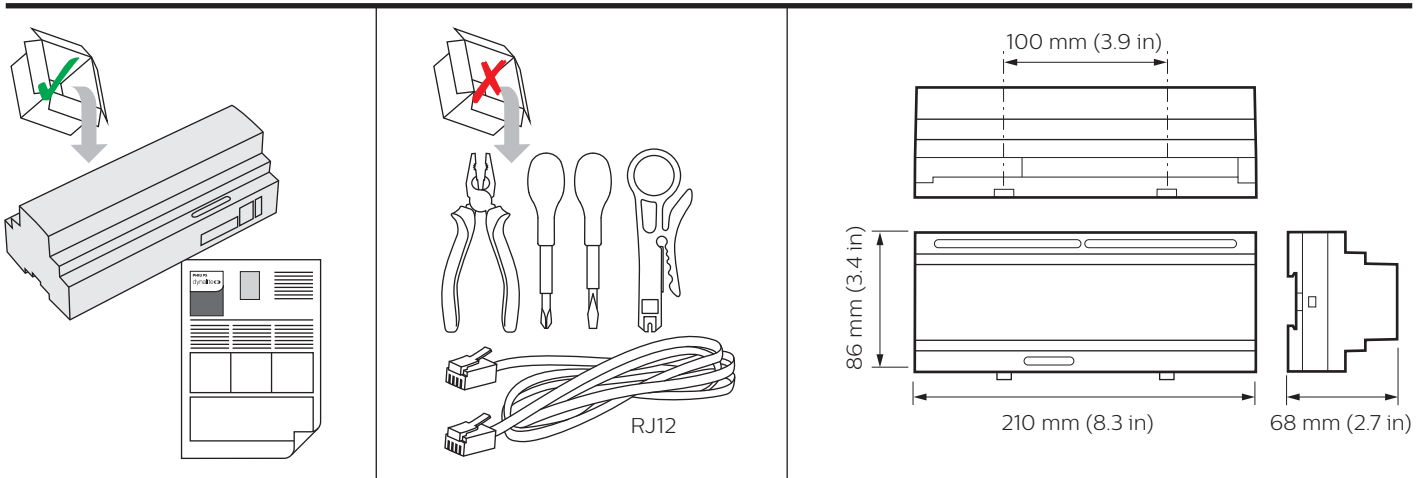

2

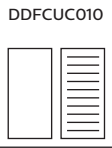

Specification sheet  
 Fiche technique  
 Datenblatt  
 Hoja de especificaciones  
 Foglio di specifiche  
 Technische fiche  
 仕様書シート  
 规格表  
 ورقة المواصفات

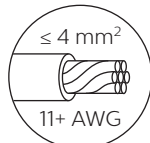

$A + B \leq 4 W$

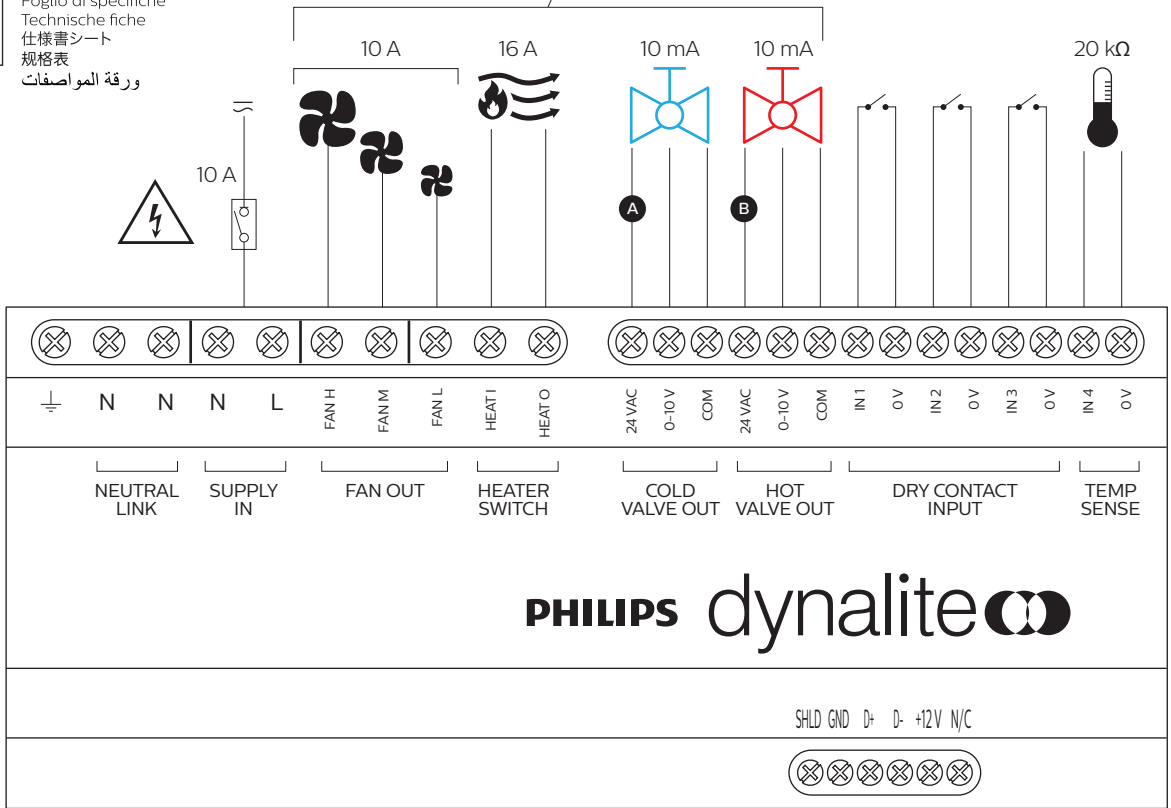

3

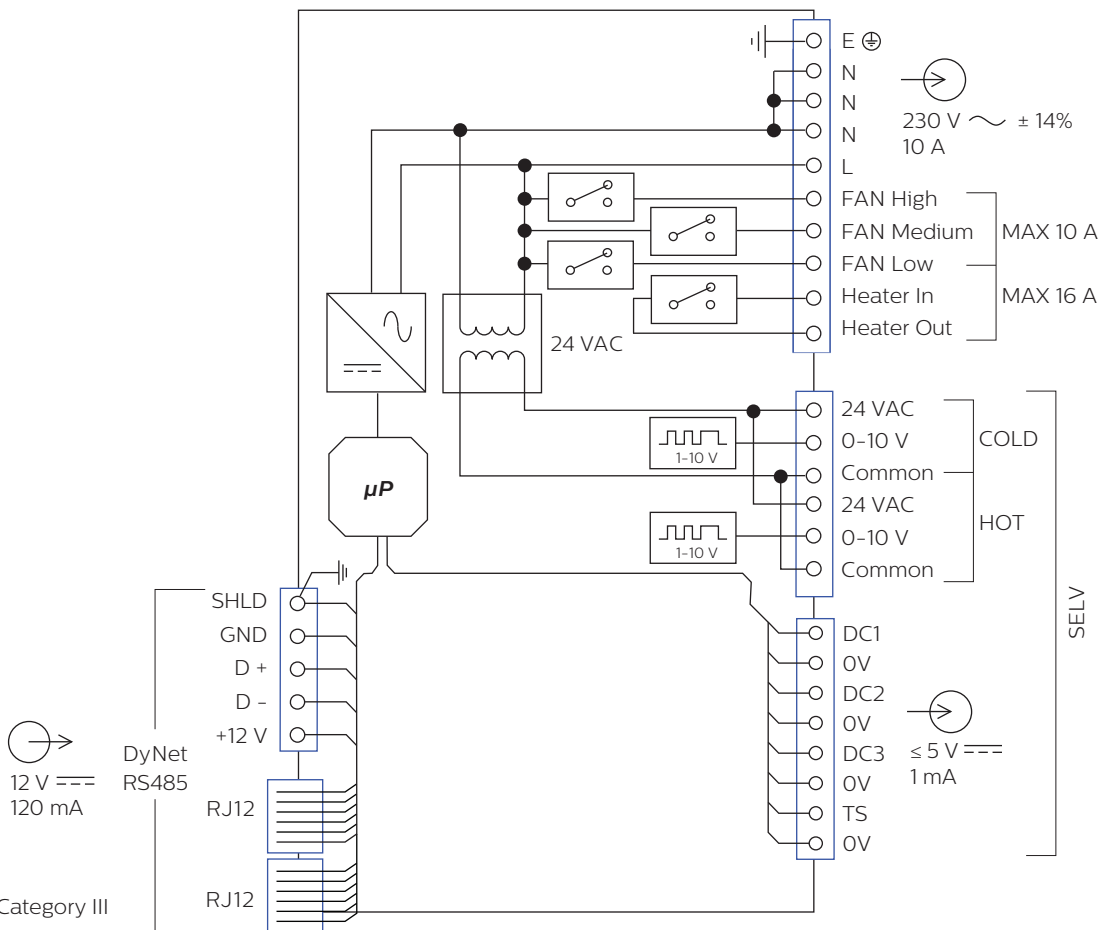

IEC Overvoltage Category III

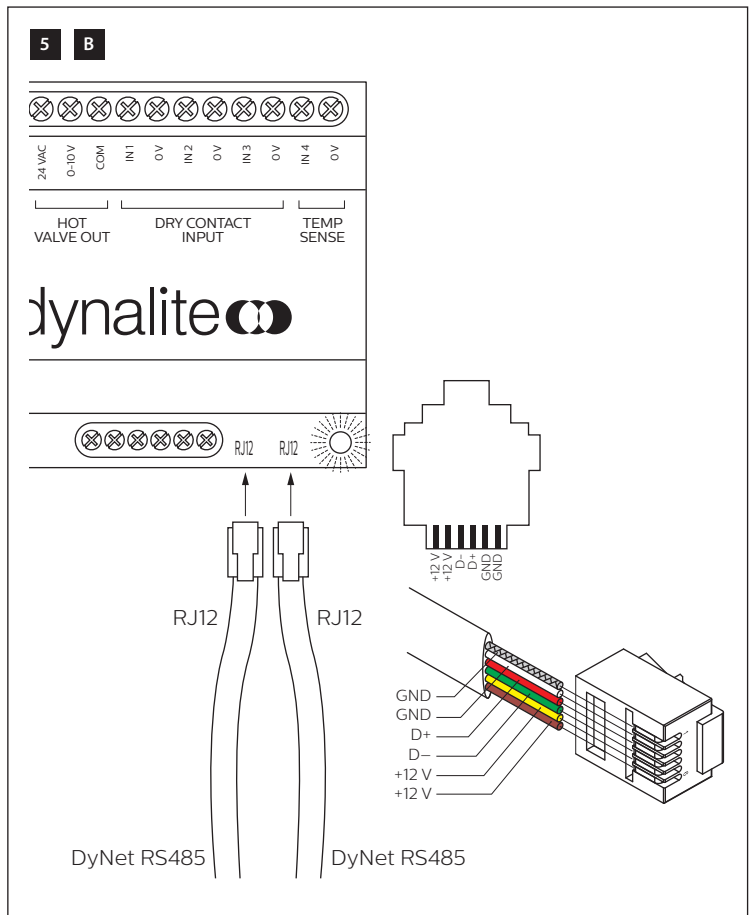
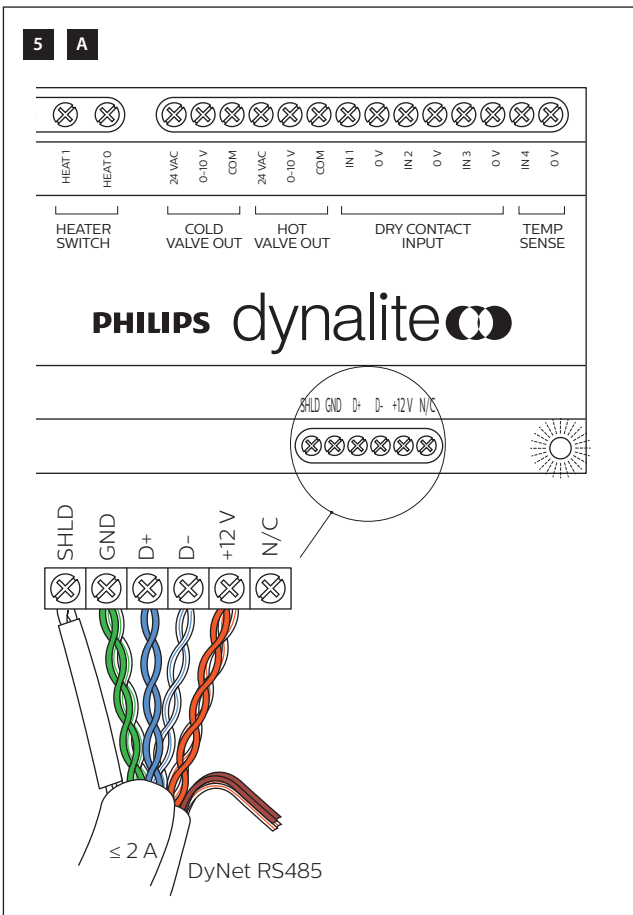
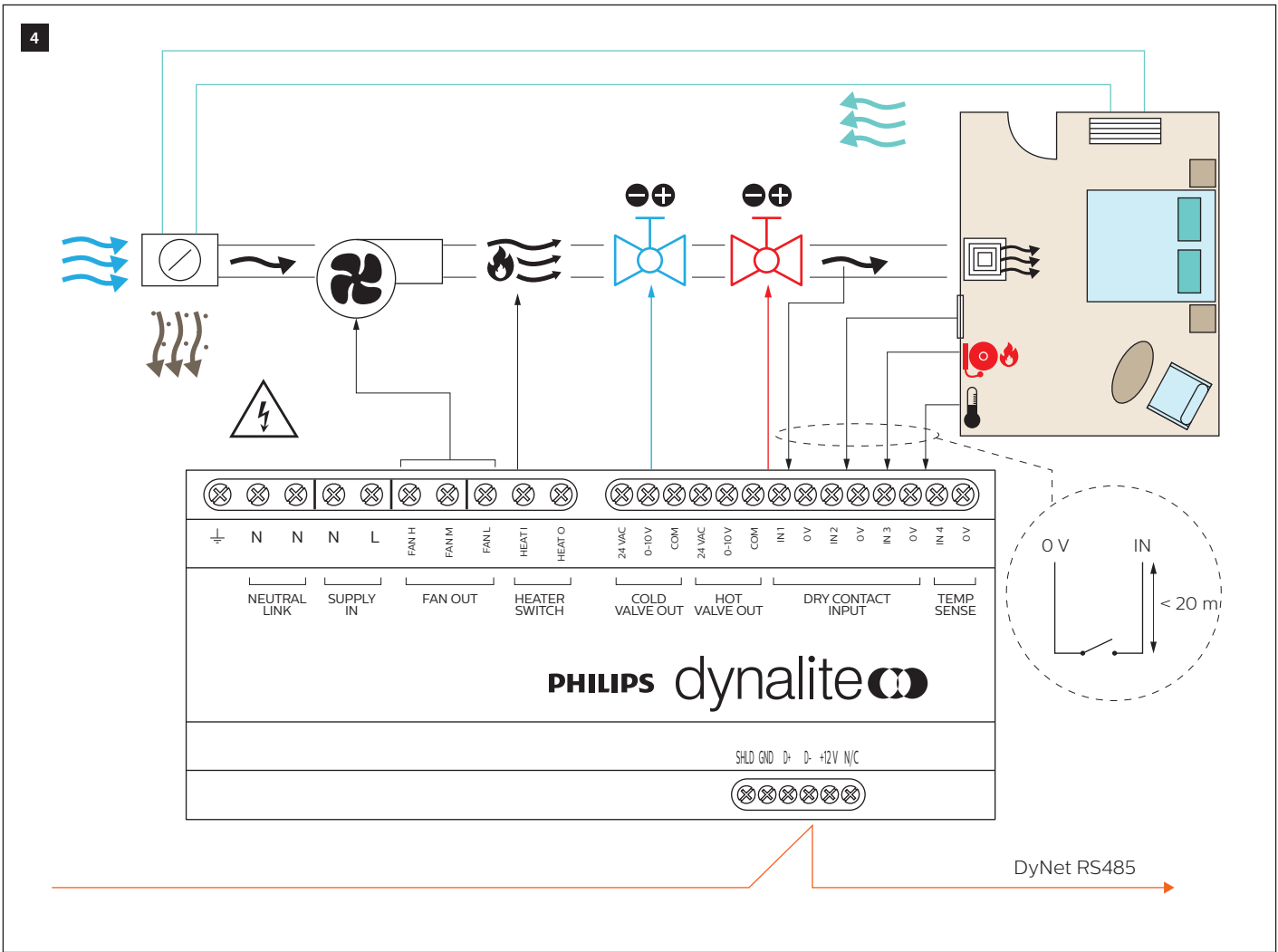

6

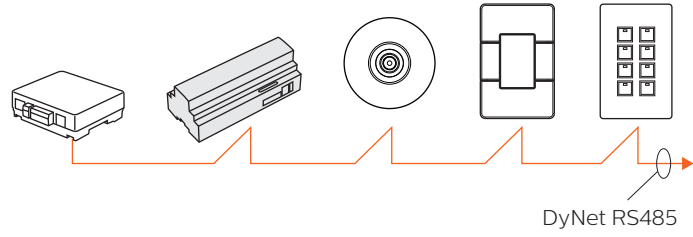

7

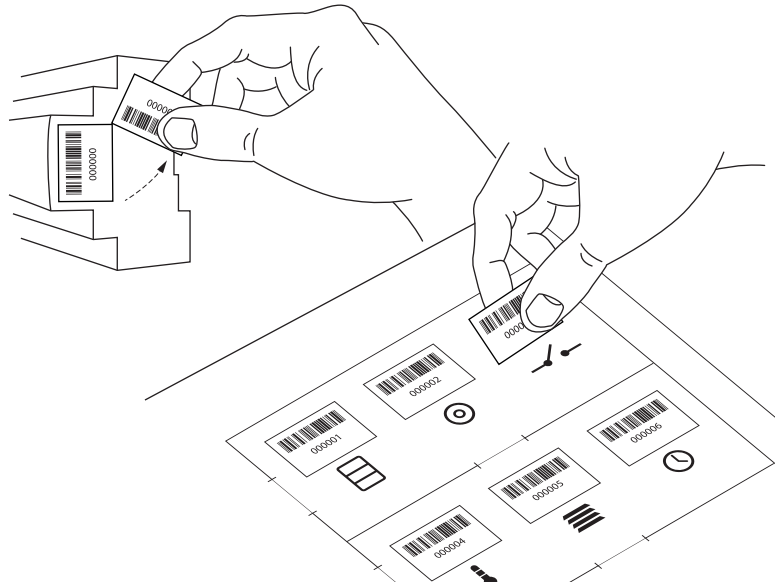

 This is a class A product. In a domestic environment this product may cause radio interference, in which case the user may be required to take adequate measures.

