



Date: _____ Type: _____

Firm Name: _____

Project: _____

SkyRibbon

IntelliHue Wall Washing Powercore, 70° × 95° spread lens

Recessed linear interior LED wall washing fixture with intelligent white and color light

Introducing SkyRibbon IntelliHue Wall Washing Powercore, a recessed linear interior LED wall washing fixture offering high-quality intelligent color and white light from the same fixture. IntelliHue is an advanced approach to color mixing that gives users the ability to precisely target a full spectrum of saturated color and high-quality white light, granting an unprecedented level of design freedom. Brilliant light output and industry-leading controls make fixtures ideal for a variety of interior wall washing applications. Users can rotate LED modules from 0° to 90° to evenly wash walls top to bottom regardless of fixture setback. Multiple housing options accommodate a number of installation methods.

- Color-changing and high-quality white light from the same fixture — IntelliHue is an advanced approach to color mixing that enables high-quality intelligent color and white light from a single fixture. Multiple channels of LED light sources combine to produce a full spectrum of precisely controllable light, including millions of saturated colors, pastels, and uniform white light with CRI of greater than 85 in the 2700 K – 4000 K range.
- Tunable white light — Select color temperatures from 2000 K – 10,000 K with CRI greater than 85 in the 2700 K – 4000 K range.
- Purposefully move off the Black Body Curve — Create pastels and shades of white to match hues of other technologies, such as halogen or fluorescent.
- High-quality illumination in a variety of beam angles — Native 20° × 20° beam angle. Holographic diffusion lenses offer additional 30° × 30°, 65° × 65°, 70° × 95°, and 90° × 90° beam angle options for design flexibility.

- Multiple housing options for installation and mounting flexibility — T-Bar, Flanged, and Flangeless housings support numerous installation methods and appearances.
- Integrates patented Powercore technology — Powercore rapidly, efficiently, and accurately controls power output to fixtures directly from line voltage. Philips Data Enabler Pro merges line voltage and control data and delivers them to fixtures over a single standard cable, dramatically simplifying installation and lowering total system cost.
- Superior color consistency and accuracy — Optibin, an advanced binning algorithm, sets a new standard for the color consistency and uniformity of LED sources used in manufacturing. Chromasync technology achieves unprecedented consistency of light performance and color precision while maximizing intensity and color range. With Chromasync enabled, SkyRibbon IntelliHue Powercore offers color variation of less than 2 MacAdam ellipses (2 SDCM) across multiple fixtures in an installation — imperceptible to the human eye.
- Industry-leading controls — Fixtures work seamlessly with the complete Philips Color Kinetics line of controllers, including Light System Manager, iPlayer 3, and ColorDial Pro, as well as third-party controllers.
- Three voltage options — Available 120 VAC, 220 – 240 VAC, and 277 VAC fixtures ensure consistent operation in a number of major international regions.

For detailed product information, please refer to SkyRibbon IntelliHue Wall Washing Powercore Product Guide at www.philipscolorkinetics.com/ls/intellihue/skyribbon-wall-washing/

PHILIPS

CE Dimensional Diagrams

SkyRibbon Wall Washing Powercore Flanged Housing, 220 – 240 VAC

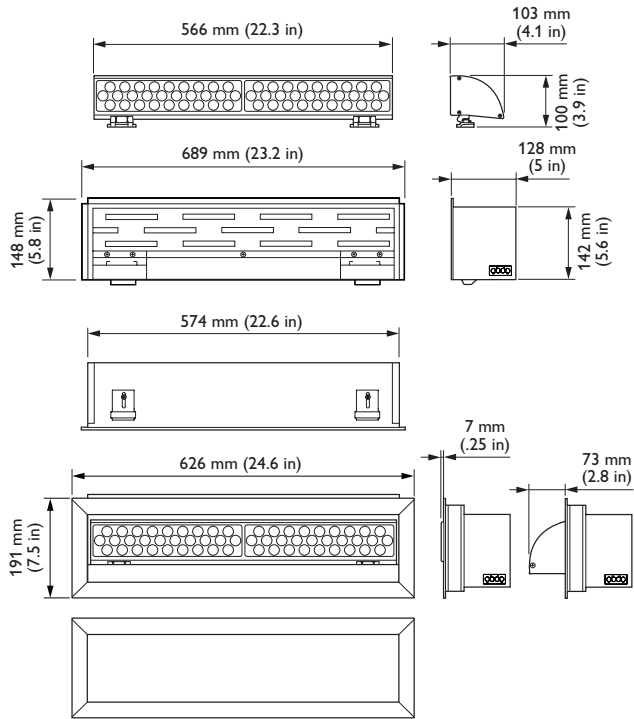

SkyRibbon Wall Washing Powercore Flangeless Housing, 220 – 240 VAC

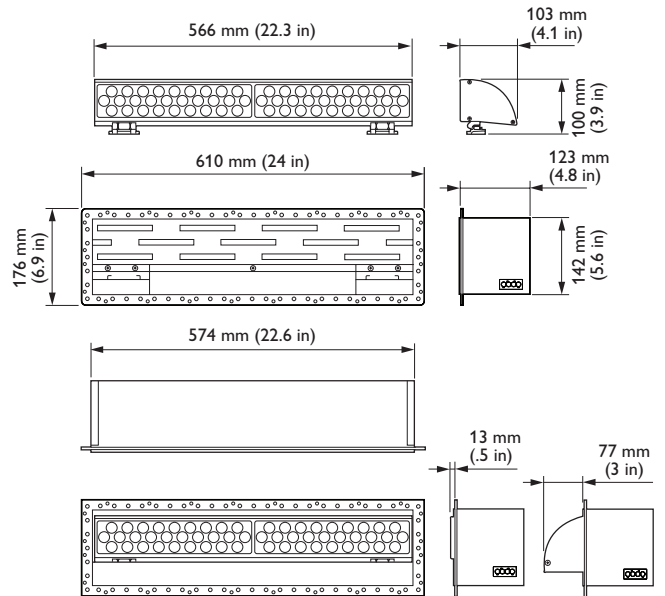

SkyRibbon Wall Washing Powercore T-Bar Housing, 220 – 240 VAC

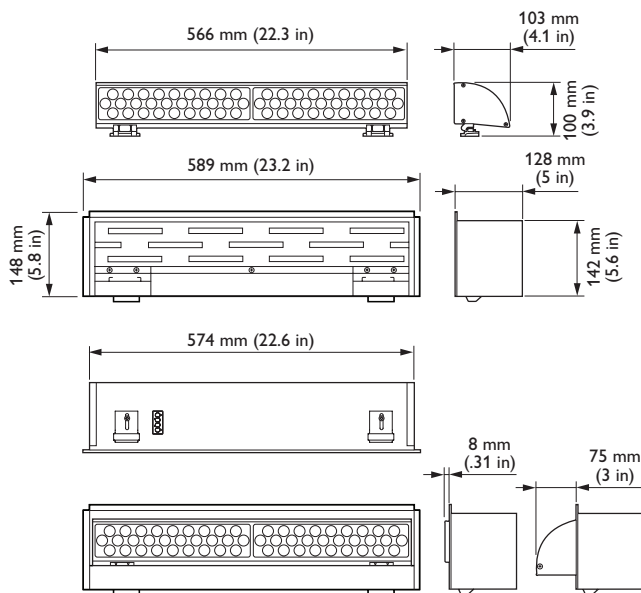

SkyRibbon Wall Washing Powercore Slotted-T Housing, 220 – 240 VAC

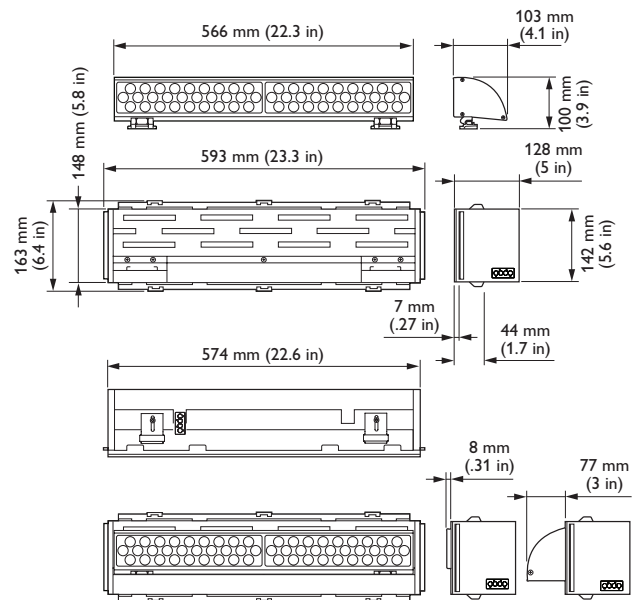

UL Dimensional Diagrams

SkyRibbon Wall Washing Powercore Flanged Housing, 120 VAC / 277 VAC

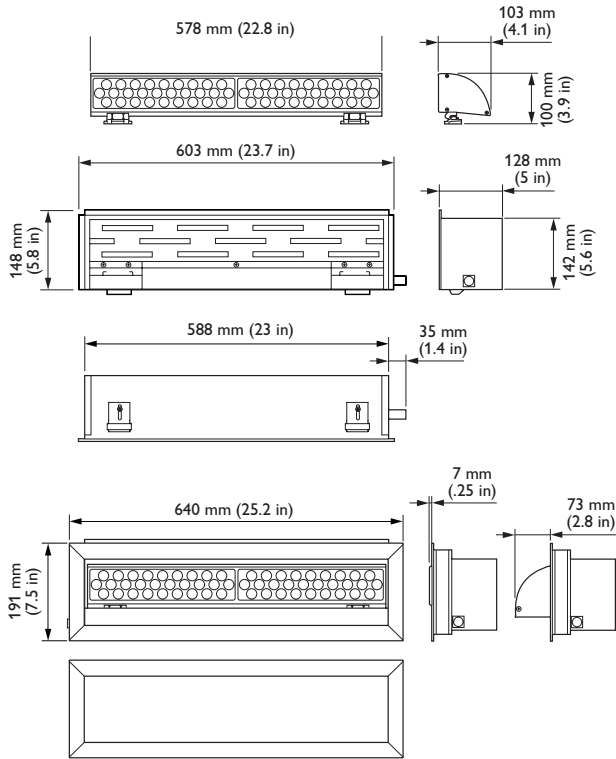

SkyRibbon Wall Washing Powercore Flangeless Housing, 120 VAC / 277 VAC

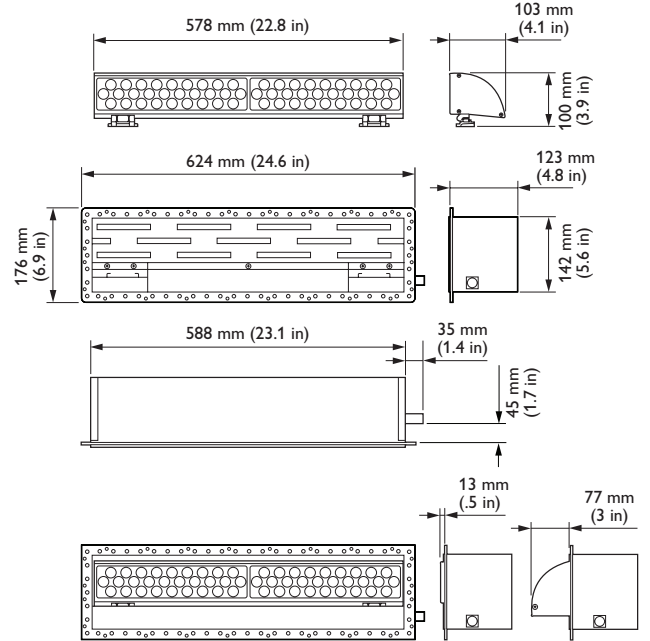

SkyRibbon Wall Washing Powercore T-Bar Housing, 120 VAC / 277 VAC

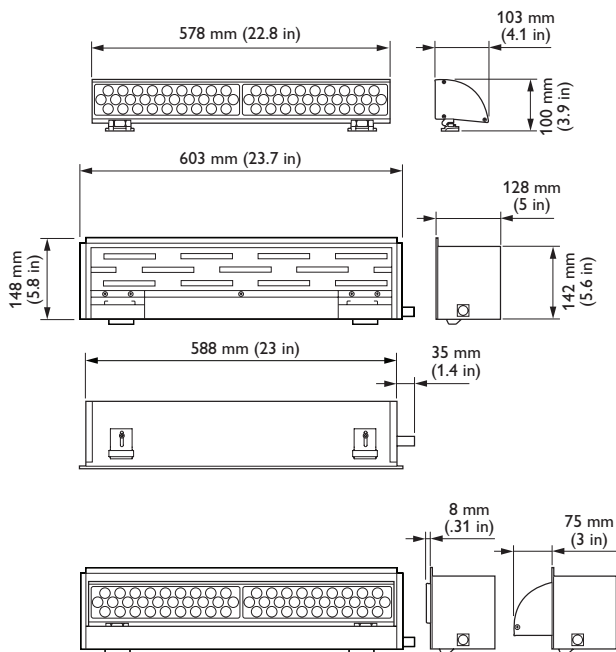

SkyRibbon Wall Washing Powercore Slotted-T Housing, 120 VAC / 277 VAC

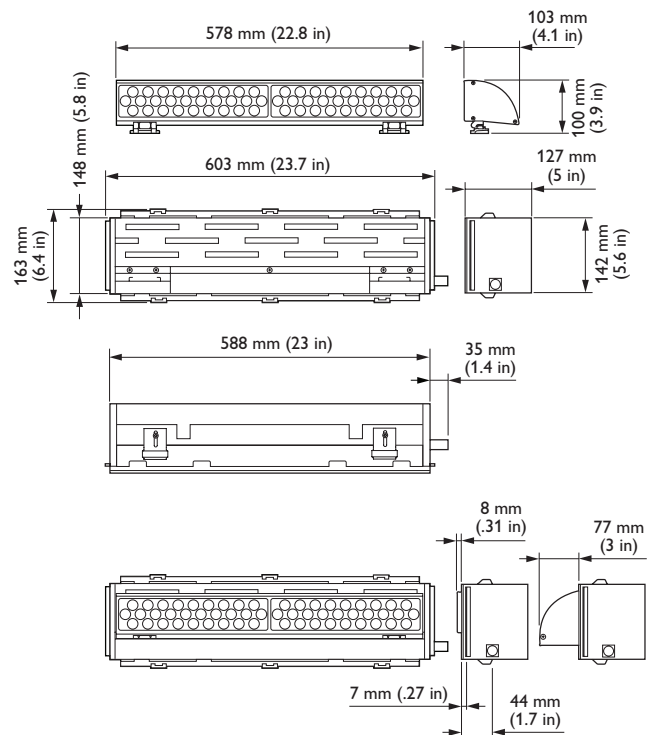

Photometrics / SkyRibbon IntelliHue Wall Washing Powercore, 70° x 95° spread lens

Photometric data is based on test results from an independent NIST traceable testing lab. IES data is available at www.philipscolorkinetics.com/support/ies.

RGB channels only, full on

Lumens	Efficacy
1179	27.1 lm /W

Polar Candela Distribution

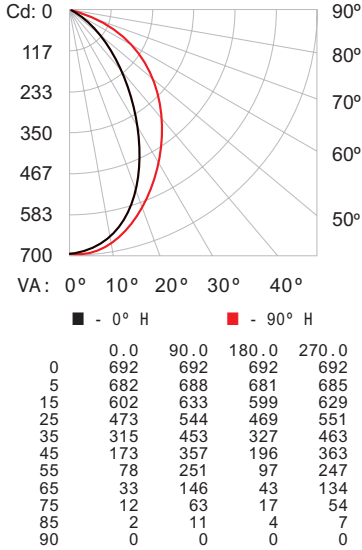

Illuminance at Distance

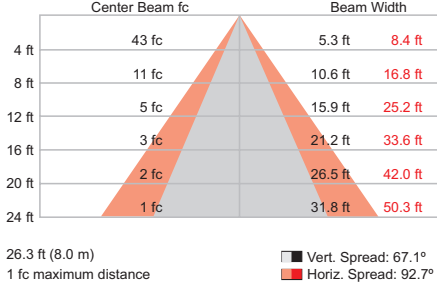

Coefficients Of Utilization - Zonal Cavity Method

Effective Floor Cavity Reflectance: 20%

RC	80	70	50	30	10	0
RW	70 50 30 10	70 50 30 10	50 30 10	50 30 10	50 30 10	0
0	119119119119	116116116116	1111111111	106106106	102102102	100
1	111107104100	108105102 99	101 98 96	97 95 93	93 92 90	88
2	103 96 90 85	100 94 89 84	91 86 82	87 84 81	85 82 79	77
3	95 86 79 74	93 85 78 73	82 76 72	79 74 71	77 73 69	67
4	88 78 70 64	86 76 69 64	74 68 63	72 67 62	70 65 62	60
5	82 71 63 57	80 69 62 57	67 61 56	66 60 55	64 59 55	53
6	76 64 56 51	74 64 56 51	62 55 50	60 54 50	59 53 49	48
7	71 59 51 46	70 58 51 46	57 50 45	55 49 45	54 49 45	43
8	67 54 47 41	65 54 46 41	53 46 41	51 45 41	50 45 41	39
9	63 50 43 38	61 50 43 38	49 42 38	48 42 37	47 41 37	36
10	59 47 40 35	58 46 39 35	45 39 35	45 39 34	44 38 34	33

Zonal Lumen

ZONE	LUMENS	%FIXT
0- 30	469	39.8
0- 40	712	60.4
0- 60	1060	90.0
0- 90	1179	100.0
90-180	0	0.0
0-180	1179	100.0

2700 K

Lumens	Efficacy
1869	42.8 lm /W

Polar Candela Distribution

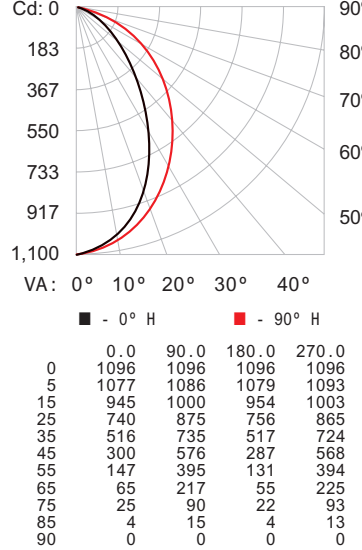

Illuminance at Distance

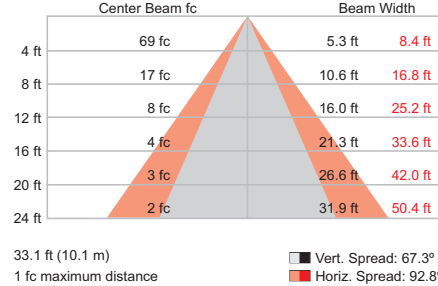

Coefficients Of Utilization - Zonal Cavity Method

Effective Floor Cavity Reflectance: 20%

RC	80	70	50	30	10	0
RW	70 50 30 10	70 50 30 10	50 30 10	50 30 10	50 30 10	0
0	119119119119	116116116116	1111111111	106106106	102102102	100
1	111107104101	108105102 99	101 98 96	97 95 93	93 92 90	88
2	103 96 90 85	100 94 89 84	91 86 83	87 84 81	85 82 79	77
3	95 86 79 74	93 85 78 73	82 76 72	79 74 71	77 73 69	68
4	88 78 70 64	86 76 69 64	74 68 63	72 67 62	70 65 62	60
5	82 71 63 57	80 70 62 57	68 61 56	66 60 56	64 59 55	53
6	76 64 56 51	74 64 56 51	62 55 50	60 54 50	59 54 49	48
7	71 59 51 46	70 58 51 46	57 50 45	56 50 45	54 49 45	43
8	67 54 47 42	65 54 47 41	53 46 41	51 45 41	50 45 41	39
9	63 50 43 38	61 50 43 38	49 42 38	48 42 37	47 41 37	36
10	59 47 40 35	58 46 39 35	45 39 35	45 39 35	44 38 34	33

Zonal Lumen

ZONE	LUMENS	%FIXT
0- 30	745	39.9
0- 40	1131	60.5
0- 60	1682	90.0
0- 90	1869	100.0
90-180	0	0.0
0-180	1869	100.0

4000 K

Lumens	Efficacy
2330	41.2 lm /W

Polar Candela Distribution

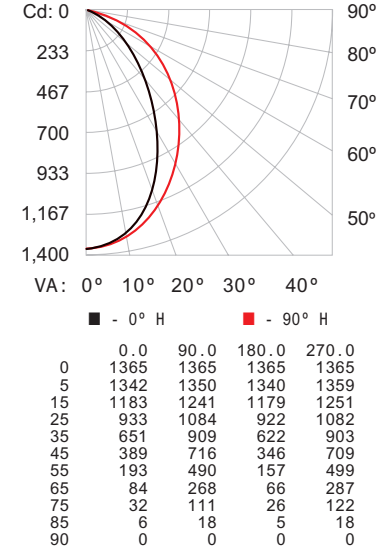

Illuminance at Distance

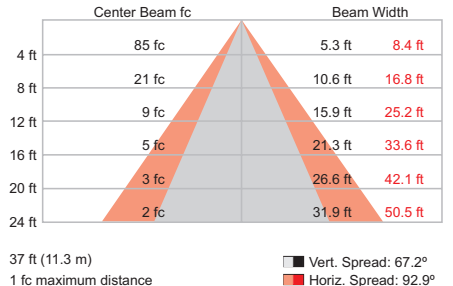

Coefficients Of Utilization - Zonal Cavity Method

Effective Floor Cavity Reflectance: 20%

RC	80	70	50	30	10	0
RW	70 50 30 10	70 50 30 10	50 30 10	50 30 10	50 30 10	0
0	119119119119	116116116116	1111111111	106106106	102102102	100
1	111107104100	108105102 99	101 98 96	97 95 93	93 92 90	88
2	103 96 90 85	100 94 89 84	91 86 82	87 84 81	85 82 79	77
3	95 86 79 74	93 85 78 73	82 76 72	79 74 71	77 73 69	67
4	88 78 70 64	86 76 69 64	74 68 63	72 67 62	70 65 62	60
5	82 71 63 57	80 69 62 57	67 61 56	66 60 56	64 59 55	53
6	76 64 56 51	74 64 56 51	62 55 50	60 54 50	59 53 49	48
7	71 59 51 46	70 58 51 46	57 50 45	56 50 45	54 49 45	43
8	67 54 47 41	65 54 46 41	53 46 41	51 45 41	50 45 41	39
9	63 50 43 38	61 50 43 38	49 42 38	48 42 37	47 41 37	36
10	59 47 40 35	58 46 39 35	45 39 35	45 39 35	44 38 34	33

Zonal Lumen

ZONE	LUMENS	%FIXT
0- 30	927	39.8
0- 40	1407	60.4
0- 60	2096	90.0
0- 90	2330	100.0
90-180	0	0.0
0-180	2330	100.0

For lux multiply fc by 10.7

Specifications / SkyRibbon IntelliHue Wall Washing Powercore, 70° x 95° spread lens

Due to continuous improvements and innovations, specifications may change without notice

Item	Specification	RGB channels only, full on	2700 K*	4000 K*
Output	Lumens†	1179	1869	2330
	Efficacy (lm / W)	27.1	42.8	41.2
	CRI	—	90	88
	Power Factor	.913 @ 120 VAC	.913 @ 120 VAC	.943 @ 120 VAC
	LED Channels	Red / Green / Blue / Mint White / 4000 K		
	Lumen Maintenance‡	60,000 hours L70 @ 25° C 50,000 hours L70 @ 40° C 100,000 hours L50 @ 25° C 80,000 hours L50 @ 40° C		
Electrical	Input Voltage	120 VAC, 220 – 240 VAC, 277 VAC, 50 / 60 Hz		
	Power Consumption	66 W maximum at full output, steady state		
Control	Interface	Data Enabler Pro (DMX / Ethernet)		
	Control System	Philips Color Kinetics full range of controllers, including Light System Manager and iPlayer 3, or third-party controllers		
Physical	Housing Material	Steel, white powder-coated finish		
	Lens	Polycarbonate		
	Fixture Connections	7 in (178 mm) flying leads, integral male / female connectors (120 / 277 VAC) Wieland integral male / female connectors (220 – 240 VAC)		
	Temperature Ranges	-4° – 104° F (-20° – 40° C) Operating -4° – 104° F (-20° – 40° C) Startup -40° – 176° F (-40° – 80° C) Storage		
	Fixture Run Lengths	To calculate fixture run lengths and total power consumption for your specific installation, download the Configuration Calculator from www.philipscolorkinetics.com/support/install_tool/		
	Humidity	0 – 95%, non-condensing		
Certification and Safety	Certification	UL / cUL, CE, FCC Class A		
	Environment	Dry / Damp Location, IP20		

* Color temperatures conform to nominal CCTs as defined in ANSI Chromaticity Standard C78.377A.

† Lumen measurement complies with IES LM-79-08 testing procedures.

‡ L70 = 70% lumen maintenance (when light output drops below 70% of initial output).

L50 = 50% lumen maintenance (when light output drops below 50% of initial output). Ambient luminaire temperatures specified. Lumen maintenance calculations are based on lifetime prediction graphs supplied by LED source manufacturers. Calculations for white-light LED fixtures are based on measurements that comply with IES LM-80-08 testing procedures. Refer to www.philipscolorkinetics.com/support/appnotes/lm-80-08.pdf for more information.



Dimensions and Weight

Fixture		Flanged	Flangeless	T-Bar	Slotted-T
120 VAC / 277 VAC	Housing Dimensions (Height x Width x Depth)	5.8 x 23.7 x 5 in	6.9 x 24.6 x 4.8 in	5.8 x 23.7 x 5 in	6.4 x 23.7 x 5 in
	Assembled Weight†	10.4 lbs	8.6 lbs	8.6 lbs	8.6 lbs
220 – 240 VAC	Housing Dimensions (Height x Width x Depth)	148 x 689 x 128 mm	176 x 610 x 123 mm	148 x 589 x 128 mm	163 x 593 x 128 mm
	Assembled Weight†	4.7 kg	3.9 kg	3.9 kg	3.9 kg

† Assembled weight includes fixture housing and LED module.

Product Selection

To order a complete SkyRibbon IntelliHue Wall Washing Powercore fixture, choose a housing (voltage, length, and type), an optional spread lens, an optional accessories..

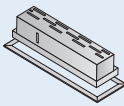
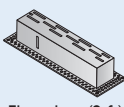
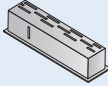
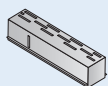
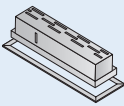
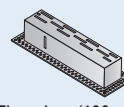
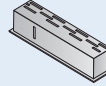
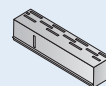
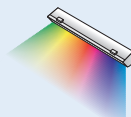
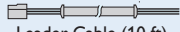
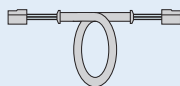
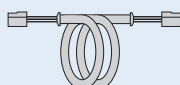
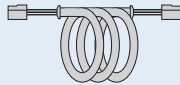
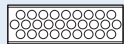
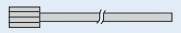
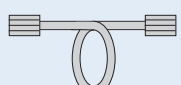
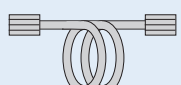
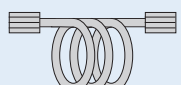
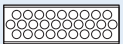
1 Choose housing type		2 Choose LED module	3 Choose optional spread lens	4 Choose accessories	
<div style="display: flex; justify-content: space-between;"> <div style="width: 45%;"> <p>120 VAC or 277 VAC</p>  <p>Flanged (2 ft)</p>  <p>Flangeless (2 ft)</p>  <p>T-Bar (2 ft)</p>  <p>Slot-T (2 ft)</p> </div> <div style="width: 45%;"> <p>220 – 240 VAC</p>  <p>Flanged (600 mm)</p>  <p>Flangeless (600 mm)</p>  <p>T-Bar (600 mm)</p>  <p>Slot-T (600 mm)</p> </div> </div>		 <p>2 ft or 600 mm</p>	<p>30° x 30°</p> <p>30° x 60°</p> <p>35° x 105°</p> <p>40° x 80°</p> <p>65° x 65°</p> <p>70° x 95°</p> <p>90° x 90°</p>	<div style="display: flex; justify-content: space-between;"> <div style="width: 45%;"> <p>120 VAC / 277 VAC</p>  <p>Leader Cable (10 ft)</p>  <p>Jumper Cable (1 ft)</p>  <p>Jumper Cable (4 ft)</p>  <p>Jumper Cable (8 ft)</p>  <p>Louver (2 ft)</p> </div> <div style="width: 45%;"> <p>220 – 240 VAC</p>  <p>Leader Cable (3 m)</p>  <p>Jumper Cable (0.9 m)</p>  <p>Jumper Cable (1.4 m)</p>  <p>Jumper Cable (1.7 m)</p>  <p>Louver (600 m)</p> </div> </div>	

For 220—240 VAC installations, you must use leader and jumper cables.

For 120 / 277 VAC installations, you can either use leader and jumper cables or hardwire the fixtures. When hardwiring, the fixture acts as a junction box.

2 ft / 120 VAC or 277 VAC

Item	Voltage	Type	Item Number	Philips 12NC
Housings	120 VAC	Flanged (fixture and flange)	172-000072-02 and 120-000172-09	910503703215 and 910503703274
		Flangeless	172-000072-03	910503703216
		T-Bar	172-000072-02	910503703215
		Slotted-T	172-000072-13	910503704285
	277 VAC	Flanged (fixture and flange)	172-000072-06 and 120-000172-09	910503704247 and 910503703274
		Flangeless	172-000072-07	910503704248
		T-Bar	172-000072-06	910503704247
		Slotted-T	172-000072-15	910503704287

Item	Type	Item Number	Philips 12NC
LED Module	IntelliHue	123-000072-00	910503702668

Item	Beam Angle	Item Number	Philips 12NC
Spread Lenses	30° x 30°	120-000172-01	910503702691
	30° x 60°	120-000172-04	910503702694
	35° x 105°	120-000172-03	910503702693
	40° x 80°	120-000172-02	910503702692
	65° x 65°	120-000172-06	910503702696
	70° x 95°	120-000172-07	910503702697
	90° x 90°	120-000172-08	910503702698

Item		Length	Item Number	Philips 12NC
Leader Cable and Accessories	Leader Cable	10 ft	108-000072-04	910503703985
	Jumper Cable	1 ft	108-000072-00	910503702835
		4 ft	108-000072-01	910503702836
		8 ft	108-000072-02	910503702837
	Louver		120-000172-00	910503702690

Use Item Number when ordering in North America.

Product Selection (continued)

600 mm / 220 – 240 VAC

Item	Type	Item Number	Philips 12NC
Housings	Flanged	172-000072-11	910503704265
	Flangeless	172-000072-19	910503705011
	T-Bar	172-000072-10	910503704264
	Slotted-T	172-000072-17	910503704632

Item	Type	Item Number	Philips 12NC
LED Module	IntelliHue	123-000072-01	910503704253

Item	Beam Angle	Item Number	Philips 12NC
Spread Lenses	30° x 30°	120-000161-01	910503704213
	30° x 60°	120-000161-04	910503704216
	35° x 105°	120-000161-03	910503704215
	40° x 80°	120-000161-02	910503704214
	65° x 65°	120-000161-06	910503704218
	70° x 95°	120-000161-07	910503704219
	90° x 90°	120-000161-08	910503704220

Item		Length	Item Number	Philips 12NC
Leader Cable and Accessories	Leader Cable	3 m	108-000072-14	910503705048
		0.9 m	108-000072-15	910503705049
	Jumper Cable	1.4 m	108-000072-16	910503705050
		1.7 m	108-000072-17	910503705051
	Louver		120-000161-00	910503704249

Use Item Number when ordering in North America.



Philips Color Kinetics
 3 Burlington Woods Drive
 Burlington, Massachusetts 01803 USA
 Tel 888.385.5472
 Tel 617.423.9999
 Fax 617.423.9998
www.philipscolorkinetics.com

Copyright © 2013–2015 Philips Solid-State Lighting Solutions, Inc. All rights reserved. Chromacore, Chromasic, CK, the CK logo, Color Kinetics, the Color Kinetics logo, ColorBlast, ColorBlaze, ColorBurst, eW Fuse, ColorGraze, ColorPlay, ColorReach, iW Reach, eW Reach, DIMand, EssentialWhite, eW, iColor; iColor Cove, IntelliWhite, iW, iPlayer, Optibin, and Powercore are either registered trademarks or trademarks of Philips Solid-State Lighting Solutions, Inc. in the United States and / or other countries. All other brand or product names are trademarks or registered trademarks of their respective owners. Due to continuous improvements and innovations, specifications may change without notice.

DAS-000121-04 R02 3-15