

Date: _____ Type: _____

Firm Name: _____

Project: _____

SkyRibbon

IntelliHue Wall Grazing Powercore, 10° × 10° native (no spread lens)

Recessed linear interior LED wall grazing fixture with intelligent white and color light

Introducing SkyRibbon IntelliHue Wall Grazing Powercore, a recessed linear interior LED wall grazing fixture offering high-quality intelligent color and white light from the same fixture. IntelliHue is an advanced approach to color mixing that gives users the ability to precisely target a full spectrum of saturated color and high-quality white light, granting an unprecedented level of design freedom. Brilliant light output and industry-leading controls make fixtures ideal for a variety of interior wall grazing applications. Multiple housing options accommodate a number of installation methods.

- Color-changing and high-quality white light from the same fixture — IntelliHue is an advanced approach to color mixing that enables high-quality intelligent color and white light from a single fixture. Multiple channels of LED light sources combine to produce a full spectrum of precisely controllable light, including millions of saturated colors, pastels, and uniform white light with CRI of greater than 85 in the 2700 K – 4000 K range.
- Tunable white light — Select color temperatures from 2000 K – 10,000 K with CRI greater than 85 in the 2700 K – 4000 K range.
- Purposefully move off the Black Body Curve — Create pastels and shades of white to match hues of other technologies, such as halogen or fluorescent.
- High-quality illumination in a variety of beam angles — Native 10° × 10° beam angle. Holographic diffusion lenses offer additional 10° × 60°, 10° × 90°, 30° × 30°, and 30° × 60° beam angle options for design flexibility.
- Multiple housing options for installation and mounting flexibility — T-Bar, Slotted-T, Flanged, and Flangeless housings support numerous installation methods and appearances.
- Flexible configuration — Available in 1 ft and 4 ft fixture lengths with multiple jumper cable, corner terminal, and connector options to accommodate nearly any layout.
- Integrates patented Powercore technology — Powercore rapidly, efficiently, and accurately controls power output to fixtures directly from line voltage. Philips Data Enabler Pro merges line voltage and control data and delivers them to fixtures over a single standard cable, dramatically simplifying installation and lowering total system cost.
- Superior color consistency and accuracy — Optibin, an advanced binning algorithm, sets a new standard for the color consistency and uniformity of LED sources used in manufacturing. Chromasync technology achieves unprecedented consistency of light performance and color precision while maximizing intensity and color range. With Chromasync enabled, SkyRibbon IntelliHue Powercore offers color variation of less than 2 MacAdam ellipses (2 SDCM) across multiple fixtures in an installation — imperceptible to the human eye.
- Industry-leading controls — Fixtures work seamlessly with the complete Philips Color Kinetics line of controllers, including Light System Manager, iPlayer 3, and ColorDial Pro, as well as third-party controllers.
- Three voltage options — Available 120 VAC, 220 – 240 VAC, and 277 VAC fixtures ensure consistent operation in a number of major international regions.

For detailed product information, please refer to SkyRibbon IntelliHue Wall Grazing Powercore Product Guide at www.philipscolorkinetics.com/ls/intellihue/skyribbon-wall-grazing/

PHILIPS

CE Dimensional Diagrams

SkyRibbon Wall Grazing Powercore Flanged Housing, 220 – 240 VAC

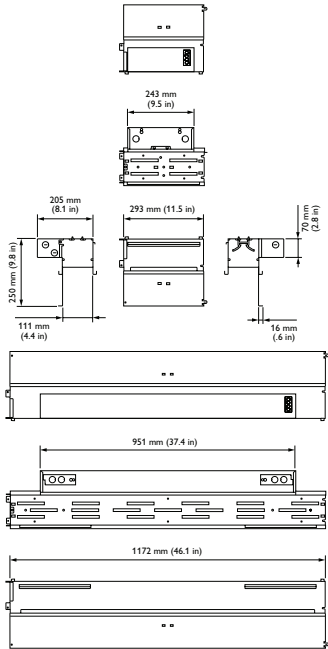

SkyRibbon Wall Grazing Powercore Flangeless Housing, 220 – 240 VAC

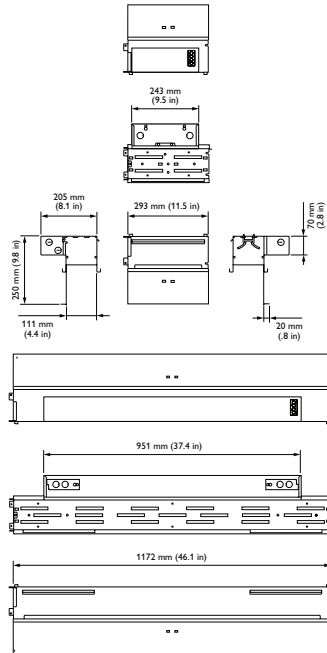

SkyRibbon Wall Grazing Powercore T-Bar / Slotted-T Housing, 220 – 240 VAC

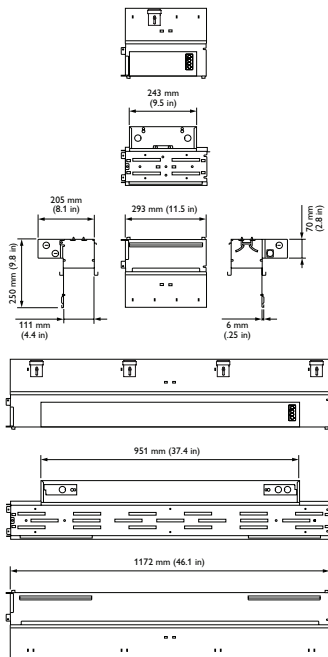

UL Dimensional Diagrams

SkyRibbon Wall Grazing Powercore Flanged Housing, 120 VAC / 277 VAC

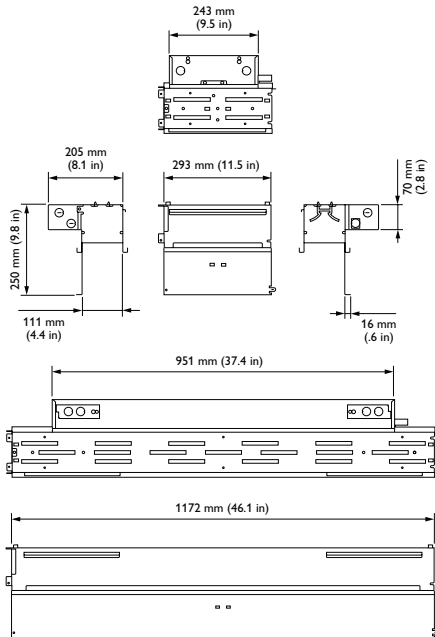

SkyRibbon Wall Grazing Powercore Flangeless Housing, 120 VAC / 277 VAC

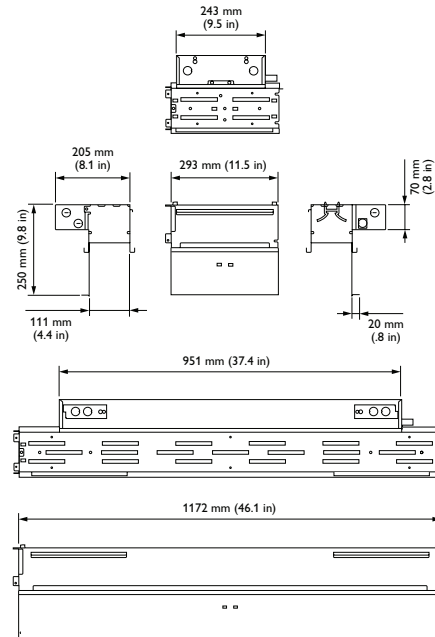

SkyRibbon Wall Grazing Powercore T-Bar / Slotted-T Housing, 120 VAC / 277 VAC

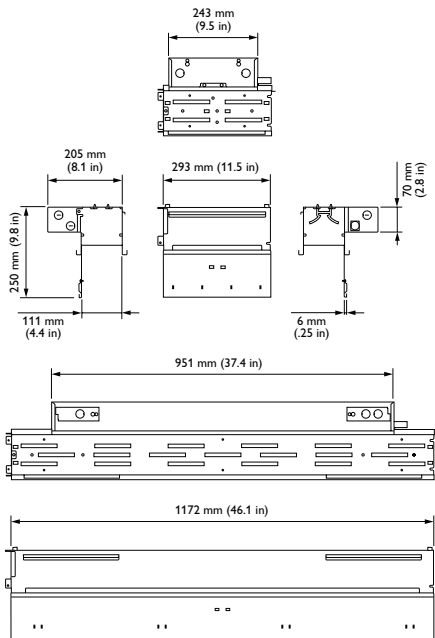

Photometrics / SkyRibbon IntelliHue Wall Grazing Powercore, 10° x 10° native (no spread lens)

Photometric data is based on test results from an independent NIST traceable testing lab. IES data is available at www.philipscolorkinetics.com/support/ies.

RGB channels only, full on

Lumens	Efficacy
522	28.6 lm / W

Polar Candela Distribution

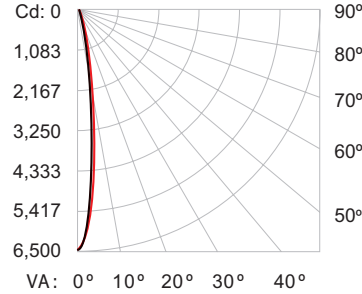

VA: 0°	10°	20°	30°	40°
0	6376	6376	6376	6376
5	3558	3623	3913	4271
15	149	162	193	255
25	67	66	65	60
35	76	73	71	67
45	52	52	51	49
55	37	37	36	33
65	28	27	26	22
75	14	15	16	13
85	12	11	9	5
90	11	10	8	4

Illuminance at Distance

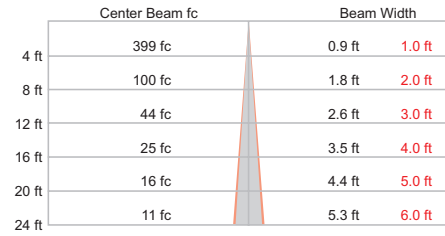

80 ft (24.4 m) 1 fc maximum distance
 Vert. Spread: 12.5°
 Horiz. Spread: 14.2°

Coefficients Of Utilization - Zonal Cavity Method

RCC %:	Effective Floor Cavity Reflectance: 20%											
	80	70	50	30	0	50	30	20	10	0		
RW %:	70	50	30	0	70	50	30	0	50	30	20	0
RCR:	0	119	119	119	119	116	116	116	99	110	110	110
	1	114	111	109	107	111	109	107	94	105	103	101
	2	109	105	102	99	107	103	100	90	100	97	95
	3	106	100	96	93	104	99	95	87	96	93	91
	4	102	96	92	89	100	95	91	84	93	90	87
	5	99	93	88	85	98	92	88	82	90	87	84
	6	97	90	86	82	95	89	85	80	88	84	82
	7	94	88	83	80	93	87	83	78	86	82	80
	8	92	85	81	78	91	85	81	77	84	80	78
	9	90	84	80	77	89	83	79	76	82	78	76
	10	89	82	78	76	88	82	78	75	81	77	75

Zonal Lumen

Zone	Lumens	% Fixture
0 - 60	486.0	93.2 %
60 - 90	28.0	5.4 %
0 - 90	514.0	98.5 %
90 - 180	7.7	1.5 %
0 - 180	521.7	100 %

2700 K

Lumens	Efficacy
823	46.4 lm / W

Polar Candela Distribution

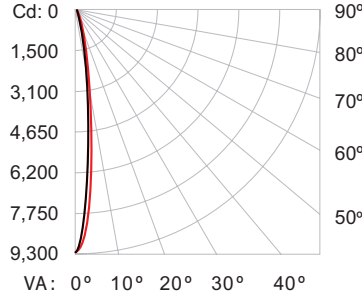

VA: 0°	10°	20°	30°	40°
0	9166	9166	9166	9166
5	4959	5087	5565	6312
15	232	247	309	486
25	107	107	107	100
35	119	117	115	106
45	82	83	83	81
55	59	58	57	54
65	43	42	40	36
75	22	24	25	21
85	18	17	14	8
90	17	16	13	7

Illuminance at Distance

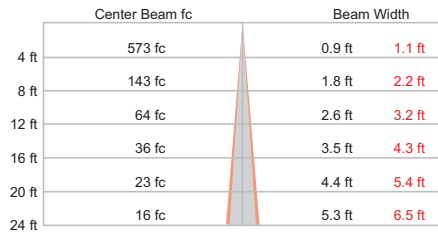

95.7 ft (29.2 m) 1 fc maximum distance
 Vert. Spread: 12.5°
 Horiz. Spread: 15.3°

Coefficients Of Utilization - Zonal Cavity Method

RCC %:	Effective Floor Cavity Reflectance: 20%											
	80	70	50	30	0	50	30	20	10	0		
RW %:	70	50	30	0	70	50	30	0	50	30	20	0
RCR:	0	119	119	119	116	116	116	99	110	110	110	110
	1	114	111	109	107	111	109	107	94	105	103	101
	2	109	105	101	98	107	103	100	90	100	97	95
	3	105	100	96	92	103	98	95	86	96	93	91
	4	102	96	91	88	100	94	90	83	92	89	86
	5	99	92	88	84	97	91	87	81	89	85	82
	6	96	89	85	81	95	88	84	79	87	83	81
	7	93	87	82	79	92	86	82	77	85	81	79
	8	91	84	80	77	90	84	80	76	83	79	77
	9	89	83	78	76	88	82	78	74	81	77	75
	10	88	81	77	74	87	80	77	73	80	76	74

Zonal Lumen

Zone	Lumens	% Fixture
0 - 60	765.2	93.0 %
60 - 90	45.2	5.5 %
0 - 90	810.4	98.5 %
90 - 180	12.2	1.5 %
0 - 180	822.6	100 %

4000 K

Lumens	Efficacy
1141	47.7 lm / W

Polar Candela Distribution

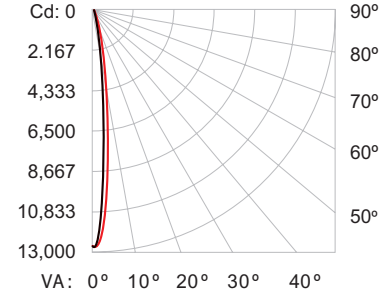

VA: 0°	10°	20°	30°	40°
0	12778	12778	12778	12778
5	6951	7248	7916	8914
15	328	355	456	692
25	148	149	147	139
35	166	162	158	146
45	113	114	115	111
55	82	81	79	74
65	60	59	56	49
75	30	33	34	28
85	25	23	20	11
90	23	21	18	9

Illuminance at Distance

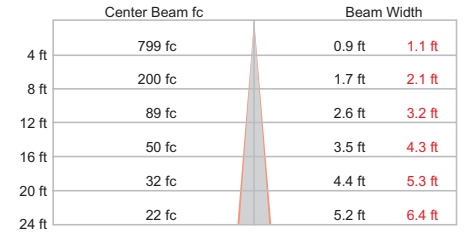

113 ft (34.4 m) 1 fc maximum distance
 Vert. Spread: 12.5°
 Horiz. Spread: 15.2°

Coefficients Of Utilization - Zonal Cavity Method

RCC %:	Effective Floor Cavity Reflectance: 20%											
	80	70	50	30	0	50	30	20	10	0		
RW %:	70	50	30	0	70	50	30	0	50	30	20	0
RCR:	0	119	119	119	116	116	116	99	110	110	110	110
	1	114	111	109	107	111	109	107	94	105	103	101
	2	109	105	101	98	107	103	100	90	100	97	95
	3	105	100	96	92	103	98	95	86	96	93	91
	4	102	96	91	88	100	94	90	83	92	89	86
	5	99	92	88	84	97	91	87	81	89	85	82
	6	96	89	85	81	95	88	84	79	87	83	81
	7	93	87	82	79	92	86	82	77	85	81	79
	8	91	84	80	77	90	84	80	76	83	79	77
	9	89	83	78	76	88	82	78	74	81	77	75
	10	88	81	77	74	87	80	77	73	80	76	74

Zonal Lumen

Zone	Lumens	% Fixture
0 - 60	1061.4	93.0 %
60 - 90	62.4	5.5 %
0 - 90	1123.8	98.5 %
90 - 180	16.9	1.5 %
0 - 180	1140.7	100 %

For lux multiply fc by 10.7

Specifications / SkyRibbon IntelliHue Wall Grazing Powercore, .3 m (1 ft)

Due to continuous improvements and innovations, specifications may change without notice

Item	Specification	RGB channels only, full on	2700 K*	4000 K*
Output	Beam Angle	10° x 10°		
	Lumens†	522	823	1141
	Efficacy (lm / W)	28.6	46.4	47.7
	CRI	—		
	Power Factor	.82 @ 120 VAC	.81 @ 120 VAC	.88 @ 120 VAC
	LED Channels	Red / Green / Blue / Mint White / 4000 K		
	Lumen Maintenance‡	60,000 hours L70 @ 25° C 50,000 hours L70 @ 40° C 100,000 hours L50 @ 25° C 80,000 hours L50 @ 40° C		
Electrical	Input Voltage	120 VAC, 220 — 240 VAC, 277 VAC, 50 / 60 Hz		
	Power Consumption	25 W (0.3 m / 1 ft 120 / 277 VAC) 100 W (1.2 m / 4 ft 120 / 277 VAC) 23 W (0.3 m / 1 ft 220 — 240 VAC) 90 W (1.2 m / 4 ft 220 — 240 VAC)		
Control	Interface	Data Enabler Pro (DMX / Ethernet)		
	Control System	Philips Color Kinetics full range of controllers, including Light System Manager and iPlayer 3, or third-party controllers		
Physical	Housing Material	Steel, white powder-coated finish		
	Lens	Polycarbonate		
	Fixture Connections	178 mm (7 in) flying leads, integral male / female connectors (120 / 277 VAC) Wieland integral male / female connectors (220 — 240 VAC)		
	Temperature Ranges	-20° – 40° C (-4° – 104° F) Operating -20° – 40° C (-4° – 104° F) Startup -40° – 80° C (-40° – 176° F) Storage		
	Fixture Run Lengths	To calculate fixture run lengths and total power consumption for your specific installation, download the Configuration Calculator from www.philipscolorkinetics.com/support/install_tool/		
	Humidity	0 – 95%, non-condensing		
Certification and Safety	Certification	UL / cUL, FCC Class A, CE		
	Environment	Dry / Damp Location, IP20		

* Color temperatures conform to nominal CCTs as defined in ANSI Chromaticity Standard C78.377A.

† Lumen measurement complies with IES LM-79-08 testing procedures.



‡ L70 = 70% lumen maintenance (when light output drops below 70% of initial output).

L50 = 50% lumen maintenance (when light output drops below 50% of initial output). Ambient luminaire temperatures specified. Lumen maintenance calculations are based on lifetime prediction graphs supplied by LED source manufacturers. Calculations for white-light LED fixtures are based on measurements that comply with IES LM-80-08 testing procedures. Refer to www.philipscolorkinetics.com/support/appnotes/lm-80-08.pdf for more information.



Dimensions and Weight

Fixture	Physical Characteristics	T-Bar / Slotted-T	Flanged	Flangeless
.3 m (1 ft)	Housing Dimensions <i>Height x Width x Depth</i>	251 x 293 x 205 mm (9.9 x 11.5 x 8.1 in)	251 x 293 x 205 mm (9.9 x 11.5 x 8.1 in)	251 x 293 x 205 mm (9.9 x 11.5 x 8.1 in)
	Assembled Weight†	3.3 kg (7.3 lbs)	3.3 kg (7.3 lbs)	3.3 kg (7.3 lbs)
1.2 m (4 ft)	Housing Dimensions <i>Height x Width x Depth</i>	251 x 1172 x 205 mm (9.9 x 46.1 x 8.1 in)	251 x 1172 x 205 mm (9.9 x 46.1 x 8.1 in)	251 x 1172 x 205 mm (9.9 x 46.1 x 8.1 in)
	Assembled Weight†	11.4 kg (25.1 lb)	11.4 kg (25.1 lb)	11.4 kg (25.1 lb)

† Assembled weight includes fixture housing and LED module.

Product Selection

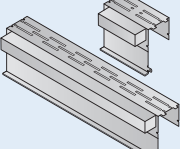
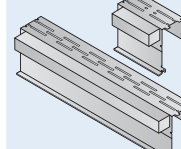
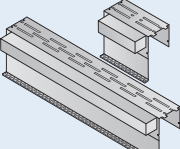
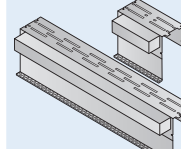
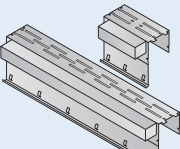
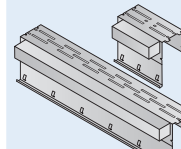
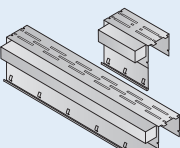
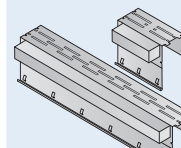
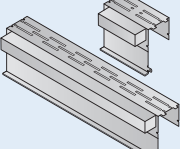
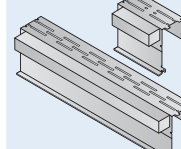
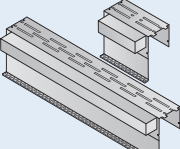
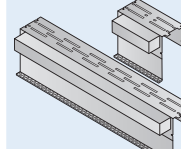
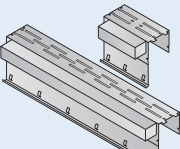
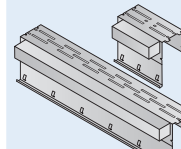
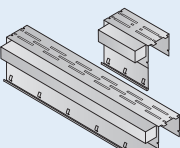
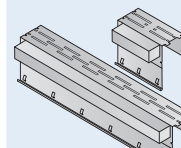
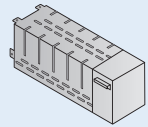
To order a complete SkyRibbon IntelliHue Wall Grazing Powercore fixture, choose a housing (voltage, length, and type), an optional spread lens, an optional accessories..

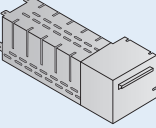
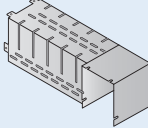
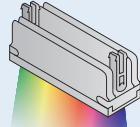
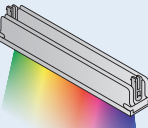
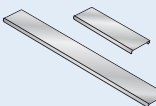
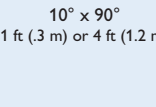
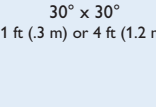
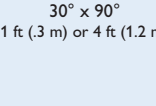
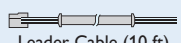
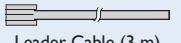
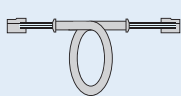
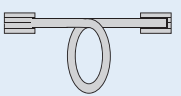
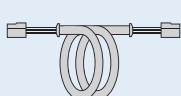
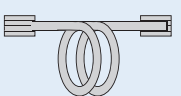
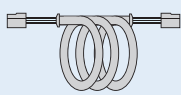
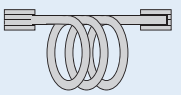
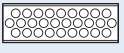
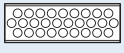
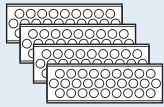
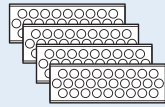
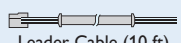
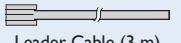
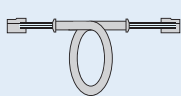
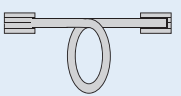
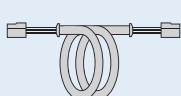
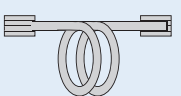
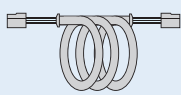
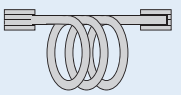
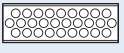
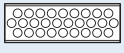
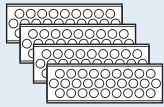
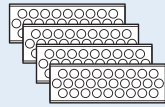
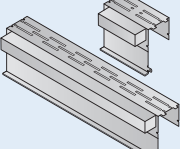
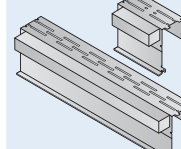
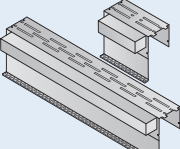
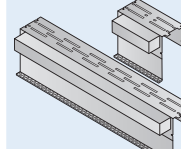
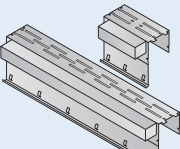
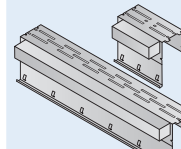
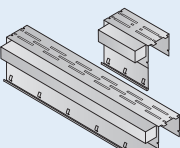
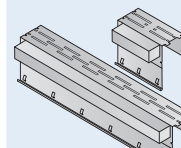
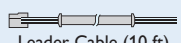
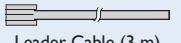
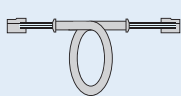
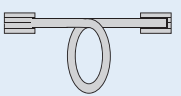
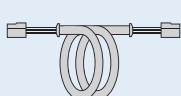
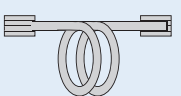
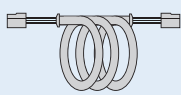
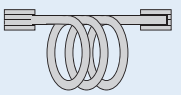
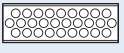
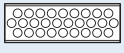
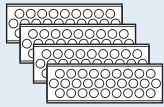
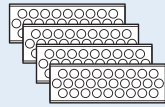
1 Choose housing type	2 Choose terminal housing and optional corners	3 Choose LED Module	4 Choose optional spread lens	5 Choose accessories																								
<table border="0"> <tr> <th data-bbox="138 346 324 378">120 VAC or 277 VAC</th> <th data-bbox="332 346 527 378">220 – 240 VAC</th> </tr> <tr> <td data-bbox="138 388 324 598">  Flanged 1 ft (.3 m) or 4 ft (1.2 m) </td> <td data-bbox="332 388 527 598">  Flanged 1 ft (.3 m) or 4 ft (1.2 m) </td> </tr> <tr> <td data-bbox="138 609 324 819">  Flangeless 1 ft (.3 m) or 4 ft (1.2 m) </td> <td data-bbox="332 609 527 819">  Flangeless 1 ft (.3 m) or 4 ft (1.2 m) </td> </tr> <tr> <td data-bbox="138 829 324 1039">  T-Bar 1 ft (.3 m) or 4 ft (1.2 m) </td> <td data-bbox="332 829 527 1039">  T-Bar 1 ft (.3 m) or 4 ft (1.2 m) </td> </tr> <tr> <td data-bbox="138 1050 324 1260">  Slotted-T 1 ft (.3 m) or 4 ft (1.2 m) </td> <td data-bbox="332 1050 527 1260">  Slotted-T 1 ft (.3 m) or 4 ft (1.2 m) </td> </tr> </table>	120 VAC or 277 VAC	220 – 240 VAC	 Flanged 1 ft (.3 m) or 4 ft (1.2 m)	 Flanged 1 ft (.3 m) or 4 ft (1.2 m)	 Flangeless 1 ft (.3 m) or 4 ft (1.2 m)	 Flangeless 1 ft (.3 m) or 4 ft (1.2 m)	 T-Bar 1 ft (.3 m) or 4 ft (1.2 m)	 T-Bar 1 ft (.3 m) or 4 ft (1.2 m)	 Slotted-T 1 ft (.3 m) or 4 ft (1.2 m)	 Slotted-T 1 ft (.3 m) or 4 ft (1.2 m)	 Terminal  Joiner Plate (to terminate run)  Inside Corner  Outside Corner	 (1 ft / .3 m)  (4 ft / 1.2 m)	 10° x 60° 1 ft (.3 m) or 4 ft (1.2 m)  10° x 90° 1 ft (.3 m) or 4 ft (1.2 m)  30° x 30° 1 ft (.3 m) or 4 ft (1.2 m)  30° x 90° 1 ft (.3 m) or 4 ft (1.2 m)	<table border="0"> <tr> <th data-bbox="1136 346 1331 378">120 VAC / 277 VAC</th> <th data-bbox="1339 346 1526 378">220 – 240 VAC</th> </tr> <tr> <td data-bbox="1136 388 1331 451">  Leader Cable (10 ft) </td> <td data-bbox="1339 388 1526 451">  Leader Cable (3 m) </td> </tr> <tr> <td data-bbox="1136 462 1331 598">  Jumper Cable (1 ft) </td> <td data-bbox="1339 462 1526 598">  Jumper Cable (0.9 m) </td> </tr> <tr> <td data-bbox="1136 609 1331 745">  Jumper Cable (4 ft) </td> <td data-bbox="1339 609 1526 745">  Jumper Cable (1.4 m) </td> </tr> <tr> <td data-bbox="1136 756 1331 892">  Jumper Cable (8 ft) </td> <td data-bbox="1339 756 1526 892">  Jumper Cable (1.7 m) </td> </tr> <tr> <td data-bbox="1136 903 1331 1018">  Louver (1 ft / .3 m) </td> <td data-bbox="1339 903 1526 1018">  Louver (1 ft / .3 m) </td> </tr> <tr> <td data-bbox="1136 1029 1331 1165">  Louver Kit (4 ft / 1.2 m) </td> <td data-bbox="1339 1029 1526 1165">  Louver Kit (4 ft / 1.2 m) </td> </tr> </table>	120 VAC / 277 VAC	220 – 240 VAC	 Leader Cable (10 ft)	 Leader Cable (3 m)	 Jumper Cable (1 ft)	 Jumper Cable (0.9 m)	 Jumper Cable (4 ft)	 Jumper Cable (1.4 m)	 Jumper Cable (8 ft)	 Jumper Cable (1.7 m)	 Louver (1 ft / .3 m)	 Louver (1 ft / .3 m)	 Louver Kit (4 ft / 1.2 m)	 Louver Kit (4 ft / 1.2 m)
120 VAC or 277 VAC	220 – 240 VAC																											
 Flanged 1 ft (.3 m) or 4 ft (1.2 m)	 Flanged 1 ft (.3 m) or 4 ft (1.2 m)																											
 Flangeless 1 ft (.3 m) or 4 ft (1.2 m)	 Flangeless 1 ft (.3 m) or 4 ft (1.2 m)																											
 T-Bar 1 ft (.3 m) or 4 ft (1.2 m)	 T-Bar 1 ft (.3 m) or 4 ft (1.2 m)																											
 Slotted-T 1 ft (.3 m) or 4 ft (1.2 m)	 Slotted-T 1 ft (.3 m) or 4 ft (1.2 m)																											
120 VAC / 277 VAC	220 – 240 VAC																											
 Leader Cable (10 ft)	 Leader Cable (3 m)																											
 Jumper Cable (1 ft)	 Jumper Cable (0.9 m)																											
 Jumper Cable (4 ft)	 Jumper Cable (1.4 m)																											
 Jumper Cable (8 ft)	 Jumper Cable (1.7 m)																											
 Louver (1 ft / .3 m)	 Louver (1 ft / .3 m)																											
 Louver Kit (4 ft / 1.2 m)	 Louver Kit (4 ft / 1.2 m)																											

For 220—240 VAC installations, you must use leader and jumper cables.

For 120 / 277 VAC installations, you can either use leader and jumper cables or hardwire the fixtures. When hardwiring, the fixture acts as a junction box.

Housing and Terminal Options

Item	Style	Length	Voltage	Item Number	Philips 12NC
Housing	Flanged	300 mm	220–240 VAC	172-000073-31	910503704347
		1200 mm	220–240 VAC	172-000073-29	910503704345
		1 ft	120 VAC	172-000073-10	910503704326
			277 VAC	172-000073-22	910503704338
		4 ft	120 VAC	172-000073-07	910503704323
			277 VAC	172-000073-19	910503704335
	Flangeless	300 mm	220–240 VAC	172-000073-42	910503705013
		1200 mm	220–240 VAC	172-000073-44	910503705015
		1 ft	120 VAC	172-000073-11	910503704327
			277 VAC	172-000073-23	910503704339
		4 ft	120 VAC	172-000073-08	910503704324
			277 VAC	172-000073-20	910503704336
	T-Bar / Slotted-T	300 mm	220–240 VAC	172-000073-30	910503704346
		1200 mm	220–240 VAC	172-000073-28	910503704344
		1 ft	120 VAC	172-000073-09	910503704325
			277 VAC	172-000073-21	910503704337
		4 ft	120 VAC	172-000073-06	910503704322
			277 VAC	172-000073-18	910503704334
Inside 90° Corner	Flanged		172-000073-33	910503704357	
	Flangeless		172-000073-34	910503704358	
	T-Bar / Slotted-T		172-000073-32	910503704356	
Outside 90° Corner	Flanged		172-000073-36	910503704360	
	Flangeless		172-000073-37	910503704361	
	T-Bar / Slotted-T		172-000073-35	910503704359	
Terminal Housing	Flanged		172-000073-39	910503704989	
	Flangeless		172-000073-40	910503704990	
	T-Bar / Slotted-T		172-000073-38	910503704988	
Joiner Plate	Compatible with All Housing Versions		172-000073-63	912400133612	

Use Item Number when ordering in North America.

LED Modules, Spread Lenses, and Louvers

Item	Length	Details	Item Number	Philips 12NC
LED Modules	300 mm / 1 ft	IntelliHue	123-000073-00	910503702669
	1200 mm / 4 ft	IntelliHue	123-000073-01	910503702670
Spread lens	300 mm / 1 ft	10° x 60°	120-000173-02	910503704574
	300 mm / 1 ft	10° x 90°	120-000173-01	910503704573
	300 mm / 1 ft	30° x 30°	120-000173-03	910503704575
	300 mm / 1 ft	30° x 60°	120-000173-04	910503704576
	1200 mm / 4 ft	10° x 60°	120-000173-07	910503704579
	1200 mm / 4 ft	10° x 90°	120-000173-14	912400130391
	1200 mm / 4 ft	30° x 30°	120-000173-08	910503704580
	1200 mm / 4 ft	30° x 60°	120-000173-09	910503704581
Louver	300 mm / 1 ft		120-000173-05	910503704577
	1200 mm / 4 ft		120-000173-13	910503705054

Use Item Number when ordering in North America.

Leader and Jumper Cables

Item	Length	Voltage	Item Number	Philips 12NC
Leader Cable	3 m	220–240 VAC	108-000072-14	910503705048
	10 ft	120 / 277 VAC	108-000072-04	910503703985
Jumper Cable	0.9 m	220–240 VAC	108-000072-15	910503705049
	1.4 m	220–240 VAC	108-000072-16	910503705050
	1.7 m	220–240 VAC	108-000072-17	910503705051
	1 ft	120 / 277 VAC	108-000072-00	910503702835
	4 ft	120 / 277 VAC	108-000072-01	910503702836
	8 ft	120 / 277 VAC	108-000072-02	910503702837

Use Item Number when ordering in North America.



Philips Color Kinetics
3 Burlington Woods Drive
Burlington, Massachusetts 01803 USA
Tel 888.385.5742
Tel 617.423.9999
Fax 617.423.9998
www.philipscolorkinetics.com

Copyright © 2013–2015 Philips Solid-State Lighting Solutions, Inc. All rights reserved. Chromacore, Chromasic, CK, the CK logo, Color Kinetics, the Color Kinetics logo, ColorBlast, ColorBlaze, ColorBurst, eW Fuse, ColorGraze, ColorPlay, ColorReach, iW Reach, eW Reach, DIMand, EssentialWhite, eW, iColor; iColor Cove, IntelliWhite, iW, iPlayer, Optibin, and Powercore are either registered trademarks or trademarks of Philips Solid-State Lighting Solutions, Inc. in the United States and / or other countries. All other brand or product names are trademarks or registered trademarks of their respective owners. Due to continuous improvements and innovations, specifications may change without notice. DAS-000124-01 R04 03-15