

Date: _____ Type: _____

Firm Name: _____

Project: _____

SkyRibbon

Essential White Wall Washing Powercore, 4000 K, 65° × 65° spread lens

Recessed linear interior LED wall washing fixture with solid white light

SkyRibbon Essential White Wall Washing Powercore is a recessed linear interior LED wall washing fixture offering high-quality, dimmable solid white light in four color temperatures, ranging from warm 2700 K to cool 4000 K. Brilliant light output and industry-leading color consistency make fixtures ideal for a variety of interior wall-washing applications. Users can rotate LED modules up to 90° to evenly wash walls top to bottom regardless of fixture setback. Multiple housing options accommodate a number of installation methods.

- Four color temperatures — Solid white light LED modules are available in 2700 K, 3000 K, 3500 K, and 4000 K color temperatures, supporting a broad selection of design objectives.
- High-quality illumination in a variety of beam angles — Native 20° × 20° beam angle. Holographic diffusion lenses offer additional 30° × 30°, 30° × 60°, 35° × 105°, 40° × 80°, 65° × 65°, 70° × 95°, and 90° × 90° beam angle options for design flexibility.
- Multiple housing options for installation and mounting flexibility — T-Bar, Slotted-T, Flanged, and Flangeless housings support numerous installation methods and appearances.
- Integrates patented Powercore technology — Powercore rapidly, efficiently, and accurately controls power output to fixtures directly from line voltage, eliminating the need for an external power supply.

- Dimming capability — Patented DIMand technology offers smooth dimming capability with selected commercially available reverse-phase ELV-type dimmers.
- Optibin advanced binning algorithm — Exceeds the recognized standards for color quality to guarantee uniformity and color consistency across LED sources, fixtures, and manufacturing runs.
- Three voltage options — Available 120 VAC, 220 – 240 VAC, and 277 VAC fixtures ensure consistent operation in a number of major international regions.

For detailed product information, please refer to SkyRibbon Essential White Wall Washing Powercore Product Guide at www.philipscolorkinetics.com/ls/ew/skyribbon-wall-washing/

PHILIPS

CE Dimensional Diagrams

SkyRibbon Wall Washing Powercore T-Bar Housing, 220 – 240 VAC

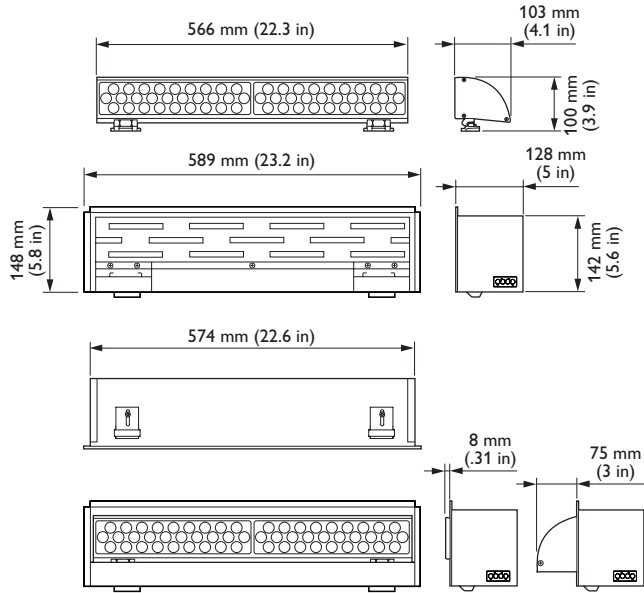

SkyRibbon Wall Washing Powercore Slotted-T Housing, 220 – 240 VAC

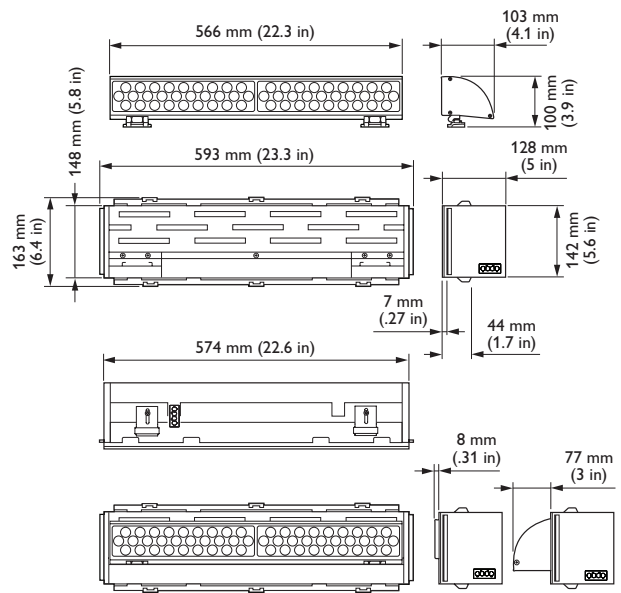

SkyRibbon Wall Washing Powercore Flanged Housing, 220 – 240 VAC

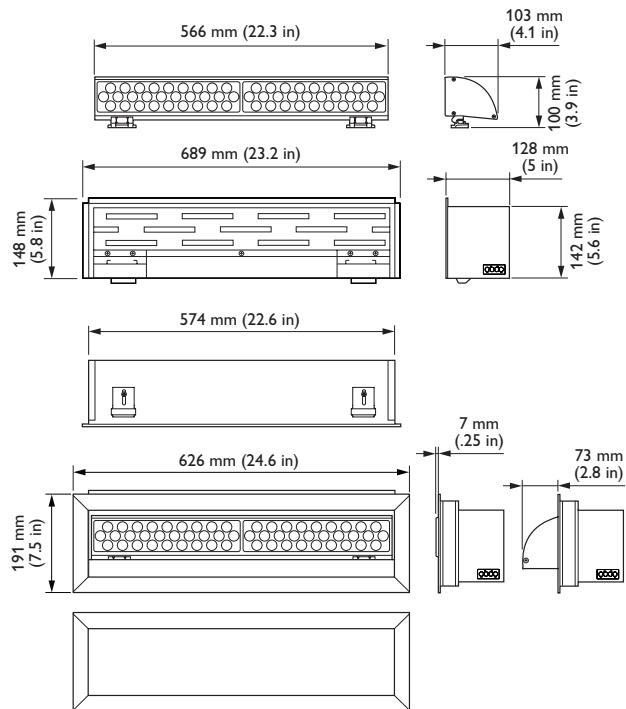

SkyRibbon Wall Washing Powercore Flangeless Housing, 220 – 240 VAC

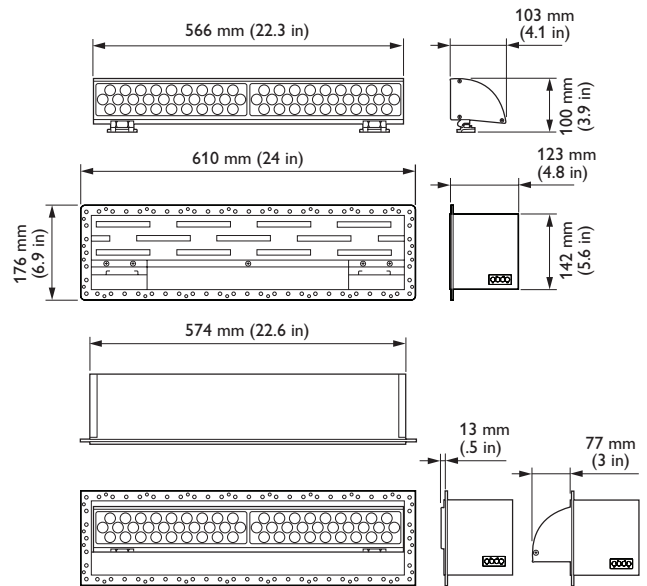

UL Dimensional Diagrams

SkyRibbon Wall Washing Powercore T-Bar Housing, 120 VAC / 277 VAC

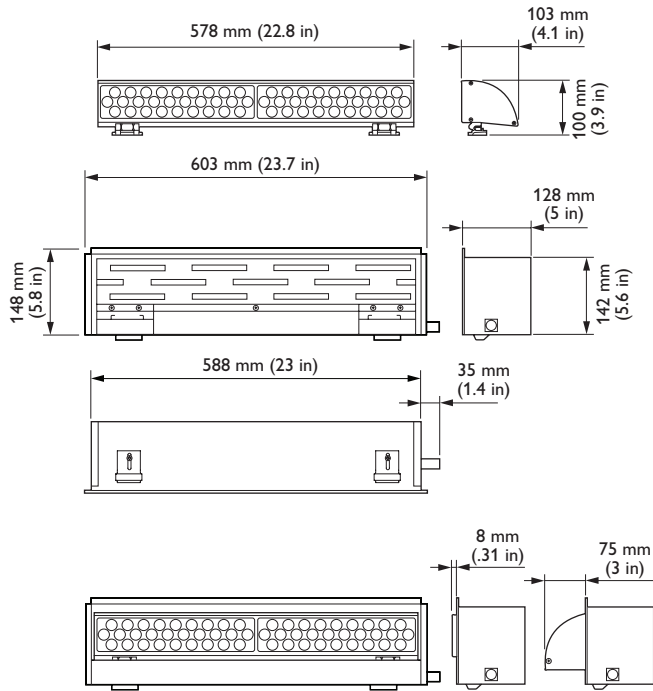

SkyRibbon Wall Washing Powercore Slotted-T Housing, 120 VAC / 277 VAC

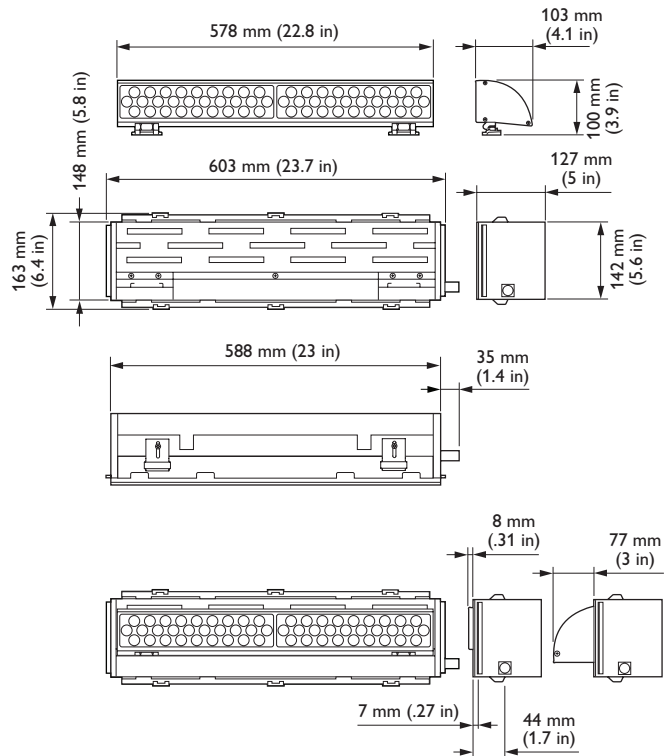

SkyRibbon Wall Washing Powercore Flanged Housing, 120 VAC / 277 VAC

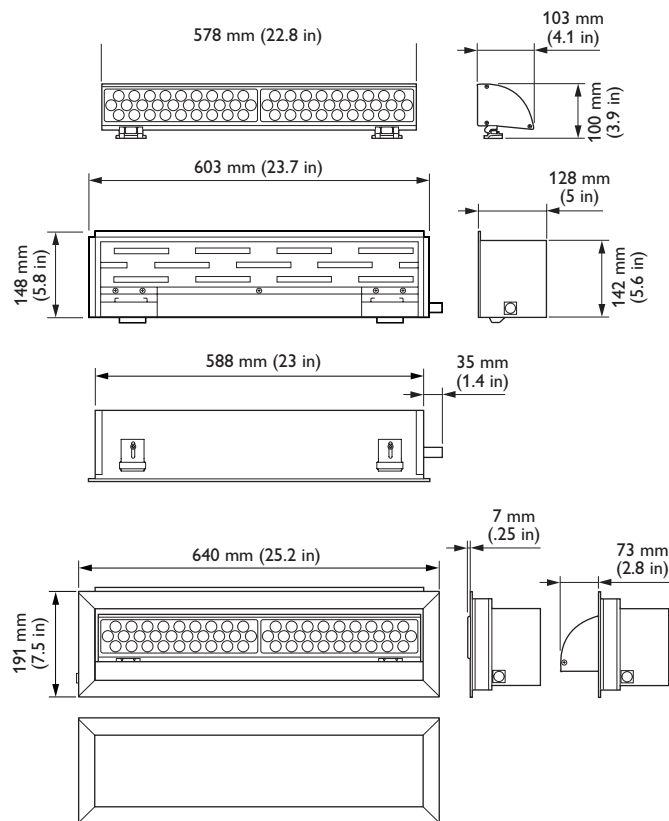

SkyRibbon Wall Washing Powercore Flangeless Housing, 120 VAC / 277 VAC

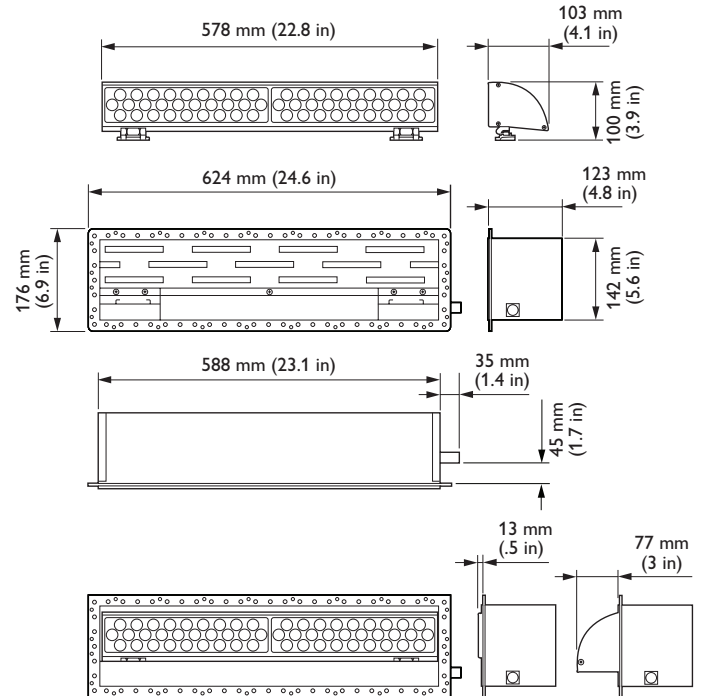

Photometrics / SkyRibbon Essential White Wall Washing Powercore, 4000 K, 65° x 65° spread lens

Photometric data is based on test results from an independent NIST traceable testing lab. IES data is available at www.philipscolorkinetics.com/support/ies.

| Lumens | Efficacy |
|--------|-------------|
| 2907 | 43.5 lm / W |

Polar Candela Distribution

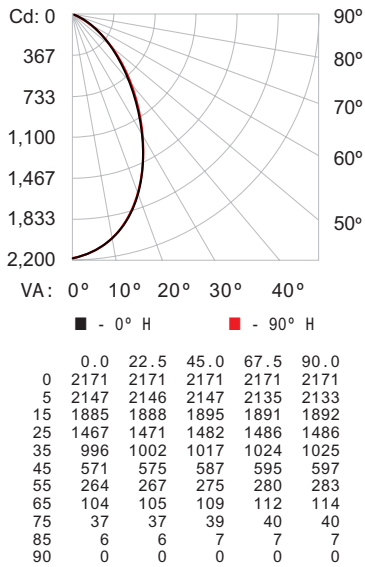

Illuminance at Distance

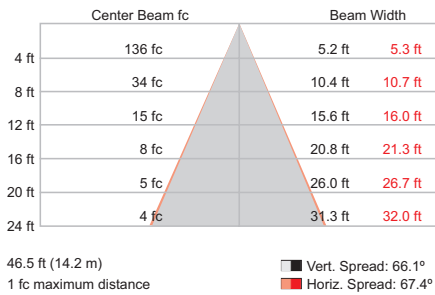

Coefficients Of Utilization - Zonal Cavity Method

Effective Floor Cavity Reflectance: 20%

| RC | 80 | 70 | 50 | 30 | 10 | 0 |
|----|--------------|--------------|--------------|-----------|-----------|-----|
| Rw | 70 50 30 10 | 70 50 30 10 | 50 30 10 | 50 30 10 | 50 30 10 | 0 |
| 0 | 119119119119 | 116116116116 | 111111111111 | 106106106 | 102102102 | 100 |
| 1 | 112108105103 | 109106103101 | 102100 98 | 98 96 95 | 95 93 92 | 90 |
| 2 | 105 98 93 89 | 102 97 92 88 | 93 89 86 | 90 87 84 | 87 85 82 | 81 |
| 3 | 98 89 83 78 | 95 88 82 78 | 85 80 76 | 83 79 75 | 80 77 74 | 72 |
| 4 | 91 82 75 70 | 89 80 74 69 | 78 73 68 | 76 71 67 | 74 70 67 | 65 |
| 5 | 85 75 68 62 | 83 74 67 62 | 72 66 62 | 70 65 61 | 68 64 60 | 59 |
| 6 | 80 69 62 56 | 78 68 61 56 | 66 60 56 | 65 60 55 | 64 59 55 | 53 |
| 7 | 75 64 56 51 | 73 63 56 51 | 62 55 51 | 60 55 51 | 59 54 50 | 49 |
| 8 | 71 59 52 47 | 69 59 52 47 | 57 51 47 | 56 51 47 | 55 50 46 | 45 |
| 9 | 67 55 48 43 | 65 55 48 43 | 54 47 43 | 53 47 43 | 52 47 43 | 41 |
| 10 | 63 52 45 40 | 62 51 44 40 | 50 44 40 | 49 44 40 | 48 43 40 | 38 |

Zonal Lumen

| ZONE | LUMENS | %FIXT |
|----------|--------|-------|
| 0 - 30 | 1407 | 48.4 |
| 0 - 40 | 2039 | 70.2 |
| 0 - 60 | 2743 | 94.4 |
| 0 - 90 | 2907 | 100.0 |
| 90 - 180 | 0 | 0.0 |
| 0 - 180 | 2907 | 100.0 |

For lux multiply fc by 10.7

Specifications / SkyRibbon Essential White Wall Washing Powercore, 4000 K, 65° x 65° spread lens

Due to continuous improvements and innovations, specifications may change without notice

| Item | Specification | Details |
|--------------------------|---------------------|--|
| Output | Lumens* | 2907 |
| | Efficacy (lm / W) | 43.5 |
| | CRI | 85 |
| | Power Factor | .992 @ 120 VAC |
| | Color Temperature† | 4000 K |
| | Lumen Maintenance‡ | 76,000 hours L70 @ 25° C 50,000 hours L70 @ 40° C 100,000 hours L50 @ 25° C 80,000 hours L50 @ 40° C |
| Electrical | Input Voltage | 120 VAC, 220 – 240 VAC, 277 VAC, 50 / 60 Hz |
| | Power Consumption | 70 W maximum at full output, steady state |
| Control | Dimming | Compatible with selected commercially available reverse-phase ELV-type dimmers§ |
| Physical | Housing Material | Steel, white powder-coated finish |
| | Lens | Polycarbonate |
| | Fixture Connections | 7 in (178 mm) flying leads, integral male / female connectors (120 / 277 VAC) Wieland integral male / female connectors (220 – 240 VAC) |
| | Temperature Ranges | -4° – 104° F (-20° – 40° C) Operating -4° – 104° F (-20° – 40° C) Startup -40° – 176° F (-40° – 80° C) Storage |
| | Fixture Run Lengths | To calculate fixture run lengths and total power consumption for your specific installation, download the Configuration Calculator from www.philipscolorkinetics.com/support/install_tool/ |
| | Humidity | 0 – 95%, non-condensing |
| Certification and Safety | Certification | UL / cUL, CE, FCC Class A |
| | Environment | Dry / Damp Location, IP20 |

* Lumen measurement complies with IES LM-79-08 testing procedures.

† Color temperatures conform to nominal CCTs as defined in ANSI Chromaticity Standard C78.377A.



‡ L70 = 70% lumen maintenance (when light output drops below 70% of initial output).

L50 = 50% lumen maintenance (when light output drops below 50% of initial output). Ambient luminaire temperatures specified. Lumen maintenance calculations are based on lifetime prediction graphs supplied by LED source manufacturers. Calculations for white-light LED fixtures are based on measurements that comply with IES LM-80-08 testing procedures. Refer to www.philipscolorkinetics.com/support/appnotes/lm-80-08.pdf for more information.

§ Refer to www.philipscolorkinetics.com/support/appnotes/ for specific details.

Dimensions and Weight

| Fixture | | Flanged | Flangeless | T-Bar | Slotted-T |
|-------------------|--|--------------------|---------------------|--------------------|--------------------|
| 120 VAC / 277 VAC | Housing Dimensions (Height x Width x Depth) | 5.8 x 23.7 x 5 in | 6.9 x 24.6 x 4.8 in | 5.8 x 23.7 x 5 in | 6.4 x 23.7 x 5 in |
| | Assembled Weight† | 10.4 lbs | 8.6 lbs | 8.6 lbs | 8.6 lbs |
| 220 – 240 VAC | Housing Dimensions (Height x Width x Depth) | 148 x 689 x 128 mm | 176 x 610 x 123 mm | 148 x 589 x 128 mm | 163 x 593 x 128 mm |
| | Assembled Weight† | 4.7 kg | 3.9 kg | 3.9 kg | 3.9 kg |

† Assembled weight includes fixture housing and LED module.



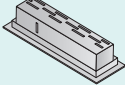
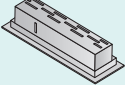
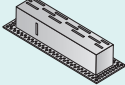
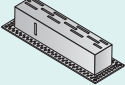
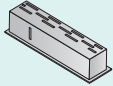
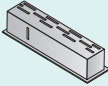
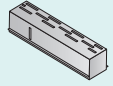
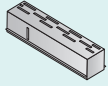

Product Selection

To order a complete SkyRibbon Essential White Wall Washing Powercore fixture, choose a housing (voltage, length, and type), an LED module, a spread lens, a Leader Cable, and optional Jumper Cables and louvers.

1 Choose housing type

| 120 VAC or 277 VAC | 220 – 240 VAC |
|--|--|
|  Flanged (2 ft) |  Flanged (600 mm) |
|  Flangeless (2 ft) |  Flangeless (600 mm) |
|  T-Bar (2 ft) |  T-Bar (600 mm) |
|  Slot-T (2 ft) |  Slot-T (600 mm) |

2 Choose LED module

 2700 K
2 ft or 600 mm
 3000 K
2 ft or 600 mm
 3500 K
2 ft or 600 mm
 4000 K
2 ft or 600 mm

3 Choose optional spread lens

30° x 30°

30° x 60°

35° x 105°



40° x 80°

65° x 65°

70° x 95°

90° x 90°

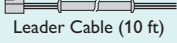
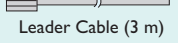
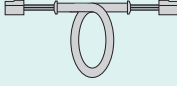
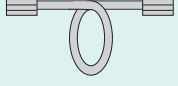
4 Choose accessories

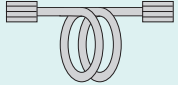
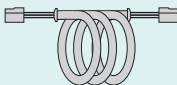
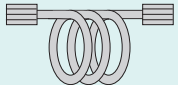
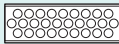
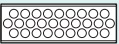
| 120 VAC / 277 VAC | 220 – 240 VAC |
|---|---|
|  Leader Cable (10 ft) |  Leader Cable (3 m) |
|  Jumper Cable (1 ft) |  Jumper Cable (0.9 m) |
|  Jumper Cable (4 ft) |  Jumper Cable (1.4 m) |
|  Jumper Cable (8 ft) |  Jumper Cable (1.7 m) |
|  Louver (2 ft) |  Louver (600 mm) |

2 ft / 120 VAC or 277 VAC

| Item | Voltage | Type | Item Number | Philips 12NC |
|----------|---------|------------------------------|---------------------------------|--------------------------------|
| Housings | 120 VAC | T-Bar | 172-000072-00 | 910503703213 |
| | | Slotted-T | 172-000072-12 | 910503704284 |
| | | Flanged (fixture and flange) | 172-000072-00 and 120-000172-14 | 910503703213 and 120-000172-09 |
| | | Flangeless | 172-000072-01 | 910503703214 |
| | 277 VAC | T-Bar | 172-000072-04 | 910503704245 |
| | | Slotted-T | 172-000072-14 | 910503704245 |
| | | Flanged (fixture and flange) | 172-000072-04 and 120-000172-14 | 910503704245 and 120-000172-09 |
| | | Flangeless | 172-000072-05 | 910503704246 |

| Item | Color Temperature | Item Number | Philips 12NC |
|-------------|-------------------|---------------|--------------|
| LED Modules | 2700 K | 523-000072-00 | 910503702648 |
| | 3000 K | 523-000072-01 | 910503702649 |
| | 3500 K | 523-000072-02 | 910503702650 |
| | 4000 K | 523-000072-03 | 910503702651 |

| Item | Beam Angle | Item Number | Philips 12NC |
|---------------|------------|---------------|--------------|
| Spread Lenses | 30° x 30° | 120-000172-01 | 910503702691 |
| | 30° x 60° | 120-000172-02 | 910503702692 |
| | 35° x 105° | 120-000172-03 | 910503702693 |
| | 40° x 80° | 120-000172-04 | 910503702694 |
| | 65° x 65° | 120-000172-06 | 910503702696 |
| | 70° x 95° | 120-000172-07 | 910503702697 |
| | 90° x 90° | 120-000172-08 | 910503702698 |

Use Item Number when ordering in North America.

Product Selection (continued)

| Item | | Length | Item Number | Philips 12NC |
|------------------------------|--------------|--------|---------------|--------------|
| Leader Cable and Accessories | Leader Cable | 10 ft | 108-000072-03 | 910503703135 |
| | Jumper Cable | 1 ft | 108-000072-00 | 910503702835 |
| | | 4 ft | 108-000072-01 | 910503702836 |
| | | 8 ft | 108-000072-02 | 910503702837 |
| | Louver | | 120-000172-00 | 910503702690 |

Use Item Number when ordering in North America.

600 mm / 220 – 240 VAC

| Item | Type | Item Number | Philips 12NC |
|----------|---------------------------------|------------------------------------|----------------------------------|
| Housings | T-Bar | 172-000072-08 | 910503704262 |
| | Slotted-T | 172-000072-16 | 910503704631 |
| | Flanged (fixture and flange) | 172-000072-08 and 120-000172-10 | 910503704263 and 910503704271 |
| | | Flangeless | 172-000072-18 |

| Item | Color Temperature | Item Number | Philips 12NC |
|-------------|-------------------|---------------|--------------|
| LED Modules | 2700 K | 523-000072-04 | 910503704258 |
| | 3000 K | 523-000072-05 | 910503704259 |
| | 3500 K | 523-000072-06 | 910503704260 |
| | 4000 K | 523-000072-07 | 910503704261 |

| Item | Beam Angle | Item Number | Philips 12NC |
|---------------|------------|---------------|--------------|
| Spread Lenses | 30° x 30° | 120-000161-01 | 910503704213 |
| | 30° x 60° | 120-000161-02 | 910503704214 |
| | 35° x 105° | 120-000161-03 | 910503704215 |
| | 40° x 80° | 120-000161-04 | 910503704216 |
| | 65° x 65° | 120-000161-06 | 910503704218 |
| | 70° x 95° | 120-000161-07 | 910503704219 |
| | 90° x 90° | 120-000161-08 | 910503704220 |

| Item | | Length | Item Number | Philips 12NC |
|------------------------------|--------------|--------|---------------|--------------|
| Leader Cable and Accessories | Leader Cable | 3 m | 108-000072-13 | 910503705047 |
| | Jumper Cable | 0.9 m | 108-000072-15 | 910503705049 |
| | | 1.4 m | 108-000072-16 | 910503705050 |
| | | 1.7 m | 108-000072-17 | 910503705051 |
| | Louver | | 120-000161-00 | 910503704249 |

Use Item Number when ordering in North America.



Philips Color Kinetics
 3 Burlington Woods Drive
 Burlington, Massachusetts 01803 USA
 Tel 888.385.5472
 Tel 617.423.9999
 Fax 617.423.9998
www.philipscolorkinetics.com

Copyright © 2013–2015 Philips Solid-State Lighting Solutions, Inc. All rights reserved. Chromacore, Chromasic, CK, the CK logo, Color Kinetics, the Color Kinetics logo, ColorBlast, ColorBlaze, ColorBurst, eW Fuse, ColorGraze, ColorPlay, ColorReach, iW Reach, eW Reach, DIMand, EssentialWhite, eW, iColor; iColor Cove, IntelliWhite, iW, iPlayer, Optibin, and Powercore are either registered trademarks or trademarks of Philips Solid-State Lighting Solutions, Inc. in the United States and / or other countries. All other brand or product names are trademarks or registered trademarks of their respective owners. Due to continuous improvements and innovations, specifications may change without notice.

DAS-000122-18 R03 04-15