



Date: _____ Type: _____

Firm Name: _____

Project: _____

SkyRibbon

Essential White Wall Washing Powercore, 2700 K, 90° × 90° spread lens

Recessed linear interior LED wall washing fixture with solid white light

SkyRibbon Essential White Wall Washing Powercore is a recessed linear interior LED wall washing fixture offering high-quality, dimmable solid white light in four color temperatures, ranging from warm 2700 K to cool 4000 K. Brilliant light output and industry-leading color consistency make fixtures ideal for a variety of interior wall-washing applications. Users can rotate LED modules up to 90° to evenly wash walls top to bottom regardless of fixture setback. Multiple housing options accommodate a number of installation methods.

- Four color temperatures — Solid white light LED modules are available in 2700 K, 3000 K, 3500 K, and 4000 K color temperatures, supporting a broad selection of design objectives.
- High-quality illumination in a variety of beam angles — Native 20° × 20° beam angle. Holographic diffusion lenses offer additional 30° × 30°, 30° × 60°, 35° × 105°, 40° × 80°, 65° × 65°, 70° × 95°, and 90° × 90° beam angle options for design flexibility.
- Multiple housing options for installation and mounting flexibility — T-Bar, Slotted-T, Flanged, and Flangeless housings support numerous installation methods and appearances.
- Integrates patented Powercore technology — Powercore rapidly, efficiently, and accurately controls power output to fixtures directly from line voltage, eliminating the need for an

external power supply.

- Dimming capability — Patented DIMand technology offers smooth dimming capability with selected commercially available reverse-phase ELV-type dimmers.
- Optibin advanced binning algorithm — Exceeds the recognized standards for color quality to guarantee uniformity and color consistency across LED sources, fixtures, and manufacturing runs.
- Three voltage options — Available 120 VAC, 220 – 240 VAC, and 277 VAC fixtures ensure consistent operation in a number of major international regions.

For detailed product information, please refer to SkyRibbon Essential White Wall Washing Powercore Product Guide at www.philipscolorkinetics.com/ls/ew/skyribbon-wall-washing/

PHILIPS

CE Dimensional Diagrams

SkyRibbon Wall Washing Powercore T-Bar Housing, 220 – 240 VAC

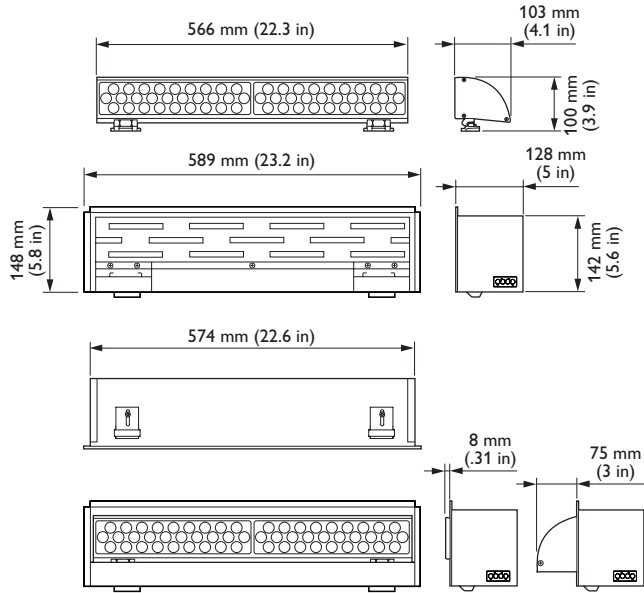

SkyRibbon Wall Washing Powercore Slotted-T Housing, 220 – 240 VAC

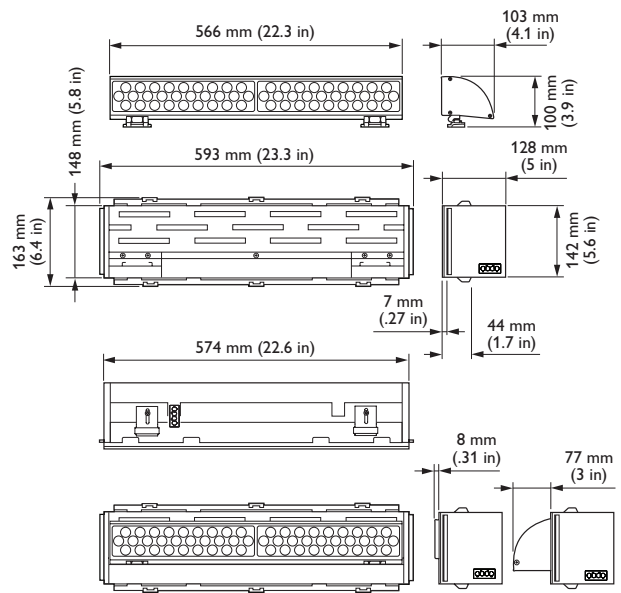

SkyRibbon Wall Washing Powercore Flanged Housing, 220 – 240 VAC

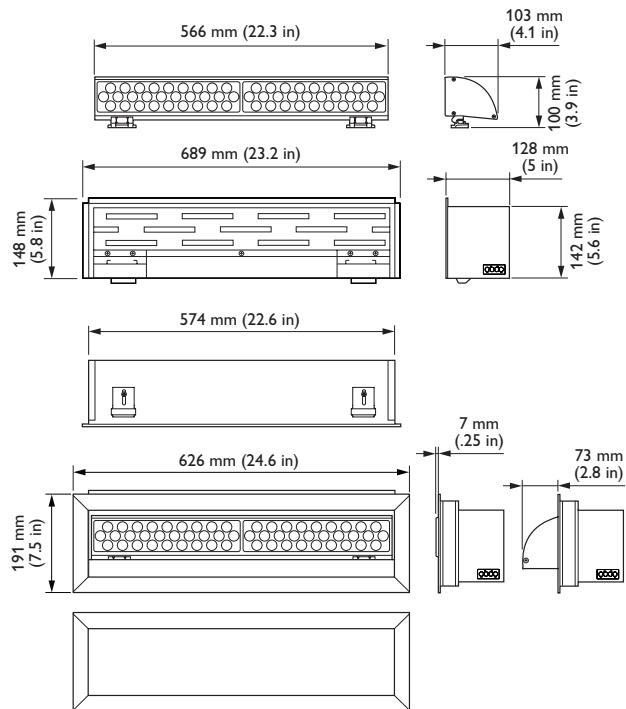

SkyRibbon Wall Washing Powercore Flangeless Housing, 220 – 240 VAC

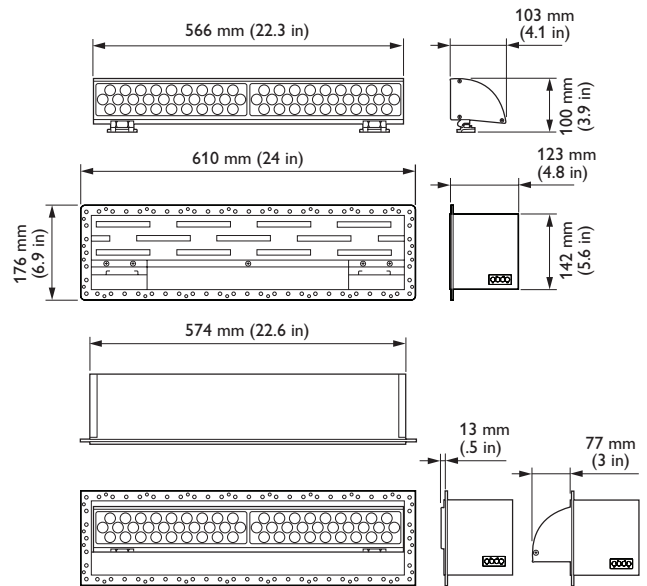

UL Dimensional Diagrams

SkyRibbon Wall Washing Powercore T-Bar Housing, 120 VAC / 277 VAC

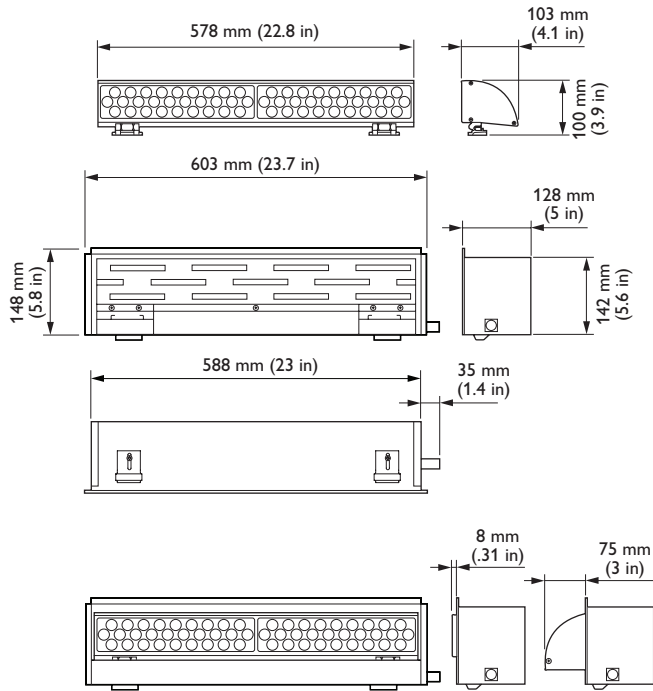

SkyRibbon Wall Washing Powercore Slotted-T Housing, 120 VAC / 277 VAC

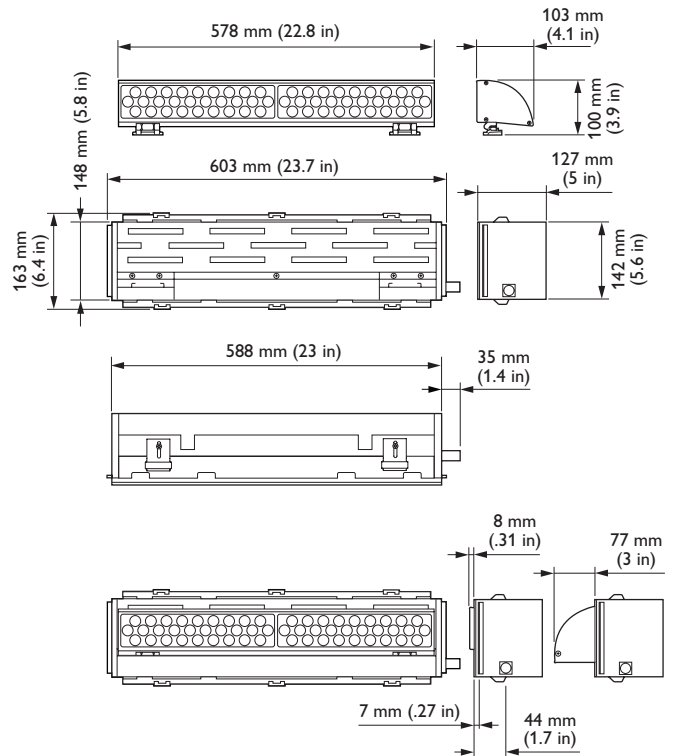

SkyRibbon Wall Washing Powercore Flanged Housing, 120 VAC / 277 VAC

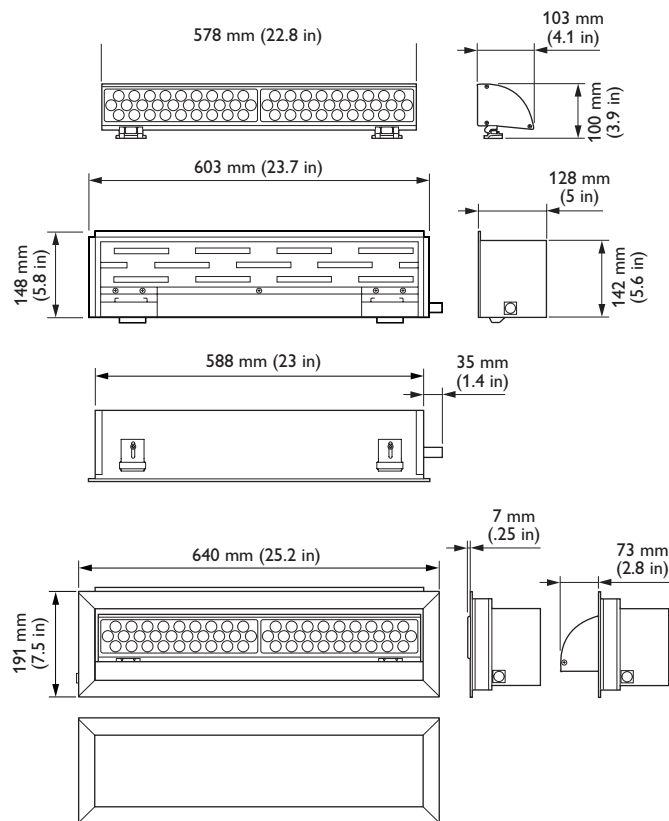

SkyRibbon Wall Washing Powercore Flangeless Housing, 120 VAC / 277 VAC

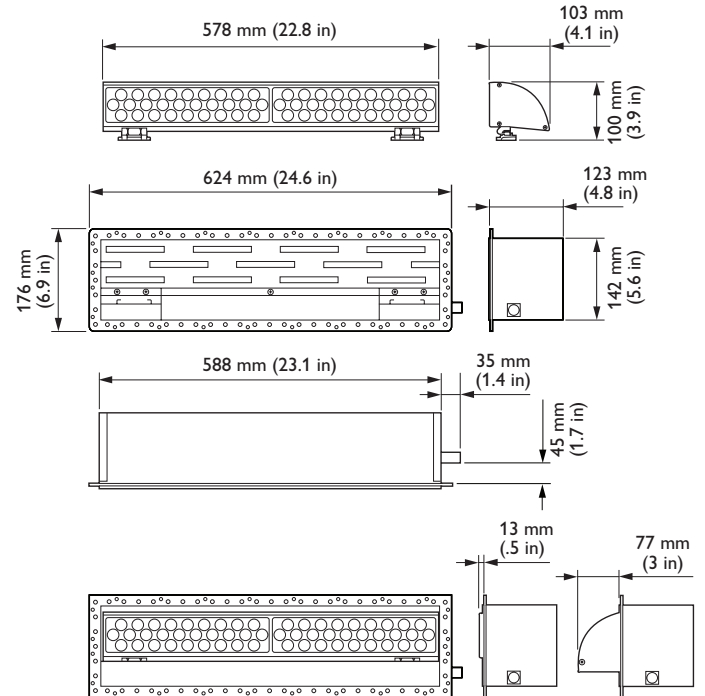

Photometrics / SkyRibbon Essential White Wall Washing Powercore, 2700 K, 90° x 90° spread lens

Photometric data is based on test results from an independent NIST traceable testing lab. IES data is available at www.philipscolorkinetics.com/support/ies.

Lumens	Efficacy
2135	34.2 lm / W

Polar Candela Distribution

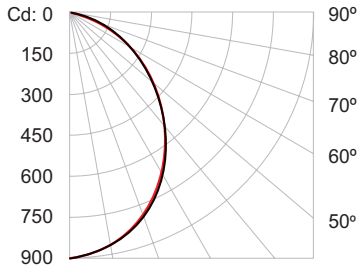

VA: 0° 10° 20° 30° 40°

■ - 0° H ■ - 90° H

	0.0	22.5	45.0	67.5	90.0
0	896	896	896	896	896
5	894	892	892	888	887
15	842	840	838	834	832
25	746	744	741	736	731
35	624	622	619	614	610
45	494	492	489	485	482
55	364	363	361	358	355
65	239	238	236	235	234
75	119	119	119	119	118
85	21	21	22	22	22
90	0	0	0	0	0

Illuminance at Distance

	Center Beam fc	Beam Width
4 ft	56 fc	9.0 ft 8.8 ft
8 ft	14 fc	18.1 ft 16.6 ft
12 ft	6 fc	27.1 ft 26.3 ft
16 ft	4 fc	36.2 ft 35.1 ft
20 ft	2 fc	45.2 ft 43.9 ft
24 ft	2 fc	54.2 ft 52.7 ft

30 ft (9.1 m) ■ Vert. Spread: 97°
 1 fc maximum distance ■ Horiz. Spread: 95.3°

Coefficients Of Utilization - Zonal Cavity Method

Effective Floor Cavity Reflectance: 20%

RC	80	70	50	30	10	0
Rw	70 50 30 10	70 50 30 10	50 30 10	50 30 10	50 30 10	0
0	119119119119	116116116116	1111111111	106106106	102102102	100
1	109105101 97	107103 99 96	98 95 93	94 92 90	91 89 87	85
2	100 92 85 80	97 90 84 79	87 82 77	83 79 75	80 77 74	72
3	91 81 73 67	89 80 72 67	77 70 65	74 69 64	71 67 63	61
4	84 72 64 57	82 71 63 57	69 62 56	66 60 55	64 59 55	53
5	77 65 56 50	75 64 56 50	62 55 49	60 53 48	58 52 48	46
6	72 59 50 44	70 58 50 44	56 49 43	54 48 43	53 47 42	40
7	67 53 45 39	65 53 44 39	51 44 38	50 43 38	48 42 38	36
8	62 49 41 35	61 48 40 35	47 40 35	46 39 34	44 39 34	32
9	58 45 37 32	57 44 37 31	43 36 31	42 36 31	41 35 31	29
10	55 42 34 29	53 41 34 29	40 33 29	39 33 28	38 32 28	27

Zonal Lumen

ZONE	LUMENS	%FIXT
0- 30	660	30.9
0- 40	1047	49.0
0- 60	1746	81.8
0- 90	2135	100.0
90-180	0	0.0
0-180	2135	100.0

For lux multiply fc by 10.7

Specifications / SkyRibbon Essential White Wall Washing Powercore, 2700 K, 90° x 90° spread lens

Due to continuous improvements and innovations, specifications may change without notice

Item	Specification	Details
Output	Lumens*	2135
	Efficacy (lm / W)	34.2
	CRI	84
	Power Factor	.99 @ 120 VAC
	Color Temperature†	2700 K
	Lumen Maintenance‡	76,000 hours L70 @ 25° C 50,000 hours L70 @ 40° C 100,000 hours L50 @ 25° C 80,000 hours L50 @ 40° C
Electrical	Input Voltage	120 VAC, 220 – 240 VAC, 277 VAC, 50 / 60 Hz
	Power Consumption	70 W maximum at full output, steady state
Control	Dimming	Compatible with selected commercially available reverse-phase ELV-type dimmers§
Physical	Housing Material	Steel, white powder-coated finish
	Lens	Polycarbonate
	Fixture Connections	7 in (178 mm) flying leads, integral male / female connectors (120 / 277 VAC) Wieland integral male / female connectors (220 – 240 VAC)
	Temperature Ranges	-4° – 104° F (-20° – 40° C) Operating -4° – 104° F (-20° – 40° C) Startup -40° – 176° F (-40° – 80° C) Storage
	Fixture Run Lengths	To calculate fixture run lengths and total power consumption for your specific installation, download the Configuration Calculator from www.philipscolorkinetics.com/support/install_tool/
	Humidity	0 – 95%, non-condensing
Certification and Safety	Certification	UL / cUL, CE, FCC Class A
	Environment	Dry / Damp Location, IP20

* Lumen measurement complies with IES LM-79-08 testing procedures.

† Color temperatures conform to nominal CCTs as defined in ANSI Chromaticity Standard C78.377A.

‡ L70 = 70% lumen maintenance (when light output drops below 70% of initial output).

L50 = 50% lumen maintenance (when light output drops below 50% of initial output). Ambient luminaire temperatures specified. Lumen maintenance calculations are based on lifetime prediction graphs supplied by LED source manufacturers. Calculations for white-light LED fixtures are based on measurements that comply with IES LM-80-08 testing procedures. Refer to www.philipscolorkinetics.com/support/appnotes/lm-80-08.pdf for more information.

§ Refer to www.philipscolorkinetics.com/support/appnotes/ for specific details.







Dimensions and Weight

Fixture		Flanged	Flangeless	T-Bar	Slotted-T
120 VAC / 277 VAC	Housing Dimensions (Height x Width x Depth)	5.8 x 23.7 x 5 in	6.9 x 24.6 x 4.8 in	5.8 x 23.7 x 5 in	6.4 x 23.7 x 5 in
	Assembled Weight†	10.4 lbs	8.6 lbs	8.6 lbs	8.6 lbs
220 – 240 VAC	Housing Dimensions (Height x Width x Depth)	148 x 689 x 128 mm	176 x 610 x 123 mm	148 x 589 x 128 mm	163 x 593 x 128 mm
	Assembled Weight†	4.7 kg	3.9 kg	3.9 kg	3.9 kg

† Assembled weight includes fixture housing and LED module.

Product Selection

To order a complete SkyRibbon Essential White Wall Washing Powercore fixture, choose a housing (voltage, length, and type), an LED module, a spread lens, a Leader Cable, and optional Jumper Cables and louvers.

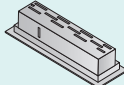
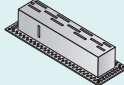
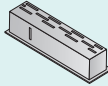
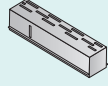
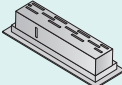
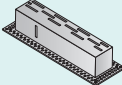
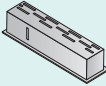
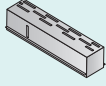
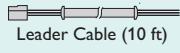
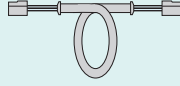
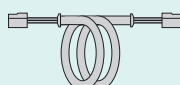
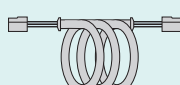
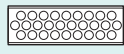
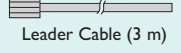
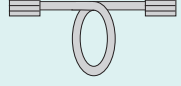
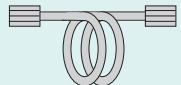
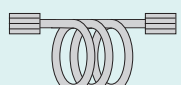
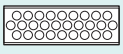
1 Choose housing type		2 Choose LED module		3 Choose optional spread lens		4 Choose accessories					
120 VAC or 277 VAC		220 – 240 VAC		 <p>2700 K 2 ft or 600 mm</p>  <p>3000 K 2 ft or 600 mm</p>  <p>3500 K 2 ft or 600 mm</p>  <p>4000 K 2 ft or 600 mm</p>		<p>30° x 30°</p> <p>30° x 60°</p> <p>35° x 105°</p> <p>40° x 80°</p> <p>65° x 65°</p> <p>70° x 95°</p> <p>90° x 90°</p>		120 VAC / 277 VAC		220 – 240 VAC	
 <p>Flanged (2 ft)</p>  <p>Flangeless (2 ft)</p>  <p>T-Bar (2 ft)</p>  <p>Slot-T (2 ft)</p>		 <p>Flanged (600 mm)</p>  <p>Flangeless (600 mm)</p>  <p>T-Bar (600 mm)</p>  <p>Slot-T (600 mm)</p>				 <p>Leader Cable (10 ft)</p>  <p>Jumper Cable (1 ft)</p>  <p>Jumper Cable (4 ft)</p>  <p>Jumper Cable (8 ft)</p>  <p>Louver (2 ft)</p>		 <p>Leader Cable (3 m)</p>  <p>Jumper Cable (0.9 m)</p>  <p>Jumper Cable (1.4 m)</p>  <p>Jumper Cable (1.7 m)</p>  <p>Louver (600 m)</p>			

For 220—240 VAC installations, you must use leader and jumper cables.

For 120 / 277 VAC installations, you can either use leader and jumper cables or hardwire the fixtures. When hardwiring, the fixture acts as a junction box.

Product Selection (continued)

2 ft / 120 VAC or 277 VAC

Item	Voltage	Type	Item Number	Philips 12NC
Housings 120 / 277 VAC	120 VAC	T-Bar	172-000072-00	910503703213
		Slotted-T	172-000072-12	910503704284
		Flanged (fixture and flange)	172-000072-00 and 120-000172-09	910503703213 and 910503703274
		Flangeless	172-000072-01	910503703214
	277 VAC	T-Bar	172-000072-04	910503704245
		Slotted-T	172-000072-14	910503704286
		Flanged (fixture and flange)	172-000072-04 and 120-000172-09	910503704245 and 910503703274
		Flangeless	172-000072-05	910503704246

Item	Color Temperature	Item Number	Philips 12NC
LED Modules 120 / 277 VAC	2700 K	523-000072-00	910503702648
	3000 K	523-000072-01	910503702649
	3500 K	523-000072-02	910503702650
	4000 K	523-000072-03	910503702651

Item	Beam Angle	Item Number	Philips 12NC
Spread Lenses 120 / 277 VAC	30° x 30°	120-000172-01	910503702691
	30° x 60°	120-000172-02	910503702692
	35° x 105°	120-000172-03	910503702693
	40° x 80°	120-000172-04	910503702694
	65° x 65°	120-000172-06	910503702696
	70° x 95°	120-000172-07	910503702697
	90° x 90°	120-000172-08	910503702698

Use Item Number when ordering in North America.

Product Selection (continued)

Item		Length	Item Number	Philips 12NC
Leader Cable and Accessories	Leader Cable	10 ft	108-000072-03	910503703135
	Jumper Cable	1 ft	108-000072-00	910503702835
		4 ft	108-000072-01	910503702836
		8 ft	108-000072-02	910503702837
	Louver		120-000172-00	910503702690

Use Item Number when ordering in North America.

600 mm / 220 – 240 VAC

Item	Type	Item Number	Philips 12NC
Housings	T-Bar	172-000072-08	910503704262
	Slotted-T	172-000072-16	910503704631
	Flanged (fixture and flange)	172-000072-08 and 120-000172-10	910503704263 and 910503704271
		Flangeless	172-000072-18

Item	Color Temperature	Item Number	Philips 12NC
LED Modules	2700 K	523-000072-04	910503704258
	3000 K	523-000072-05	910503704259
	3500 K	523-000072-06	910503704260
	4000 K	523-000072-07	910503704261

Item	Beam Angle	Item Number	Philips 12NC
Spread Lenses	30° x 30°	120-000161-01	910503704213
	30° x 60°	120-000161-02	910503704214
	35° x 105°	120-000161-03	910503704215
	40° x 80°	120-000161-04	910503704216
	65° x 65°	120-000161-06	910503704218
	70° x 95°	120-000161-07	910503704219
	90° x 90°	120-000161-08	910503704220

Item		Length	Item Number	Philips 12NC
Leader Cable and Accessories	Leader Cable	3 m	108-000072-13	910503705047
	Jumper Cable	0.9 m	108-000072-15	910503705049
		1.4 m	108-000072-16	910503705050
		1.7 m	108-000072-17	910503705051
	Louver		120-000161-00	910503704249

Use Item Number when ordering in North America.



Philips Color Kinetics
 3 Burlington Woods Drive
 Burlington, Massachusetts 01803 USA
 Tel 888.385.5472
 Tel 617.423.9999
 Fax 617.423.9998
www.philipscolorkinetics.com

Copyright © 2013–2015 Philips Solid-State Lighting Solutions, Inc. All rights reserved. Chromacore, Chromasic, CK, the CK logo, Color Kinetics, the Color Kinetics logo, ColorBlast, ColorBlaze, ColorBurst, eW Fuse, ColorGraze, ColorPlay, ColorReach, iW Reach, eW Reach, DIMand, EssentialWhite, eW, iColor; iColor Cove, IntelliWhite, iW, iPlayer, Optibin, and Powercore are either registered trademarks or trademarks of Philips Solid-State Lighting Solutions, Inc. in the United States and / or other countries. All other brand or product names are trademarks or registered trademarks of their respective owners. Due to continuous improvements and innovations, specifications may change without notice.

DAS-000122-05 R03 04-15