

Date: _____ Type: _____

Firm Name: _____

Project: _____

SkyRibbon

Essential White Wall Grazing Powercore, 4000 K, 10° × 10° native (no spread lens)

Recessed linear interior LED wall grazing fixture with solid white light

SkyRibbon Essential White Wall Grazing Powercore is a recessed linear interior LED wall grazing fixture offering high-quality, dimmable solid white light in four color temperatures, ranging from warm 2700 K to cool 4000 K. Brilliant light output and industry-leading color consistency make fixtures ideal for a variety of interior wall-grazing applications. Multiple housing options accommodate a number of installation methods.

- Four color temperatures — Solid white light LED modules available in 2700 K, 3000 K, 3500 K, and 4000 K color temperatures, supporting a broad selection of design objectives.
- High-quality illumination in a variety of beam angles — Native 10° × 10° beam angle. Holographic diffusion lenses offer additional 10° × 60°, 10° × 90°, 30° × 30°, and 30° × 60° beam angle options for design flexibility.
- Multiple housing options for installation and mounting flexibility — T-Bar, Slotted-T, Flanged, and Flangeless housings support numerous installation methods and appearances.
- Flexible configuration — Available in 300 mm (1 ft) and 1200 mm (4 ft) fixture lengths with multiple jumper cables, corners, terminals, and connector options to accommodate nearly any layout.
- Integrates patented Powercore technology — Powercore rapidly, efficiently, and accurately controls power output to fixtures directly from line voltage, eliminating the need for an external power supply.
- Dimming capability — Patented DIMand technology offers smooth dimming capability with selected commercially available reverse-phase ELV-type dimmers.
- Optibin advanced binning algorithm — Exceeds the recognized standards for color quality to guarantee uniformity and color consistency across LED sources, fixtures, and manufacturing runs.
- Three voltage options — Available 120 VAC, 220 – 240 VAC, and 277 VAC fixtures ensure consistent operation worldwide.

For detailed product information, please refer to SkyRibbon Essential White Wall Grazing Powercore Product Guide at www.philipscolorkinetics.com/ls/ew/skyribbon-wall-grazing/

PHILIPS

CE Dimensional Diagrams

SkyRibbon Wall Grazing Powercore Flanged Housing, 220 – 240 VAC

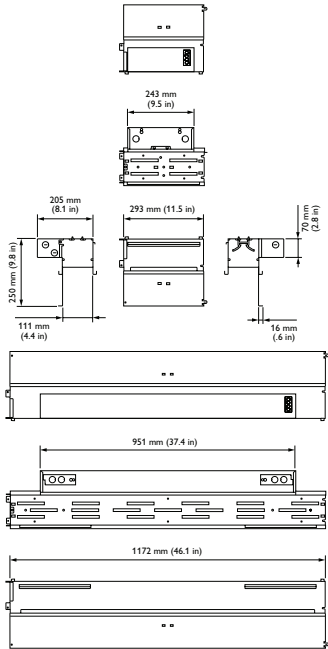

SkyRibbon Wall Grazing Powercore Flangeless Housing, 220 – 240 VAC

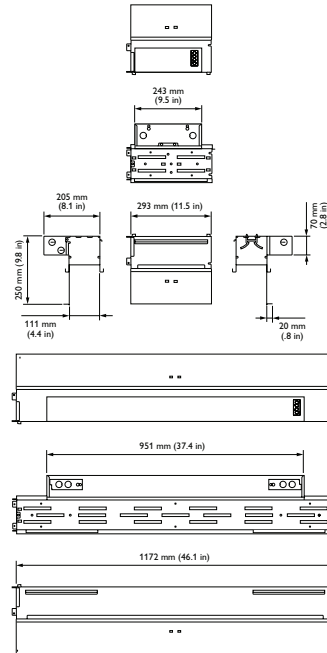

SkyRibbon Wall Grazing Powercore T-Bar / Slotted-T Housing, 220 – 240 VAC

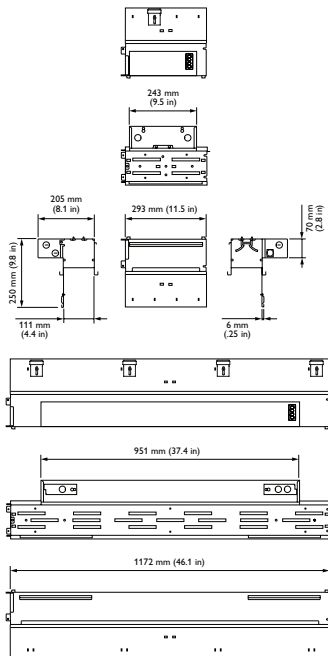

UL Dimensional Diagrams

SkyRibbon Wall Grazing Powercore Flanged Housing, 120 / 277 VAC

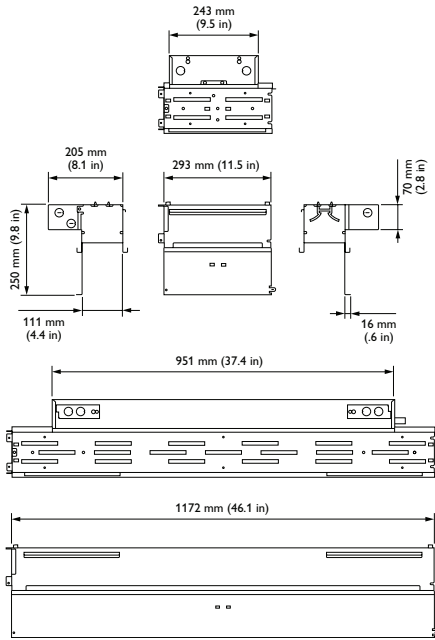

SkyRibbon Wall Grazing Powercore Flangeless Housing, 120 / 277 VAC

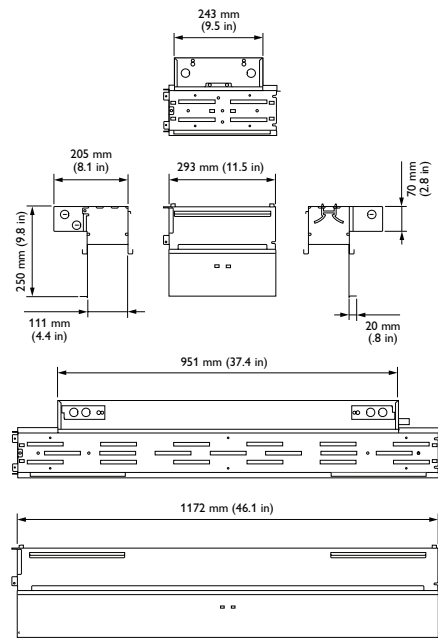

SkyRibbon Wall Grazing Powercore T-Bar / Slotted-T Housing, 120 / 277 VAC

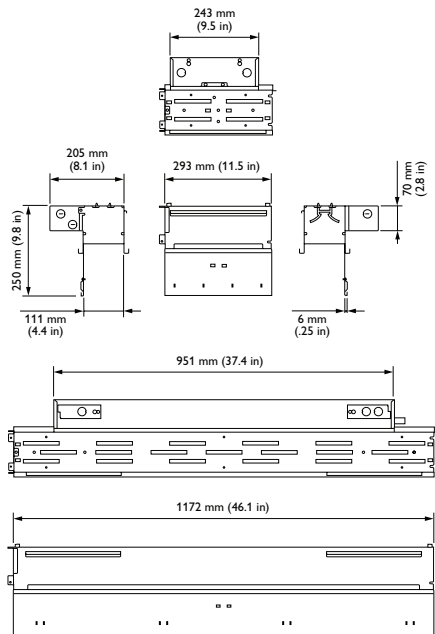

Photometrics / SkyRibbon Essential White Wall Grazing Powercore, 4000 K, 10° x 10° native (no spread lens), .3 m (1 ft)

Photometric data is based on test results from an independent NIST traceable testing lab. IES data is available at www.philipscolorkinetics.com/support/ies.

Lumens	Efficacy
1033	64.9 lm / W

Polar Candela Distribution

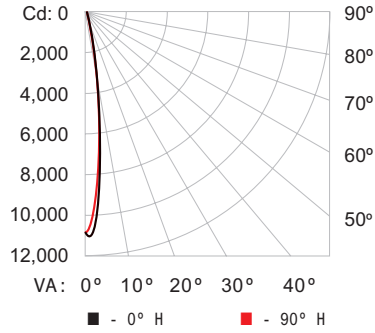

	0	25	45	70	90
0	10915	10915	10915	10915	10915
5	8636	8384	8388	8165	7756
15	508	536	602	677	635
25	148	147	145	133	130
35	149	148	151	139	129
45	111	112	110	105	90
55	80	78	75	69	58
65	58	57	54	46	35
75	30	32	33	27	16
85	22	21	18	11	3
90	21	20	16	9	1

Illuminance at Distance

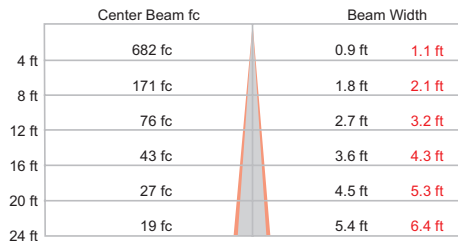

104.7 ft (31.9 m) Vert. Spread: 12.9°
 1 fc maximum distance Horiz. Spread: 15.2°

Coefficients Of Utilization - Zonal Cavity Method

Effective Floor Cavity Reflectance: 20%

RCC %:	80	70	50	30	10	0													
RW %:	70	50	30	0	70	50	30	0	50	30	20	50	30	20	0				
RCR:	0	119	119	119	119	116	116	116	99	110	110	110	105	105	105	101	101	101	99
	1	114	111	109	107	111	109	107	93	104	103	101	100	99	98	97	96	95	93
	2	109	105	101	98	107	103	100	89	99	97	94	96	94	92	93	92	90	88
	3	105	99	95	92	103	98	94	86	95	92	89	93	90	88	90	88	86	85
	4	101	95	91	87	100	94	90	83	92	88	85	90	87	84	88	85	83	82
	5	98	92	87	83	97	91	86	80	89	85	82	87	84	81	85	83	81	79
	6	95	88	84	81	94	88	83	78	86	82	80	85	81	79	83	81	78	77
	7	93	86	81	78	92	85	81	76	84	80	77	83	79	77	82	79	76	75
	8	91	84	79	76	89	83	79	75	82	78	76	81	78	75	80	77	75	74
	9	89	82	77	74	88	81	77	73	80	77	74	79	76	74	79	76	73	72
	10	87	80	76	73	86	79	76	72	79	75	73	78	75	72	77	74	72	71

Zonal Lumen

Zone	Lumens	% Fixture
0 - 60	958.9	92.8 %
60 - 90	59.0	5.7 %
0 - 90	1018.0	98.5 %
90 - 180	15.4	1.5 %
0 - 180	1033.4	100 %

For lux multiply fc by 10.7

Specifications / SkyRibbon Essential White Wall Grazing Powercore, 4000 K, 10° x 10° native (no spread lens), .3 m (1 ft)

Due to continuous improvements and innovations, specifications may change without notice

Item	Specification	Details
Output	Lumens*	1033
	Efficacy (lm / W)	64.9
	CRI	86
	Power Factor	.99 @ 120 VAC
	Color Temperature†	4000 K
	Lumen Maintenance‡	76,000 hours L70 @ 25° C 50,000 hours L70 @ 40° C 100,000 hours L50 @ 25° C 80,000 hours L50 @ 40° C
Electrical	Input Voltage	120 VAC, 220 – 240 VAC, 277 VAC, 50 / 60 Hz
	Power Consumption	16 W (0.3 m / 1ft 120 VAC) 60 W (1.2 m / 4ft 120 VAC) 17 W (0.3 m / 1ft 220 – 240 / 277 VAC) 60 W (1.2 m / 4ft 220 – 240 / 277 VAC)
Control	Dimming	Compatible with selected commercially available reverse-phase ELV-type dimmers§
Physical	Housing Material	Steel, white powder-coated finish
	Lens	Polycarbonate
	Fixture Connections	178 mm (7 in) flying leads, integral male / female connectors (120 / 277 VAC) Wieland integral male / female connectors (220 – 240 VAC)
	Temperature Ranges	-20° – 40° C (-4° – 104° F) Operating -20° – 40° C (-4° – 104° F) Startup -40° – 80° C (-40° – 176° F) Storage
	Fixture Run Lengths	To calculate fixture run lengths and total power consumption for your specific installation, download the Configuration Calculator from www.philipscolorkinetics.com/support/install_tool/
	Humidity	0 – 95%, non-condensing
Certification and Safety	Certification	UL / cUL, FCC Class A, CE
	Environment	Dry / Damp Location, IP20

* Lumen measurement complies with IES LM-79-08 testing procedures.

† Color temperatures conform to nominal CCTs as defined in ANSI Chromaticity Standard C78.377A.

‡ L70 = 70% lumen maintenance (when light output drops below 70% of initial output).

L50 = 50% lumen maintenance (when light output drops below 50% of initial output). Ambient luminaire temperatures specified. Lumen maintenance calculations are based on lifetime prediction graphs supplied by LED source manufacturers. Calculations for white-light LED fixtures are based on measurements that comply with IES LM-80-08 testing procedures. Refer to www.philipscolorkinetics.com/support/appnotes/lm-80-08.pdf for more information.

§ Refer to www.philipscolorkinetics.com/support/appnotes/ for specific details.





Dimensions and Weight

Fixture	Physical Characteristics	T-Bar / Slotted-T	Flanged	Flangeless
.3 m (1 ft)	Housing Dimensions <i>Height x Width x Depth</i>	251 x 293 x 205 mm (9.9 x 11.5 x 8.1 in)	251 x 293 x 205 mm (9.9 x 11.5 x 8.1 in)	251 x 293 x 205 mm (9.9 x 11.5 x 8.1 in)
	Assembled Weight†	3.3 kg (7.3 lbs)	3.3 kg (7.3 lbs)	3.3 kg (7.3 lbs)
1.2 m (4 ft)	Housing Dimensions <i>Height x Width x Depth</i>	251 x 1172 x 205 mm (9.9 x 46.1 x 8.1 in)	251 x 1172 x 205 mm (9.9 x 46.1 x 8.1 in)	251 x 1172 x 205 mm (9.9 x 46.1 x 8.1 in)
	Assembled Weight†	10.5 kg (23.1 lb)	10.5 kg (23.1 lb)	10.5 kg (23.1 lb)

† Assembled weight includes fixture housing and LED module.

Product Selection

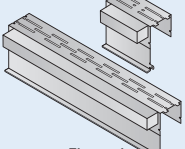
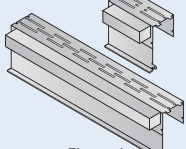
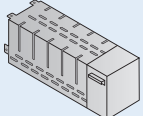
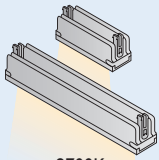
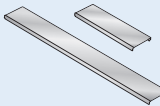
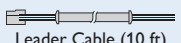
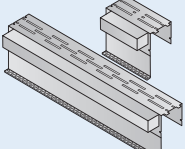
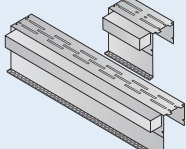
To order a complete SkyRibbon Essential White Wall Grazing Powercore fixture, choose a housing (voltage, length, and type), an LED module, a spread lens, a Leader Cable, and optional Jumper Cables and louvers.

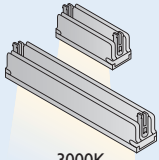
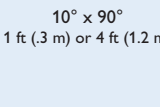
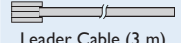
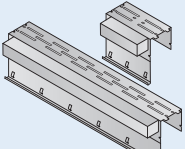
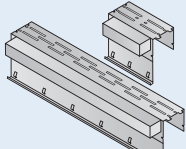
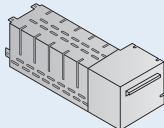
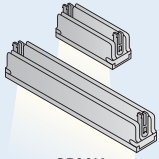
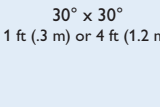
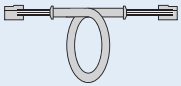
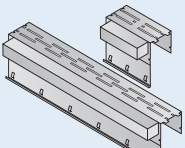
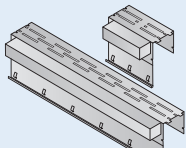
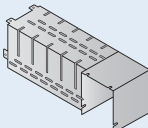
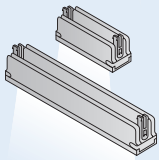
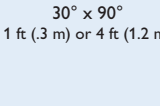
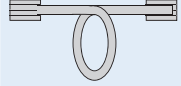
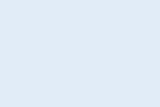
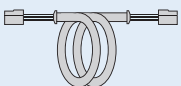
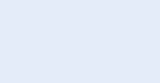
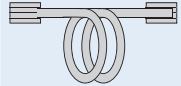
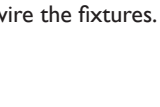
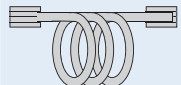
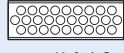
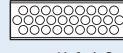
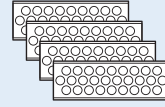
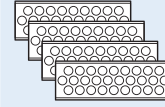
1 Choose housing type		2 Choose terminal housing and optional corners		3 Choose LED Module		4 Choose optional spread lens		5 Choose optional accessories			
120 VAC or 277 VAC		220 – 240 VAC		Terminal		2700K 1 ft (.3 m) or 4 ft (1.2 m)		120 VAC / 277 VAC			
 Flanged 1 ft (.3 m) or 4 ft (1.2 m)		 Flanged 1 ft (.3 m) or 4 ft (1.2 m)		 Terminal		 2700K 1 ft (.3 m) or 4 ft (1.2 m)		 10° x 60° 1 ft (.3 m) or 4 ft (1.2 m)		220 – 240 VAC  Leader Cable (10 ft)	
 Flangeless 1 ft (.3 m) or 4 ft (1.2 m)		 Flangeless 1 ft (.3 m) or 4 ft (1.2 m)		 Joiner Plate (to terminate run)		 3000K 1 ft (.3 m) or 4 ft (1.2 m)		 30° x 90° 1 ft (.3 m) or 4 ft (1.2 m)		 Leader Cable (3 m)	
 T-Bar 1 ft (.3 m) or 4 ft (1.2 m)		 T-Bar 1 ft (.3 m) or 4 ft (1.2 m)		 Inside Corner		 3500K 1 ft (.3 m) or 4 ft (1.2 m)		 30° x 30° 1 ft (.3 m) or 4 ft (1.2 m)		 Jumper Cable (1 ft)	
 Slotted-T 1 ft (.3 m) or 4 ft (1.2 m)		 Slotted-T 1 ft (.3 m) or 4 ft (1.2 m)		 Outside Corner		 4000K 1 ft (.3 m) or 4 ft (1.2 m)		 30° x 90° 1 ft (.3 m) or 4 ft (1.2 m)		 Jumper Cable (0.9 m)	
								 10° x 90° 1 ft (.3 m) or 4 ft (1.2 m)		 Jumper Cable (4 ft)	
								 30° x 30° 1 ft (.3 m) or 4 ft (1.2 m)		 Jumper Cable (1.4 m)	
								 30° x 90° 1 ft (.3 m) or 4 ft (1.2 m)		 Jumper Cable (1.7 m)	
								 Louver (1 ft / .3 m)		 Louver (1 ft / .3 m)	
								 Louver Kit (4 ft / 1.2 m)		 Louver Kit (4 ft / 1.2 m)	

For 220—240 VAC installations, you must use leader and jumper cables.

For 120 / 277 VAC installations, you can either use leader and jumper cables or hardwire the fixtures. When hardwiring, the fixture acts as a junction box.

Housing and Terminal Options

Item	Style	Length	Voltage	Item Number	Philips 12NC
Housing	Flanged	300 mm	220–240 VAC	172-000073-27	910503704343
		1200 mm	220–240 VAC	172-000073-25	910503704341
		1 ft	120 / 277 VAC	172-000073-04	910503704174
		4 ft	120 VAC	172-000073-01	910503704171
	277 VAC		172-000073-13	910503704329	
	Flangeless	300 mm	220–240 VAC	172-000073-41	910503705012
		1200 mm	220–240 VAC	172-000073-43	910503705014
		1 ft	120 / 277 VAC	172-000073-05	910503704321
		4 ft	120 VAC	172-000073-02	910503704172
	277 VAC		172-000073-14	910503704330	
	T-Bar / Slotted-T	300 mm	220–240 VAC	172-000073-26	910503704342
		1200 mm	220–240 VAC	172-000073-24	910503704340
		1 ft	120 / 277 VAC	172-000073-03	910503704173
		4 ft	120 VAC	172-000073-00	910503704170
	277 VAC		172-000073-12	910503704328	
	Inside 90° Corner	Flanged		172-000073-33	910503704357
Flangeless			172-000073-34	910503704358	
T-Bar / Slotted-T			172-000073-32	910503704356	
Outside 90° Corner	Flanged		172-000073-36	910503704360	
	Flangeless		172-000073-37	910503704361	
	T-Bar / Slotted-T		172-000073-35	910503704359	
Terminal Housing	Flanged		172-000073-39	910503704989	
	Flangeless		172-000073-40	910503704990	
	T-Bar / Slotted-T		172-000073-38	910503704988	
Joiner Plate	Compatible with All Housing Versions			172-000073-63	912400133612

Use Item Number when ordering in North America.

LED Modules, Spread Lenses, and Louvers

Item	Length	Details	Item Number	Philips 12NC
LED Modules	.3 m / 1 ft	2700 K	523-000073-00	910503702652
	.3 m / 1 ft	3000 K	523-000073-02	910503702654
	.3 m / 1 ft	3500 K	523-000073-04	910503702656
	.3 m / 1 ft	4000 K	523-000073-06	910503702658
	1.2 m / 4 ft	2700 K	523-000073-01	910503702653
	1.2 m / 4 ft	3000 K	523-000073-03	910503702655
	1.2 m / 4 ft	3500 K	523-000073-05	910503702657
	1.2 m / 4 ft	4000 K	523-000073-07	910503702659
Spread Lens	.3 m / 1 ft	10° x 60°	120-000173-02	910503704574
	.3 m / 1 ft	10° x 90°	120-000173-01	910503704573
	.3 m / 1 ft	30° x 30°	120-000173-03	910503704575
	.3 m / 1 ft	30° x 60°	120-000173-04	910503704576
	1.2 m / 4 ft	10° x 60°	120-000173-07	910503704579
	1.2 m / 4 ft	10° x 90°	120-000173-14	912400130391
	1.2 m / 4 ft	30° x 30°	120-000173-08	910503704580
	1.2 m / 4 ft	30° x 60°	120-000173-09	910503704581
Louver	.3 m / 1 ft		120-000173-05	910503704577
	1.2 m / 4 ft		120-000173-13	910503705054

Use Item Number when ordering in North America.

Leader and Jumper Cables

Item	Length	Voltage	Item Number	Philips 12NC
Leader Cable	10 ft	120 / 277 VAC	108-000072-03	910503703135
	3 m	220–240 VAC	108-000072-13	910503705047
Jumper Cable	1 ft	120 / 277 VAC	108-000072-00	910503702835
	4 ft	120 / 277 VAC	108-000072-01	910503702836
	8 ft	120 / 277 VAC	108-000072-02	910503702837
	0.9 m	220–240 VAC	108-000072-15	910503705049
	1.4 m	220–240 VAC	108-000072-16	910503705050
	1.7 m	220–240 VAC	108-000072-17	910503705051

Use Item Number when ordering in North America.



Philips Color Kinetics
3 Burlington Woods Drive
Burlington, Massachusetts 01803 USA
Tel 888.385.5742
Tel 617.423.9999
Fax 617.423.9998
www.philipscolorkinetics.com

Copyright © 2014–2015 Philips Solid-State Lighting Solutions, Inc. All rights reserved. Chromacore, Chromasic, CK, the CK logo, Color Kinetics, the Color Kinetics logo, ColorBlast, ColorBlaze, ColorBurst, eW Fuse, ColorGraze, ColorPlay, ColorReach, iW Reach, eW Reach, DIMand, EssentialWhite, eW, iColor; iColor Cove, IntelliWhite, iW, iPlayer, Optibin, and Powercore are either registered trademarks or trademarks of Philips Solid-State Lighting Solutions, Inc. in the United States and / or other countries. All other brand or product names are trademarks or registered trademarks of their respective owners. Due to continuous improvements and innovations, specifications may change without notice. DAS-000125-16 R05 3-15