

## Vaya Linear LP, White & Mono

Vaya Linear LP White & Mono is a reliable and cost effective LED lighting fixture designed for static white or mono colored lighting effects. Vaya Linear LP is ideal for exterior cove lighting and low level grazing applications with a wide 120° beam or elliptical 28°x84° optics. Two lengths and a wide range of available color temperatures make this product versatile and easy to use. Input & Output connectors make installations fast, easy and reliable.



### Key Features

- Reliable, cost effective LED lighting fixture
- Slim outdoor rated housing
- Input & Output connectors
- Available with 28° x 84° or 120° Beams
- Auto-ranging 100V – 240V, 50 / 60Hz input
- Available in 4 CCTs and 4 Mono Colors
- Interior / Exterior - IP66
- 3 Years Warranty

### Product Data

Width	34.8mm (1.4in)	
Height	56.6 mm (2.0in) including mounting hinge	
Length	610 mm (2 ft)	1200 mm (4 ft)
Mounting	Location adjustable and tilting surface-mount bracket	
Source	High-brightness White, Red, Green, Blue or Amber LEDs	
Beam Angle	Elliptical (28° x 84°) or Wide (120°)	
Luminous Flux (4000K)	600 lumens	1,200 lumens
CRI (4000K)	80 Ra	
Efficacy (4000K)	62 Lumens / Watt	
Lumen Maintenance	White: 50,000 hrs L <sub>70</sub> at 25°C, Mono: 50,000 hrs L <sub>50</sub> at 25°C	
Housing	Extruded aluminum, anodized finish RAL7043	
Weight	1.0 kg (2.2 lbs)	2.0kg (4.4 lbs)
Connection	Power input and output connectors	
Lens	Tempered Glass	
Control	On/Off, Not dimmable	
Input Voltage	100V – 240 VAC, 50 / 60Hz	
Power Consumption	10 W (White), 14 W (Mono)	20 W (White), 28 W (Mono)
Temperature Range	-20°C to 40°C (-4°F ~104°F) start-up temperature -40°C to 40°C (-40°F ~104°F) operating temperature	
Protection Rating	IP66, Wet location listed, IK07	
Certifications	CE, CB	
Warranty	3 Years	

**Photometrics (Per IESNA LM-79):**

**Vaya Linear LP 3000K, 120deg, 0.6m (2ft)**

**Polar Candela Distribution**

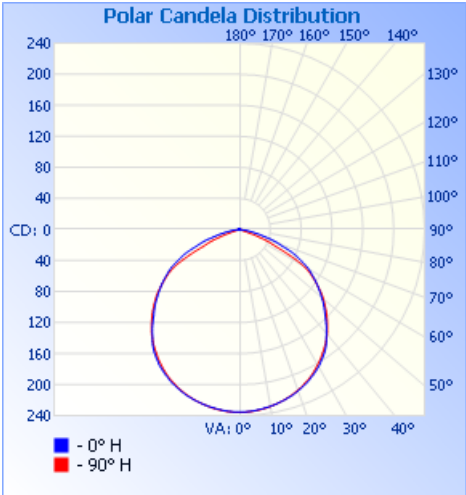

**Illuminance at a Distance**

	Center Beam LUX		Beam Width	
1.3M	132.33 LUX	4.0M	4.0M	
2.7M	33.08 LUX	8.0M	7.9M	
4.0M	14.70 LUX	12.0M	11.9M	
5.3M	8.27 LUX	16.0M	15.9M	
6.7M	5.29 LUX	20.0M	19.9M	
8.0M	3.68 LUX	24.0M	23.8M	

■ Vert. Spread: 112.7°   ■ Horiz. Spread: 112.2°

Im = 3.28ft

**Vaya Linear LP 3000K, 28x84deg, 0.6m (2ft)**

**Polar Candela Distribution**

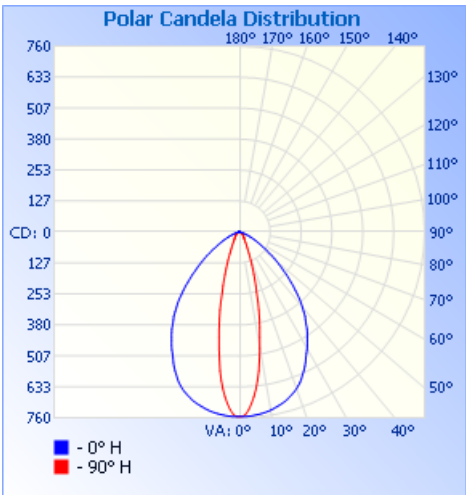

**Illuminance at a Distance**

	Center Beam LUX		Beam Width	
1.3M	424.38 LUX	2.4M	0.6M	
2.7M	106.09 LUX	4.7M	1.2M	
4.0M	47.15 LUX	7.1M	1.8M	
5.3M	26.52 LUX	9.4M	2.4M	
6.7M	16.98 LUX	11.8M	3.0M	
8.0M	11.79 LUX	14.1M	3.6M	

■ Vert. Spread: 82.9°   ■ Horiz. Spread: 25.3°

Im = 3.28ft

**Photometrics (Per IESNA LM-79):**

**Vaya Linear LP 4000K, 120deg, 0.6m (2ft)**

**Polar Candela Distribution**

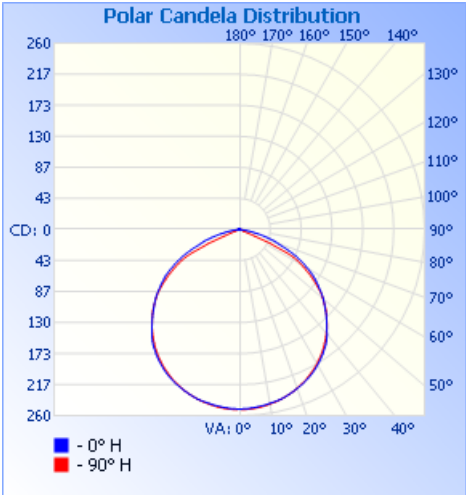

**Illuminance at a Distance**

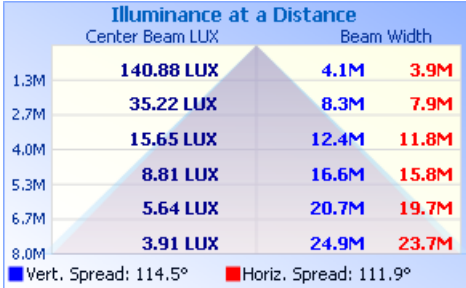

Im = 3.28ft

**Vaya Linear LP 4000K, 28x84deg, 0.6m (2ft)**

**Polar Candela Distribution**

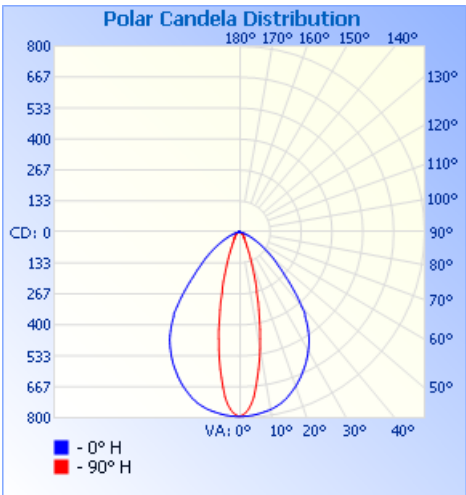

**Illuminance at a Distance**

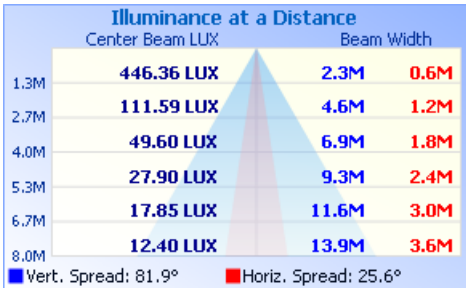

Im = 3.28ft

### Dimensions:

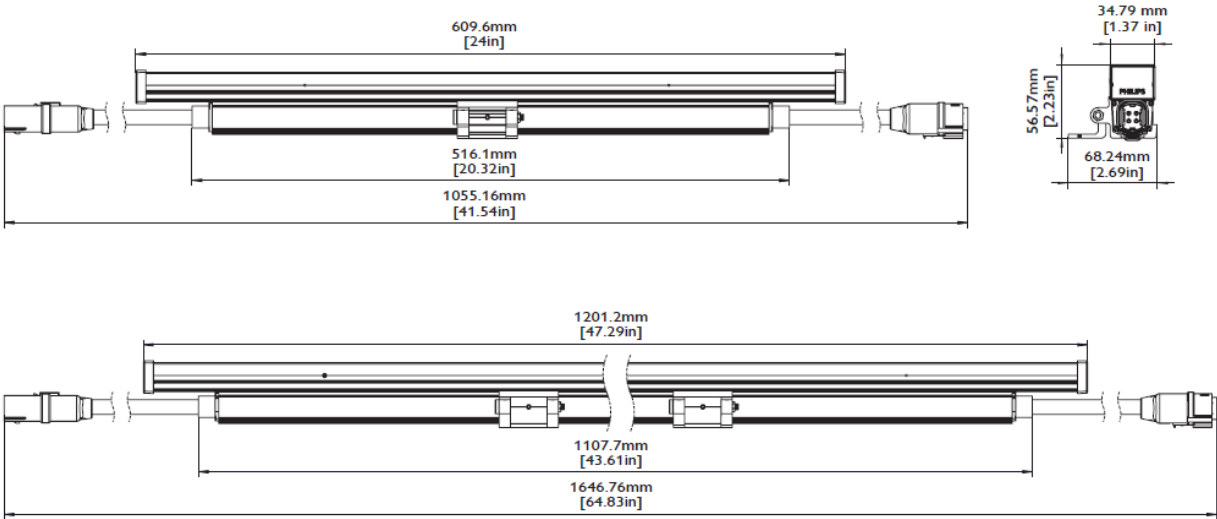

### Leader Cable Dimensions:

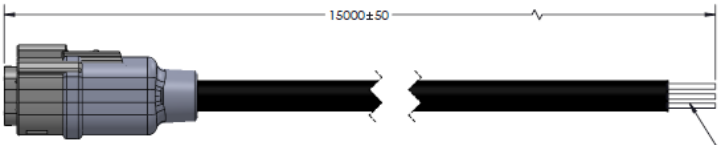

### Jumper Cable Dimensions:

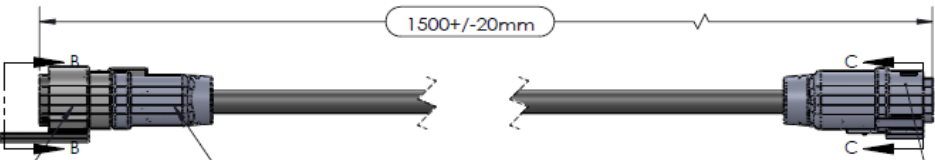

## Vaya Linear LP White Ordering Codes:

CCT	Length	Beam Angle	Philips I2NC	Item Number	Certification
3000K	0.6m	120°	910503704433	350-000010-00	CE
3000K	0.6m	28° X 84°	910503704434	350-000010-01	CE
3000K	1.2m	120°	910503704435	350-000010-02	CE
3000K	1.2m	28° X 84°	910503704436	350-000010-03	CE
4000K	0.6m	120°	910503704437	350-000010-04	CE
4000K	0.6m	28° X 84°	910503704438	350-000010-05	CE
4000K	1.2m	120°	910503704439	350-000010-06	CE
4000K	1.2m	28° X 84°	910503704440	350-000010-07	CE

<sup>1</sup>Custom options include 2700K, 5000K, Red, Green, Blue, Amber version in either lengths or beam angles.

## Vaya Linear LP-MP White & Mono Cables:

Product	Length	Philips I2NC	Item Number	Certification
Leader Cable	15m (50ft)	912400130044	308-000003-00	CE
Jumper Cable	1.5m (5ft)	912400130046	308-000003-02	CE

## Vaya Linear LP Accessories:

Product	Length	Philips I2NC	Item Number	Certification
Glare Shield	0.6m (2ft)	912400130180	320-000010-00	
Glare Shield	1.2m (4ft)	912400130181	320-000010-01	



**Vaya Linear LP Spare Parts:**

Product	Length	Philips I2NC	Item Number	Certification
Mounting Hinge	1 piece	912400133634	320-000010-02	

**Custom Options:**

CCT	Length	Beam Angle	Philips I2NC	Item Number	Certification
2700K	0.6m	120°	910503704457	350-000010-24	CE
2700K	0.6m	28° X 84°	910503704458	350-000010-25	CE
2700K	1.2m	120°	910503704459	350-000010-26	CE
2700K	1.2m	28° X 84°	910503704460	350-000010-27	CE
5000K	0.6m	120°	910503704518	350-000010-36	CE
5000K	0.6m	28° X 84°	910503704519	350-000010-37	CE
5000K	1.2m	120°	910503704520	350-000010-38	CE
5000K	1.2m	28° X 84°	910503704521	350-000010-39	CE
Red	0.6m	120°	910503704481	325-000010-00	CE
Red	0.6m	28° X 84°	910503704482	325-000010-01	CE
Red	1.2m	120°	910503704483	325-000010-02	CE
Red	1.2m	28° X 84°	910503704484	325-000010-03	CE
Green	0.6m	120°	910503704485	325-000010-04	CE
Green	0.6m	28° X 84°	910503704486	325-000010-05	CE
Green	1.2m	120°	910503704487	325-000010-06	CE
Green	1.2m	28° X 84°	910503704488	325-000010-07	CE
Blue	0.6m	120°	910503704489	325-000010-08	CE
Blue	0.6m	28° X 84°	910503704490	325-000010-09	CE
Blue	1.2m	120°	910503704491	325-000010-10	CE
Blue	1.2m	28° X 84°	910503704492	325-000010-11	CE
Amber	0.6m	120°	910503704493	325-000010-12	CE
Amber	0.6m	28° X 84°	910503704494	325-000010-13	CE
Amber	1.2m	120°	910503704495	325-000010-14	CE
Amber	1.2m	28° X 84°	910503704496	325-000010-15	CE