

Vaya Flood LP G2, White & Mono

Vaya Flood LP (gen2) is a reliable and cost effective white light fixture for both interior and exterior use. Vaya Flood LP White & Mono is designed for general purpose flood, wash and accent lighting applications. Integrated power and adjustable tilt angle make this product versatile and easy to use.



Key Features

- Up to 10lx at 60m / 1fc at 196ft
- Compact die-cast aluminium housing
- Robust design & IP66 rating for outdoor use
- Available in standard 3000K & 4000K
- Available with standard 20° or 40° beams
- Auto-ranging 100V-240V AC, 50 / 60Hz input
- DLC-listed with 5 years limited warranty

Product Data

Height	223 mm (8.78in), including surface mount base	
Width	236 mm (9.31in)	
Depth	77.4 mm (3.05in), excluding mounting base	
Mounting	Integrated tilting surface-mount base	
Source	High-brightness White or Mono LEDs	
Standard Beam Angles	20° or 40°	
Luminous Flux	3,380 lumens	
Efficacy	79lm/W	
CRI	80 Ra	
Lumen Maintenance	50,000 hrs L ₇₀ at 25°C	
Housing	Die Cast Aluminum, powder-coated finish RAL7043	
Weight	3.0 kg (6.6 lbs)	
Connector	3-conductor whip for power, 1.5m (5ft) long	
Lens	Tempered glass	
Control	On / Off (standard) or DMX-dimmable (custom option)	
Input Voltage	100V-240V AC, 50 / 60Hz	
Power Consumption	44W	47W
Temperature Range	-20°C to 40°C (-4°F ~104°F) start-up temperature -40°C to 40°C (-40°F ~104°F) operating temperature	
Protection Rating	IP66, Wet location listed, IK09	
Certifications	UL / cUL, FCC Class A	
Warranty	5 Years	

Photometrics (Per IESNA LM-79):

Vaya Flood LP G2 3000K, 20deg

Polar Candela Distribution

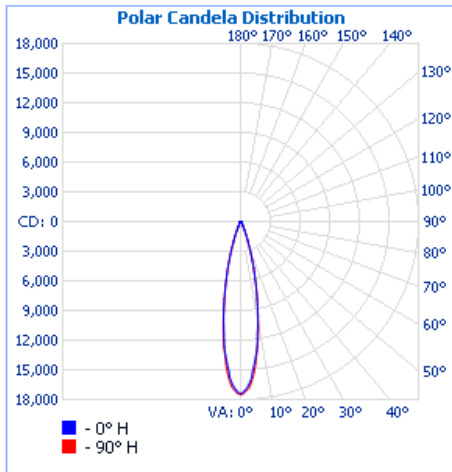

Illuminance at a Distance

	Center Beam LUX	Beam Width	
8.33M	248 LUX	3.33 M	3.38 M
16.67M	62.1 LUX	6.66 M	6.76 M
25.00M	27.6 LUX	9.99 M	10.13 M
33.33M	15.5 LUX	13.31 M	13.51 M
41.67M	9.93 LUX	16.64 M	16.89 M
50.00M	6.90 LUX	19.97 M	20.27 M

■ Vert. Spread: 22.6°
■ Horiz. Spread: 22.9°

Im = 3.28ft

Vaya Flood LP G2 3000K, 40deg

Polar Candela Distribution

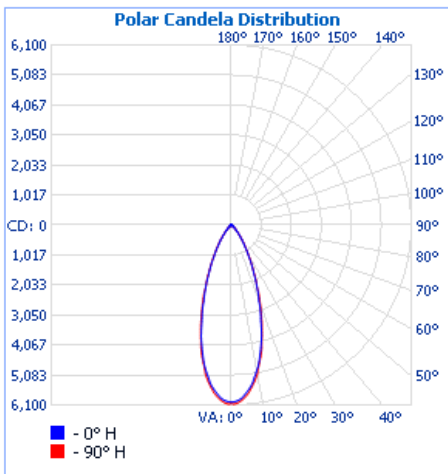

Illuminance at a Distance

	Center Beam LUX	Beam Width	
8.33M	86.4 LUX	5.67 M	5.86 M
16.67M	21.6 LUX	11.34 M	11.71 M
25.00M	9.60 LUX	17.02 M	17.57 M
33.33M	5.40 LUX	22.69 M	23.42 M
41.67M	3.46 LUX	28.36 M	29.28 M
50.00M	2.40 LUX	34.03 M	35.13 M

■ Vert. Spread: 37.6°
■ Horiz. Spread: 38.7°

Im = 3.28ft

Photometrics (Per IESNA LM-79):

Vaya Flood LP G2 4000K, 20deg

Polar Candela Distribution

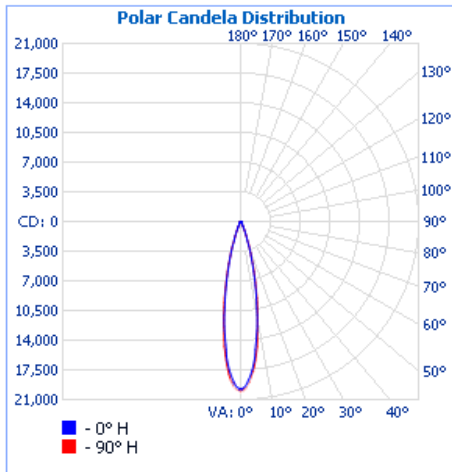

Illuminance at a Distance

	Illuminance at a Distance	
	Center Beam LUX	Beam Width
8.33M	284 LUX	3.28 M 3.36 M
16.67M	70.9 LUX	6.56 M 6.73 M
25.00M	31.5 LUX	9.85 M 10.09 M
33.33M	17.7 LUX	13.13 M 13.45 M
41.67M	11.3 LUX	16.41 M 16.82 M
50.00M	7.88 LUX	19.69 M 20.18 M

■ Vert. Spread: 22.3°
■ Horiz. Spread: 22.8°

Im = 3.28ft

Vaya Flood LP G2 4000K, 40deg

Polar Candela Distribution

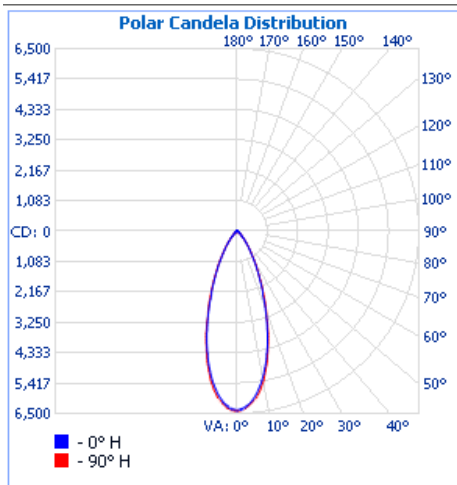

Illuminance at a Distance

	Illuminance at a Distance	
	Center Beam LUX	Beam Width
8.33M	91.4 LUX	5.68 M 5.80 M
16.67M	22.9 LUX	11.35 M 11.60 M
25.00M	10.2 LUX	17.03 M 17.40 M
33.33M	5.71 LUX	22.71 M 23.20 M
41.67M	3.66 LUX	28.38 M 29.00 M
50.00M	2.54 LUX	34.06 M 34.80 M

■ Vert. Spread: 37.6°
■ Horiz. Spread: 36.4°

Im = 3.28ft

Dimensions:

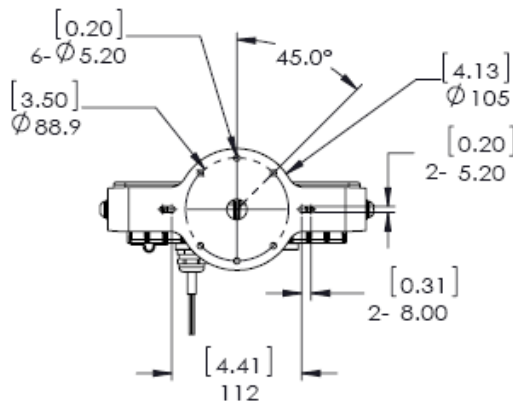
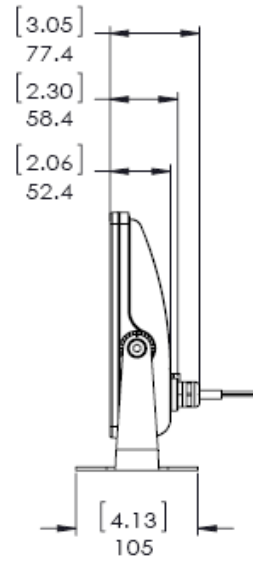
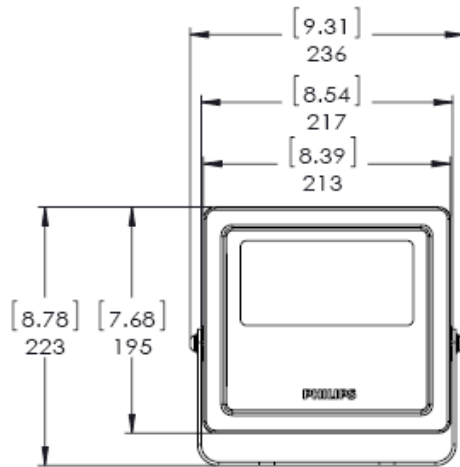

Ordering Codes:

CCT	Beam Angle	Philips I2NC	Item Number	Certification
3000K	20°	912400133929	350-000015-17	UL / cUL
3000K	40°	912400133958	350-000015-18	UL / cUL
4000K	20°	912400133935	350-000015-25	UL / cUL
4000K	40°	912400133938	350-000015-26	UL / cUL

¹ Custom options include 2700K, 5000K, Red, Green, Blue, Amber color options

² Custom options include narrow (10°) & open beam (90°) versions

Custom Options / On-Off:

CCT	Beam Angle	Philips I2NC	Item Number	Certification
3000K	10°	912400133928	350-000015-16	UL / cUL
4000K	10°	912400133932	350-000015-24	UL / cUL
2700K	10°	912400133951	350-000015-48	UL / cUL
2700K	20°	912400133949	350-000015-49	UL / cUL
2700K	40°	912400133950	350-000015-50	UL / cUL
5000K	10°	912400133946	350-000015-56	UL / cUL
5000K	20°	912400133955	350-000015-57	UL / cUL
5000K	40°	912400133968	350-000015-58	UL / cUL
3000K	Open Beam	912400133961	350-000015-65	UL / cUL
4000K	Open Beam	912400133943	350-000015-68	UL / cUL
2700K	Open Beam	912400133965	350-000015-71	UL / cUL
5000K	Open Beam	912400133971	350-000015-74	UL / cUL

Custom Options / DMX Dimmable:

CCT	Beam Angle	Philips I2NC	Item Number	Certification
3000K	10°	823500402101	399-015000-00	UL / cUL
3000K	20°	823500402102	399-015000-01	UL / cUL
3000K	40°	823500402103	399-015000-02	UL / cUL
4000K	10°	823500402104	399-015000-03	UL / cUL
4000K	20°	823500402105	399-015000-04	UL / cUL
4000K	40°	823500402106	399-015000-05	UL / cUL
2700K	10°	823500402107	399-015000-06	UL / cUL
2700K	20°	823500402108	399-015000-07	UL / cUL
2700K	40°	823500402109	399-015000-08	UL / cUL
5000K	10°	823500402110	399-015000-09	UL / cUL
5000K	20°	823500402111	399-015000-10	UL / cUL
5000K	40°	823500402112	399-015000-11	UL / cUL
3000K	Open Beam	823500402113	399-015000-12	UL / cUL
4000K	Open Beam	823500402114	399-015000-13	UL / cUL
2700K	Open Beam	823500402115	399-015000-14	UL / cUL
5000K	Open Beam	823500402116	399-015000-15	UL / cUL