



# PureGlow IntelliHue Powercore

10° x 60°, 305 mm (12 in), Narrow Beam Angle

Premium concealed interior linear LED fixture with intelligent white and color light

Innovative PureGlow Powercore luminaires bring lighting professionals high output in a compact, easily concealed luminaire. PureGlow delivers exceptionally high-quality light for a wide range of interior applications from cove to wall-washing to backlighting and beyond. Here are just some of the powerful advantages that PureGlow brings to lighting professionals and their clients.

# PureGlow IntelliHue Powercore

## Premium concealed interior linear LED fixture with intelligent white and color light

- Unbeatable Performance – Major innovations, including a unique optical cluster, enable PureGlow to deliver up to 95 CRI, lumen outputs of up to 800 lm, and color temperatures that range from 2000K to 10000K – all with superior beam quality that delivers bright, smooth light.
- Innovative Design – With its compact size and an extremely short mixing distance, PureGlow can excel in areas where traditional linear luminaires are impractical. It's available in 305 mm (1 ft) and 1219 mm (4 ft) die-cast aluminum housings, as well as a range of beam angles – including wide (100° x 100°), medium (30° x 60°), and narrow (10° x 60°). Interlocking connectors ensure end-to-end installation without visible light scalloping between fixtures – just pure, seamless light.
- Superior Color Consistency – Improves color consistency between all LED fixtures in a family with Chromasync technology. During the manufacturing process a calibrated light measurement device creates an algorithm to define a common color gamut for an entire family of LED fixtures. When Chromasync is enabled, color consistency between fixtures is achieved without having to manually adjust color points on each fixture.
- White and Color Light – PureGlow combines tunable white and dynamic color light in one innovative, high-performance luminaire that's easy to install and control.
- High R9 Values – PureGlow delivers R9 values that can reach up to 81. Saturated red light gives objects and surfaces a vibrant and rich color that is ideal for spaces where ambience is important.
- Industry-Leading Controls – PureGlow luminaires work seamlessly with the complete Philips Color Kinetics line of controllers, including iPlayer 3, Light System Manager, and ColorDial Pro – as well as third-party controllers.
- Higher Efficiency, Lower Cost – All PureGlow luminaires integrate Powercore technology, which controls power output to fixtures directly from line voltage – rapidly, efficiently, and accurately. The Philips Color Kinetics Data Enabler Pro merges line voltage with control, and delivers them to the luminaire over a single standard cable – simplifying installation dramatically and lowering total system cost.
- Easy Installation – PureGlow luminaires accept power input of 100 – 277 VAC for consistent installation anywhere in the world. Powercore allows long runs and eliminates the need for special wiring and external power supplies. For example, special connectors enable PureGlow luminaires to be connected directly (using jumper cables) with leader cables or with the terminator.

For detailed product information, please refer to the PureGlow IntelliHue Powercore Product Guide at [www.colorkinetics.com/ls/IntelliHue/Pureglow/](http://www.colorkinetics.com/ls/IntelliHue/Pureglow/)

## Dimensions

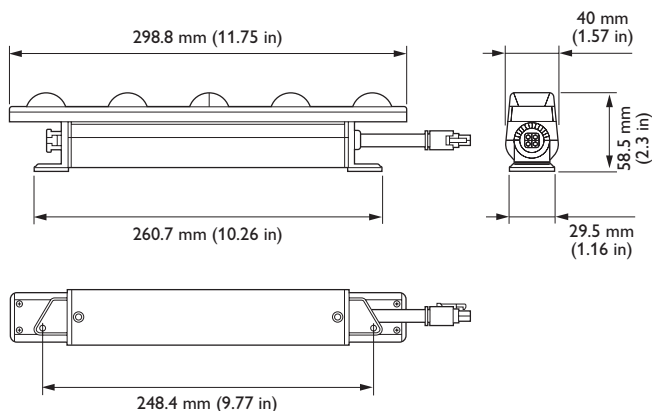

# Specifications

Due to continuous improvements and innovations, specifications may change without notice.

PureGlow IntelliHue Powercore, 10° x 60°, 305 mm (12 in), Narrow Beam Angle

## Output

Beam Angle	10° x 60°
Lumens 2700 K†	764
Lumens 4000 K	707
Efficacy (lm/W) 2700 K	60
Efficacy (lm/W) 4000 K	59
CRI 2700 K	93.3
CRI 4000 K	93.3
CRI R9 2700K	82
CRI R9 4000 K	68.2

## Electrical

Input Voltage	100 – 277 VAC, auto-ranging, 50/60 Hz
Power Consumption <i>(Maximum at full output, steady state)</i>	13 W
Power Factor	0.9 @ 100 – 240 VAC
Power Factor	0.85 @ 277 VAC

## Control

Interface	Data Enabler Pro (DMX or Ethernet)
Control System	Philips full range of controllers, including Light System Manager, ColorDial Pro, and iPlayer 3, or third-party controllers

## Lumen Maintenance

Threshold§	Ambient Temperature	Reported††	Calculated††
L <sub>50</sub>	25° C	47100	72300
	50° C	47100	72300

## Physical

Dimensions <i>(Height x Width x Depth)</i>	58.5 x 298.8 x 40 mm (2.3 x 11.75 x 1.57 in)
Weight	0.5 kg (1.1 lb)
Housing Material	Die-cast aluminium, white powder-coated finish
Lens	Polycarbonate
Fixture Connections	Integral male/female connectors
Temperature Ranges	-20° – 50° C (-4° – 122° F) Operating -20° – 50° C (-4° – 122° F) Startup -40° – 80° C (-40° – 176° F) Storage
Humidity	0 – 95%, non-condensing

Fixture Run Length  
To calculate fixture run lengths and total power consumption for your specific installation, download the Configuration Calculator from [www.philipscolorkinetics.com/support/install\\_tool/](http://www.philipscolorkinetics.com/support/install_tool/)

## Certification and Safety

Approbation	UL/cUL, CE, FCC Class B, CE, PSE, C-Tick, SAA
Environment	Dry/Damp Location, IP20



† Lumen measurement complies with IES LM-79-08 testing procedures.

§ L<sub>xx</sub> = 50% lumen maintenance (when light output drops below 50% of initial output). All values are given at B10, or the median value where 90% of the LED population is better than the reported or calculated lumen maintenance measurement.

†† Lumen maintenance figures are based on lifetime prediction graphs supplied by LED source manufacturers. Whenever possible, figures use measurements that comply with IES LM-80-08 testing procedures. In accordance with TM-21-11, Reported values represent the interpolated value based on six times the LM-80-08 total test duration (in hours). Calculated values represent time durations that exceed six times the total test duration.

# PureGlow IntelliHue Powercore Photometrics 10° x 60°, 305 mm (12 in)

Photometric data is based on test results from an independent NIST traceable testing lab. IES data is available at [www.philipscolorkinetics.com/support/ies](http://www.philipscolorkinetics.com/support/ies).

Beam Angle	10° x 60°
LED	2700 K
Lumens 2700 K	764
Efficacy (lm/W) 2700 K	60

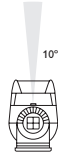

## Polar Candela Distribution

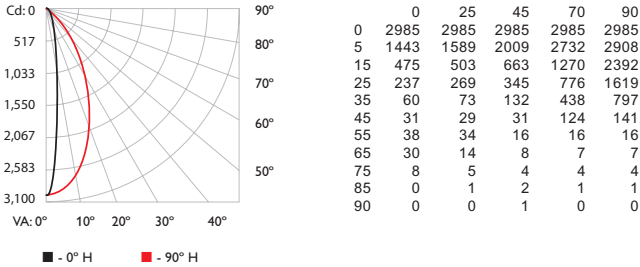

## Zonal Lumen

Zone	Lumens	% Luminaire
0-30	567.6	73.0%
0-40	689.9	88.8%
0-60	757.0	97.4%
0-90	776.9	100.0%
60-90	19.9	2.6%
70-100	7.9	1.0%
90-120	0.1	0.0%
90-180	0.1	0.0%
0-180	777.0	100.0%

## Illuminance at Distance

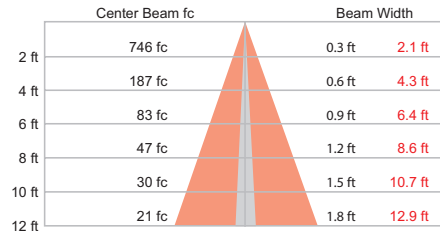

54.6 ft (16.6 m)  
1 fc maximum distance  
Vert. Spread: 8.6°  
Horiz. Spread: 56.3°

## Coefficients of Utilization - Zonal Cavity Method

RCC %:	Effective Floor Cavity Reflectance: 20%																	
	80			70			50			30			10			0		
RW %:	70	50	30	0	70	50	30	0	50	30	20	50	30	20	50	30	20	0
RCR:	0	1.19	1.19	1.19	1.16	1.16	1.16	1.00	1.11	1.11	1.11	1.06	1.06	1.06	1.02	1.02	1.02	1.00
	1	1.14	1.11	1.08	1.06	1.11	1.09	1.06	0.94	1.05	1.03	1.01	1.01	0.99	0.98	0.97	0.96	0.95
	2	1.08	1.03	0.99	0.96	1.06	1.02	0.98	0.88	0.98	0.95	0.93	0.95	0.93	0.91	0.93	0.91	0.89
	3	1.03	0.97	0.92	0.88	1.01	0.95	0.91	0.83	0.93	0.89	0.86	0.90	0.87	0.84	0.88	0.85	0.83
	4	0.98	0.91	0.85	0.81	0.96	0.90	0.85	0.78	0.88	0.83	0.80	0.86	0.82	0.79	0.84	0.81	0.78
	5	0.94	0.86	0.80	0.76	0.92	0.85	0.79	0.73	0.83	0.78	0.75	0.81	0.77	0.74	0.80	0.76	0.74
	6	0.89	0.81	0.75	0.71	0.88	0.80	0.75	0.69	0.79	0.74	0.70	0.77	0.73	0.70	0.76	0.72	0.70
	7	0.86	0.77	0.71	0.67	0.84	0.76	0.71	0.66	0.75	0.70	0.67	0.74	0.69	0.66	0.73	0.69	0.66
	8	0.82	0.73	0.67	0.64	0.81	0.72	0.67	0.62	0.71	0.67	0.63	0.70	0.66	0.63	0.69	0.66	0.63
	9	0.79	0.70	0.64	0.60	0.78	0.69	0.64	0.60	0.68	0.63	0.60	0.67	0.63	0.60	0.67	0.63	0.60
	10	0.76	0.67	0.61	0.58	0.75	0.66	0.61	0.57	0.65	0.61	0.57	0.65	0.60	0.57	0.64	0.60	0.57

For lux multiply fc by 10.7

# PureGlow IntelliHue Powercore Photometrics 4000 K, 10° x 60°, 305 mm (12 in)

Photometric data is based on test results from an independent NIST traceable testing lab. IES data is available at [www.philipscolorkinetics.com/support/ies](http://www.philipscolorkinetics.com/support/ies).

Beam Angle	10° x 60°
LED	4000 K
Lumens 4000 K	707
Efficacy (lm/W) 4000 K	59

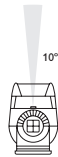

## Polar Candela Distribution

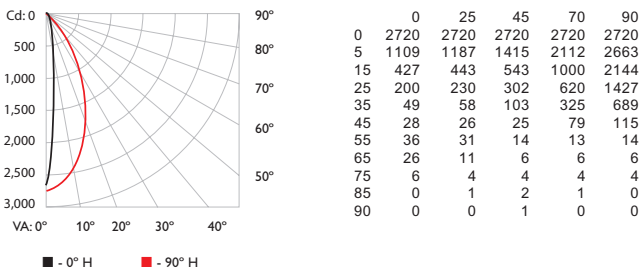

## Zonal Lumen

Zone	Lumens	% Luminaire
0-30	537.4	73.8%
0-40	648.9	89.1%
0-60	709.9	97.5%
0-90	728.0	100.0%
60-90	18.2	2.5%
70-100	7.3	1.0%
90-120	0.1	0.0%
90-180	0.1	0.0%
0-180	728.1	100.0%

## Illuminance at Distance

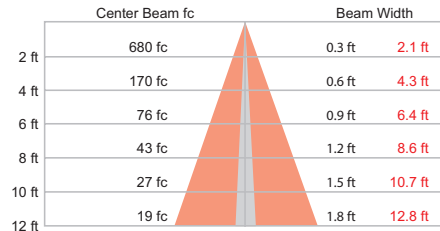

52.2 ft (15.9 m)  
1 fc maximum distance  
Vert. Spread: 8.7°  
Horiz. Spread: 56.2°

## Coefficients of Utilization - Zonal Cavity Method

RCC %:	Effective Floor Cavity Reflectance: 20%																	
	80			70			50			30			10			0		
RW %:	70	50	30	0	70	50	30	0	50	30	20	50	30	20	50	30	20	0
RCR:	0	1.19	1.19	1.19	1.16	1.16	1.16	1.00	1.11	1.11	1.11	1.06	1.06	1.06	1.02	1.02	1.02	1.00
	1	1.14	1.11	1.08	1.06	1.11	1.09	1.06	0.94	1.05	1.03	1.01	1.01	0.99	0.98	0.97	0.96	0.95
	2	1.08	1.03	0.99	0.96	1.06	1.02	0.98	0.88	0.98	0.95	0.93	0.95	0.93	0.91	0.93	0.91	0.89
	3	1.03	0.97	0.92	0.88	1.01	0.95	0.91	0.83	0.93	0.89	0.86	0.90	0.87	0.85	0.88	0.86	0.83
	4	0.98	0.91	0.85	0.82	0.96	0.90	0.85	0.78	0.88	0.84	0.80	0.86	0.82	0.79	0.84	0.81	0.78
	5	0.94	0.86	0.80	0.76	0.92	0.85	0.80	0.74	0.83	0.79	0.75	0.82	0.78	0.75	0.80	0.77	0.74
	6	0.90	0.81	0.76	0.72	0.88	0.80	0.75	0.70	0.79	0.74	0.71	0.78	0.74	0.70	0.76	0.73	0.70
	7	0.86	0.77	0.72	0.68	0.85	0.76	0.71	0.66	0.75	0.70	0.67	0.74	0.70	0.67	0.73	0.69	0.66
	8	0.82	0.73	0.68	0.64	0.81	0.73	0.68	0.63	0.72	0.67	0.64	0.71	0.66	0.63	0.70	0.66	0.63
	9	0.79	0.70	0.65	0.61	0.78	0.70	0.64	0.60	0.69	0.64	0.61	0.68	0.63	0.60	0.67	0.63	0.60
	10	0.76	0.67	0.62	0.58	0.75	0.67	0.61	0.57	0.66	0.61	0.58	0.65	0.61	0.58	0.64	0.60	0.58

For lux multiply fc by 10.7

## Fixture and Accessories

Use Item Number when ordering in North America.

<b>Fixture</b>	Item Number	Philips 12NC
PureGlow IntelliHue Powercore 10° x 60°, 305 mm (12 in), Narrow Beam Angle	123-000025-02	912400133450
<b>Accessories</b>		
Leader Cable, UL, 3 m (10 ft)	108-000065-00	912400133637
Leader Cable, CE/CCC, 3 m (10 ft)	108-000065-01	912400133638
Jumper Cable, UL, 305 mm (1 ft)	108-000066-00	912400133639
Jumper Cable, CE/CCC, 305 mm (1 ft)	108-000066-01	912400133640
Jumper Cable, UL, 1.5 m (5 ft)	108-000066-02	912400133641
Jumper Cable, CE/CCC, 1.5 m (5 ft)	108-000066-03	912400133642
Mounting Track, White	120-000194-00	912400133643
Wiring Compartment, UL	120-000191-00	912400133644
Louwer, 305 mm (1 ft)	120-000192-02	912400133647
End Of Run Diffusers, Bag of 10	120-000196-00	912400134527
<b>Power Supplies</b>		
Data Enabler Pro, 3/4 in / 1/2 in NPT (U.S. trade size conduit)	106-000004-00	910503701210
Data Enabler Pro, PG21/PG13 (metric size conduit)	106-000004-01	910503701211

Copyright © 2016 Philips Solid-State Lighting Solutions, Inc. All rights reserved. Chromacore, Chromasic, CK, the CK logo, Color Kinetics, the Color Kinetics logo, ColorBlast, ColorBlaze, ColorBurst, eW Fuse, ColorGraze, ColorPlay, ColorReach, iW Reach, EvenBalance eW Reach, DIMand, EssentialWhite, eW, iColor, iColor Cove, IntelliWhite, iW, iPlayer, Optibin, PureGlow and Powercore are either registered trademarks or trademarks of Philips Solid-State Lighting Solutions, Inc. in the United States and / or other countries. All other brand or product names are trademarks or registered trademarks of their respective owners. Due to continuous improvements and innovations, specifications may change without notice.

DAS-000147-03 ROO 04 Mar 2016



Philips Color Kinetics  
 3 Burlington Woods Drive  
 Burlington, Massachusetts 01803 USA  
 Tel 888.385.5742  
 Tel 617.423.9999  
 Fax 617.423.9998  
[www.philipscolorkinetics.com](http://www.philipscolorkinetics.com)