

Circuit Tube Data Sheet

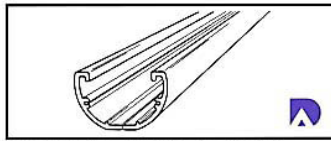

CTGB-AL6.0: Channel base T6 aluminium mill finish. 6 metre length. 3.75kg per length

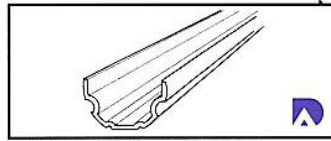

CTSJ-AL2.0: Coupler. T5 aluminium mill finish.

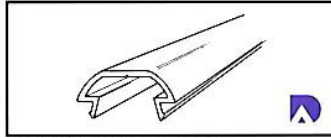

CTGCC-P: Rounded cover channel plastic.
CTGCC-AL: Rounded cover channel T5 aluminium mill finish. 3 metre length.

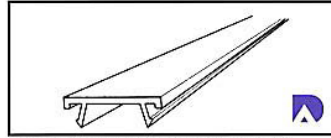

CTGCC-P: Flat cover channel plastic. 3 metre length. Self extinguishing PVC. Black, Grey, White.

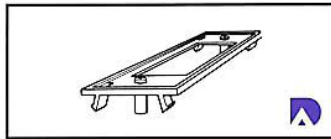

CTOMB-1: Outlet mounting base. PVC. Black, Grey, White.

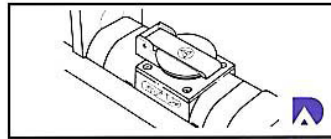

CTCP-2: Cover plate. PVC. Black, Grey, White. NB: Plug socket sold separately.

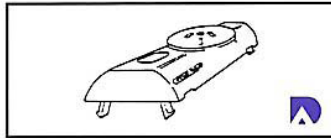

CTCP-1: Cover plate. PVC. Black, Grey, White. NB: HPM 38 series insert sold separately.

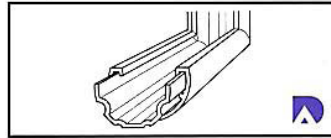

CTAV-90AL: Vertical 90 degree Two Way Angle. T6 aluminium mill finish.

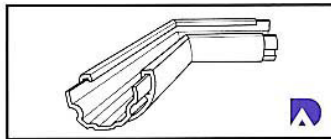

CTAF-90AL: Flat 90° Two Way Angle. T6 aluminium mill finish.

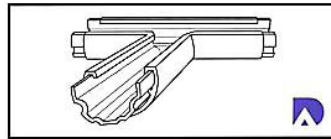

CTTF-90AL: Flat Three Way Tee. T6 aluminium mill finish.

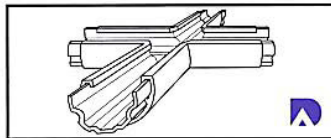

CTCF-90AL: Flat Four Way Cross. T6 aluminium mill finish.

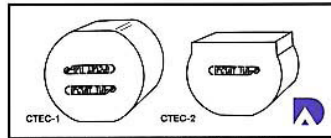

CTEC-1: Rounded end cap. PVC. Black, Grey, White.
CTEC-2: Flat end cap. PVC. Black, Grey, White.

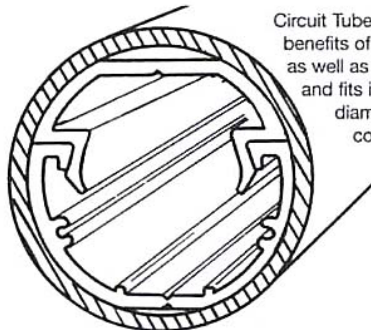

Circuit Tube provides the benefits of a square bar as well as a round tube and fits into all 50mm diameter pipes or conduit fittings.



Circuit Tube Indicative Mounting Detail

Codes shown are for Unistrut and are suggested only
Detail shows beam mounting, for slab delete F12000 bracket

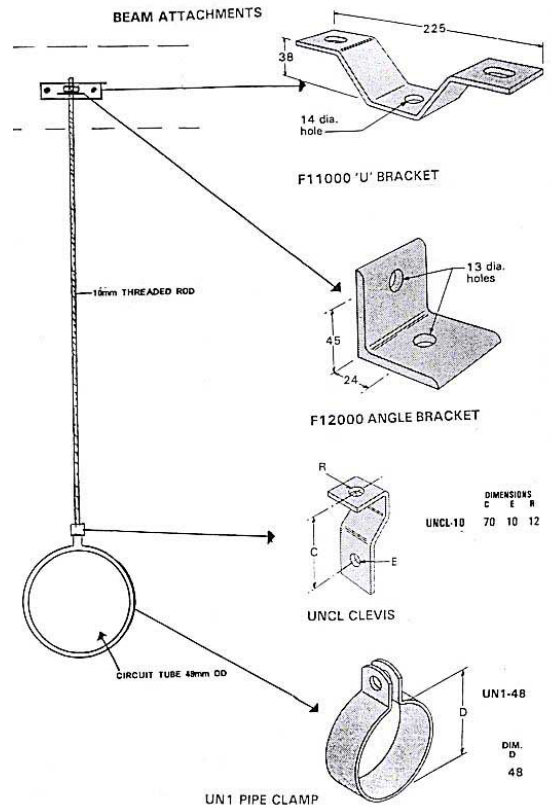

POINT LOAD TESTS

Simply supported ends with cover on top

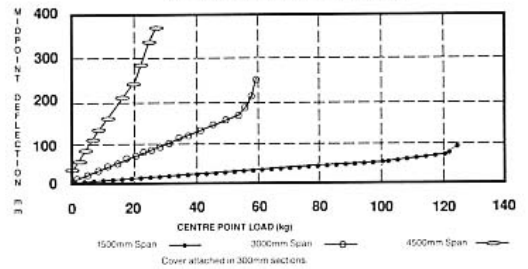

DISTRIBUTED LOAD TESTS

Simply supported ends with cover on top

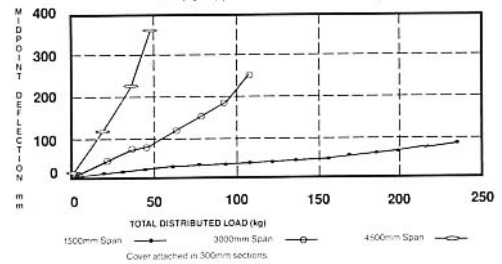

Lightmoves Pty Ltd
138-146 Browns Road
Noble Park VIC 3174
Phone: 03 9701 2500
Fax: 03 9701 2511

lightmoves
illuminating ideas
www.lightmoves.com.au