

efficiency • intelligence • easiness



## iDim Sense & Solo User Manual

## iDim Family Introduction

The iDim concept is a luminaire based lighting control solution comprising an intelligent sensor (iDim Sense 316), an interface unit (iDim Solo 403) as well as a range of ballasts (EL-iDim). Combined together they provide a unique standalone solution for intelligent single room lighting applications.

### iDim Sense - 316 (Standalone)

This luminaire based sensor provides 6 out-of-box standalone application modes. It connects via its RJ-style connector to the iDim Solo interface module.

The iDim Sense - 315 (system version) is available to provide additional functionality as PIR extension sensor and as network sensor on Helvar Digidim Toolbox and Router networks.



### iDim Solo - 403

The iDim Solo acts as a power supply as well as interface module to connect iDim Sense, DALI loads and a range of user interfaces.



### iDim Remote - 304

The iDim Remote allows the user to easily modify the preset light levels (Constant Light or Fixed Light), recall/store scenes and activate special functions such as 100hr burn-in test and PIR walk-in test.

Another use is to program advanced settings through use of USB-interface and easy-to-use PC-software. The iDim remote can also operate as a personal desktop user interface.

As an alternative solution the Digidim Remote (303) can be used in conjunction with the iDim Sense to modify the preset light levels, recall/store scenes as well as activate its specials functions (100 hr burn-in and PIR walk test).



## iDim Sense 316 (Standalone)

The iDim Sense is a luminaire based sensor. It combines a movement detector (PIR), remote control receiver (IR) and photocell (CL) in one enclosure. The manual mode selector allows the user to easily select one of the 6 out-of-box application modes.

### Key Features

- PIR, photocell (CL) and Infrared control (IR)
- Easy to select application modes
- Clip-on fascia in different colours
- Clip-on PIR restrictor
- Mode Selector with LED feedback

### Installation Notes

Multiple mounting options:

- 1) Mount from outside luminaire. "Click fit"
- 2) Mount from inside luminaire. "Bracket fit"
- 3) Combined with louvre adapter. "Adapter fit"

Isolate the mains supply before installation.

All cabling must be 230 VAC mains rated when used outside luminaire.

### Movement Detector (PIR) Coverage with Top Down View

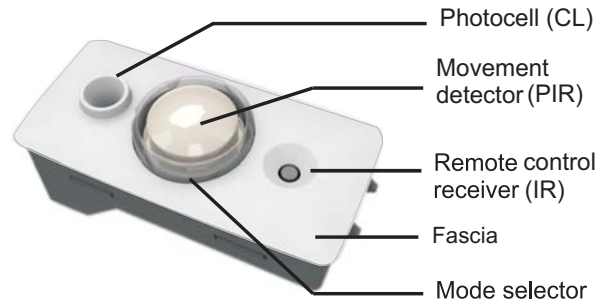
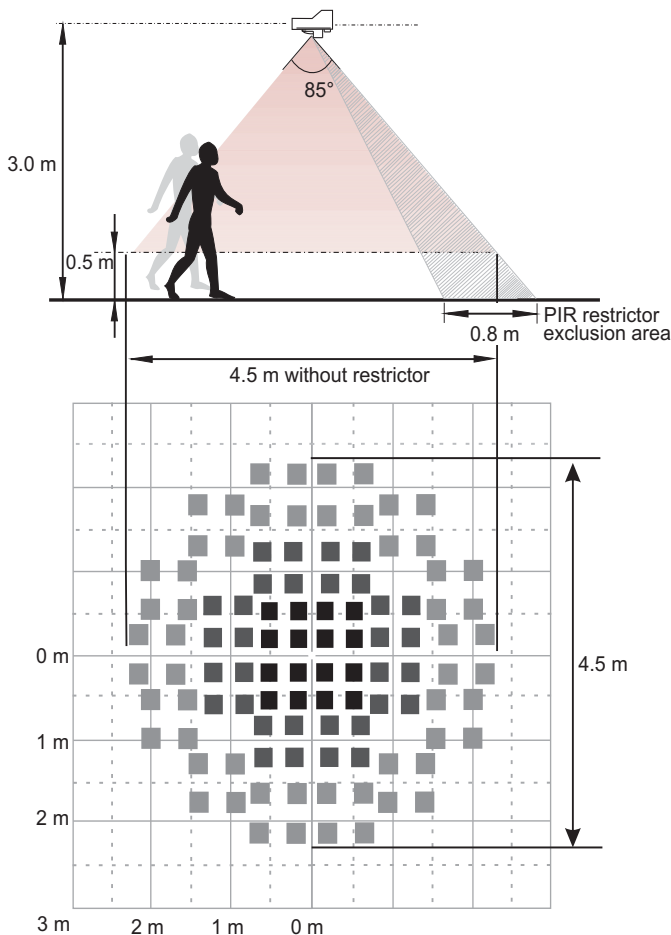

### Mounting Considerations

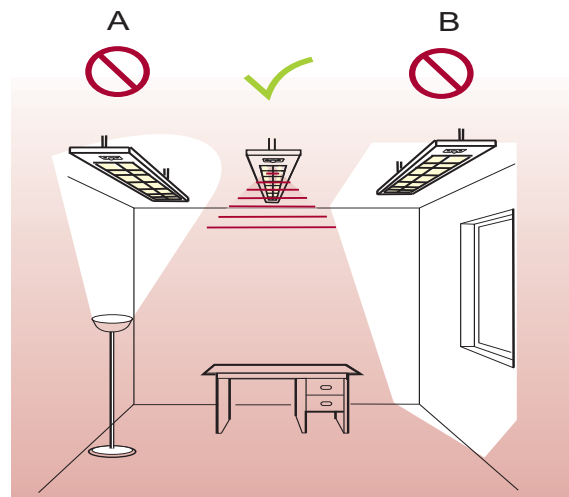

A) Do not mount sensor in direct line of artificial light sources e.g. lamps, uplighters

B) Do not mount sensor in direct sunlight

### Photocell Coverage (CL)

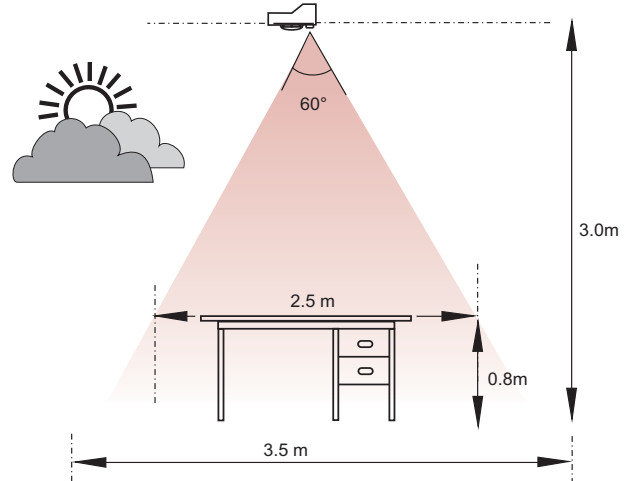

## iDim Sense 316 (Standalone)

2. Technical Data

### Connections

iDim Solo: RJ Style 4P4C crossover max. 3 m  
(accessory cable available)

DALI: 0.5 to 1.5 mm<sup>2</sup> solid, flexible  
or stranded, stripped 9 mm

**Note:** All cables must be mains rated.

### Power

DALI Consumption: 10 mA

### Operating Conditions

Relative Humidity: 90% max, non-condensing

Storage Temperature: -25°C ... +75°C

Operating Temperature: 10°C ... +50°C

Lux Level: 5 – 5000 lx

### Mechanical Data

Housing: Non flammable ABS  
(UL94-V0 & UV resistant)

Dimensions: 55 mm x 25 mm x 20 mm  
(without Fascia)

58 mm x 28.5 mm x 21.4 mm  
(with Fascia)

Weight: 15 g

Suggested Luminaire Thickness: 0.6 mm to 2.4 mm

### Colour

- iDim Sense: White (RAL 9016)

- iDim Fascia: White (RAL 9016) or Grey (RAL 9006)

**Note:** Contact Helvar for additional Fascia colour options.

### Conformity & Standards

DALI: According to DALI standard,  
with Helvar extensions.

### EMC

Emission: EN 55 015

Immunity: EN 61 547

Safety: EN 61 347-2-11

Isolation: Double isolated

### Environment

Complies with WEEE and RoHS directives.

### Connections

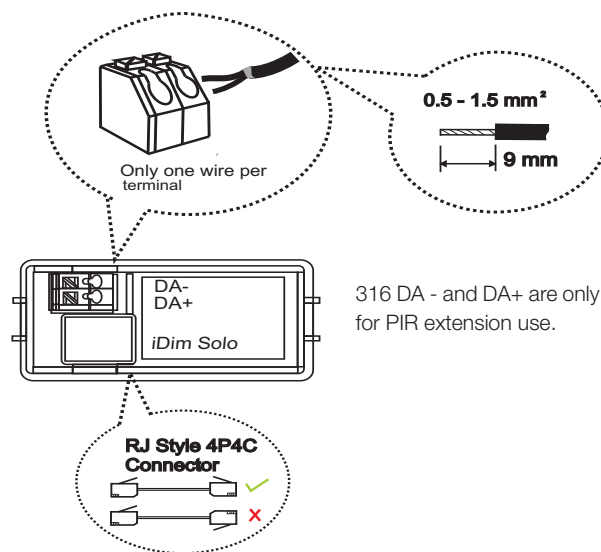

316 DA - and DA+ are only for PIR extension use.

### Dimensions

iDim Sense without Fascia

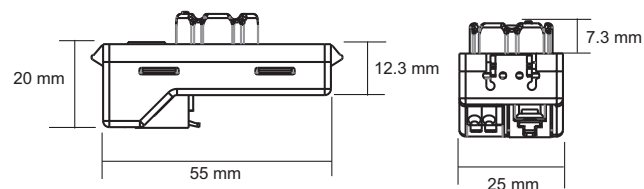

iDim Sense with Fascia

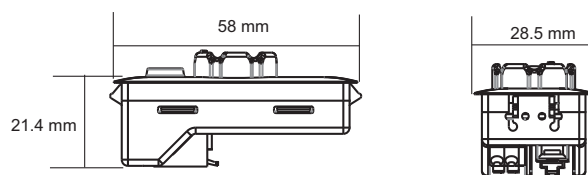

Movement detector (PIR), remote control receiver (IR) and photocell (CL) dimensions

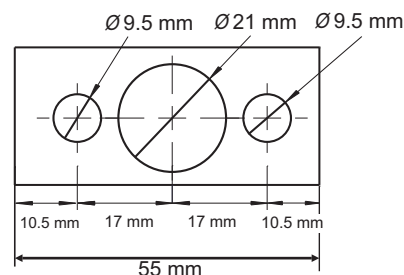

## iDim Solo 403 (Interface Module)

The iDim Solo is used as an interface module to connect the iDim Sense (316 Standalone) and iDim ballasts as well as user interfaces. Additionally, the iDim Solo can be used as a DALI power supply unit (PSU).

The unit is housed in a standard ballast-style enclosure (30 m width x 21 mm height) making it easy to assemble.

### Key Features

- Power capability: 64 mA (DALI 1), 32 mA (DALI 2) or 96 mA when operating in parallel
- 2 x DALI outputs
- 2 x Switch control inputs
- iDim Sense connection (RJ style, 4P4C)
- Mains connection

### Installation Notes

- All cabling must be 230 VAC mains rated and considered live when operating outside luminaire
- Isolate the mains supply before installation
- The external mains supply to the unit must be protected.
- Install in a restricted access location only, e.g. luminaire housing



2. Technical Data

### iDim Solo as Interface Module

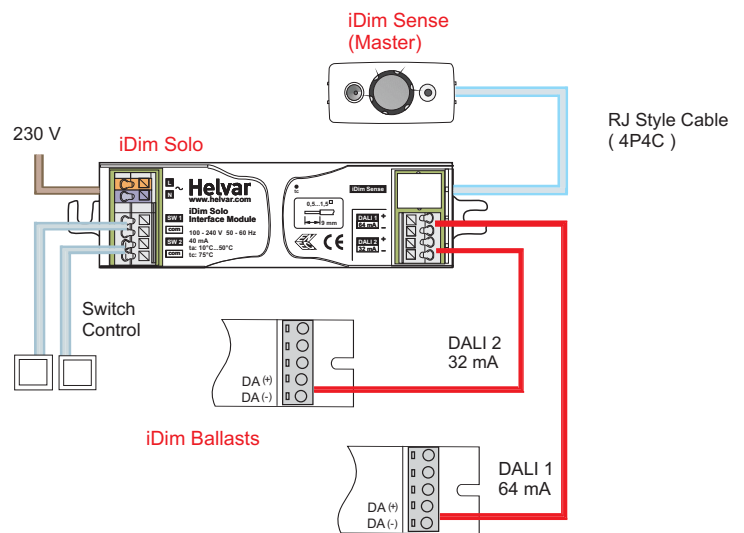

### iDim Solo as a Power Supply Unit (PSU)

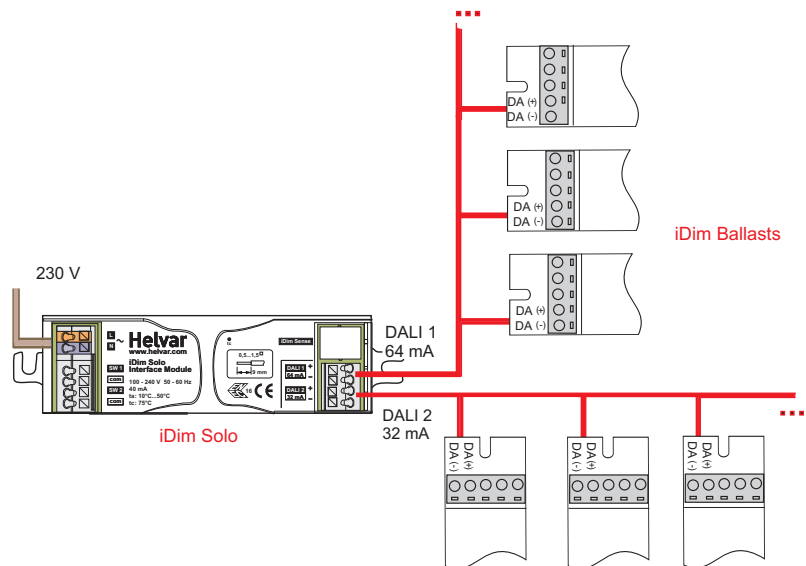

## iDim Solo 403 (Interface Module)

### Connections

Mains/DALI /Switch Control: 0.5 to 1.5 mm<sup>2</sup> solid, flexible, or stranded, stripped 9 mm

iDim Solo Control: RJ style 4P4C crossover (max. length 3 m) (accessory cable available)

**Note:** All cables must be mains rated.

### Power

Mains Supply for: 100-240 VAC, 50-60Hz  
 Mains Supply (absolute): 85-264 VAC, 45-65 Hz  
 Supply Current: 40 mA  
 Protection: Internally resettable fuse (PTC)

### Inputs

Override input: 2 x Switch Control. Max. 50 m (For use with iDim Sense 316)

### Outputs

2 x DALI outputs  
 DALI 1: 64 mA  
 DALI 2: 32 mA

### Operating Conditions

Relative Humidity: 90% max, non-condensing  
 Storage Temperature: -25°C ...+75°C  
 Operating Temperature: 10°C ... +50°C

### Mechanical Data

Housing: Non flammable Polycarbonate (UL94-V0 & UV resistant)  
 Dimensions: 121 mm x 30 mm x 21 mm (incl. screw clips)  
 Weight: 40 g  
 Colour: White (RAL 9016)

### Conformity & Standards

DALI: According to DALI standard.

### EMC

Emission: EN 55 015  
 Immunity: EN 61 547  
 Safety: EN 61 347-2-11  
 Isolation: 4 kV

### Environment

Complies with WEEE and RoHS directives.

### Connections

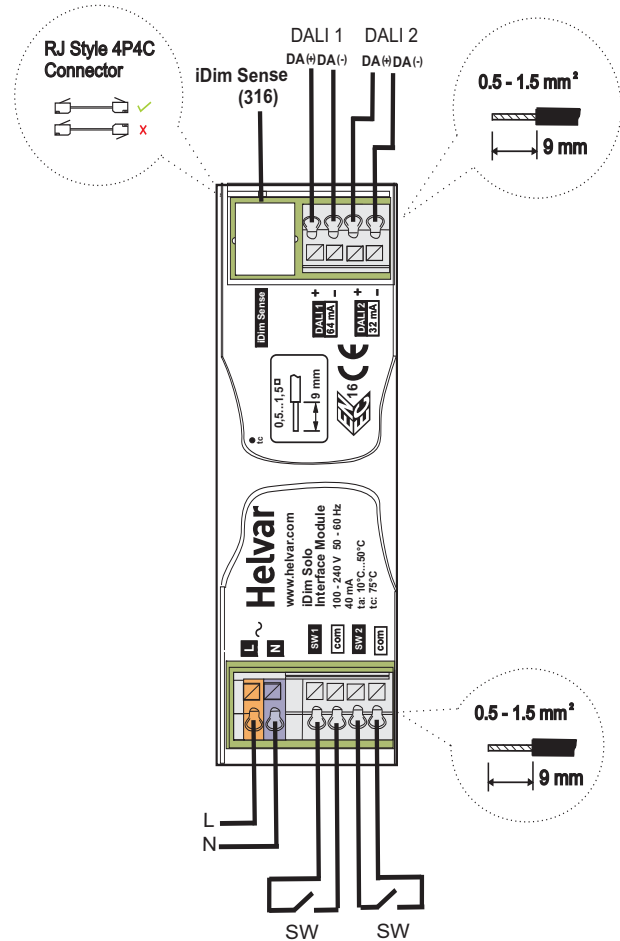

### Dimensions

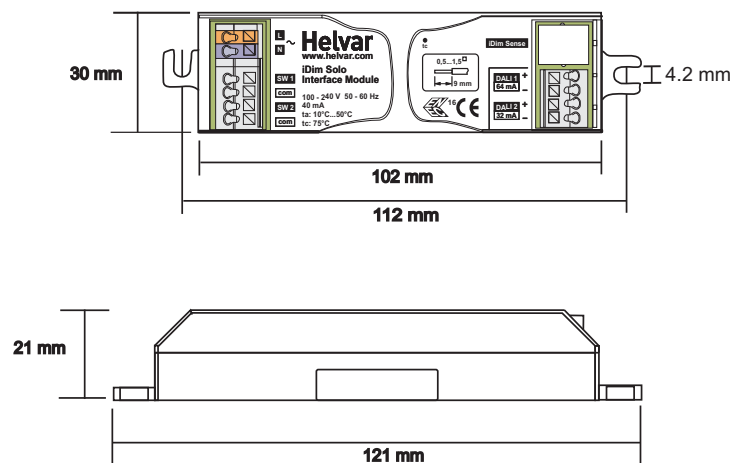

## iDim Physical Installation

Below you will find the recommended methods for installing the iDim Sense and Solo into your luminaire.

### 3.1 iDim Sense Installation

There are 3 possible ways for mounting the iDim Sense to the luminaire.

#### External Mounting

1. Cut opening in luminaire 56.5 x 26 mm +/- 0.25 mm.
2. Click Fascia to iDim Sense.
3. Click iDim Sense into luminaire.

**Note:** Opening dimensions are applicable for a luminaire with a housing thickness of 0.6 mm to 2.4 mm max.

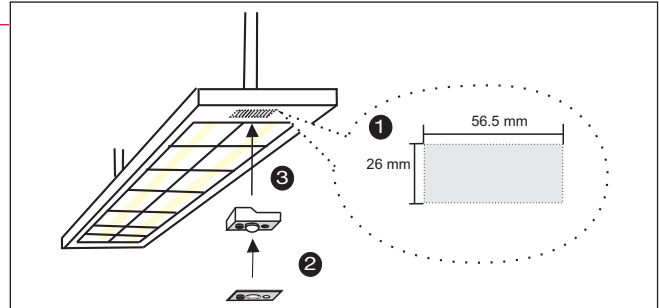

#### Fabricate Louvre Adapter

1. Fabricate a louvre adapter to fit at either end of the luminaire. (Opening dimensions: 56.5 x 26 mm +/- 0.25 mm).
2. Click iDim Sense into louvre adapter opening.
3. Fit complete assembly to louvre.

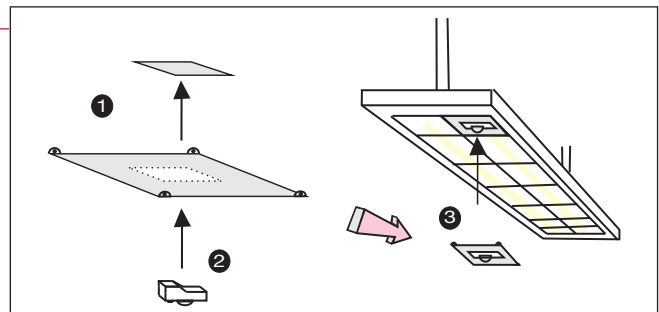

#### Internal Mounting

1. Cut three holes in the luminaire. (See adjacent diagram for dimensions).
2. Insert iDim Sense from inside the luminaire.
3. Fabricate a bracket to secure iDim Sense in place.

**Note:** Fascia not required when mounting the iDim Sense internally.

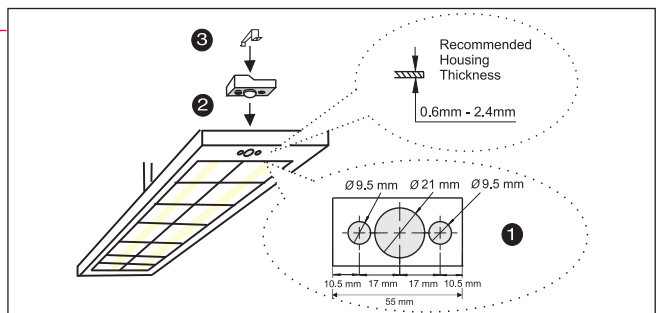

### 3.2 iDim Solo Installation

Use these screw types when mounting the iDim Solo:

- Pan head Machine Screw M4
- Pan head Self Tapping Screw No. 8

**Note:** Countersunk screws should not be used.

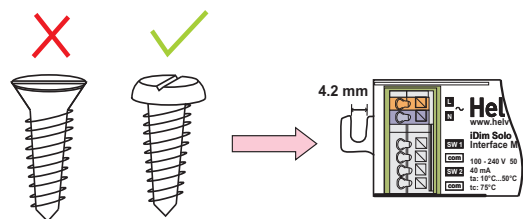

### 3.3 Mounting the optional PIR Restrictor

1. Select a mode before mounting PIR restrictor.
2. Position PIR restrictor to cover the area to be hidden.
3. Push PIR restrictor over the mode selector.

**Note:** Do NOT adjust PIR restrictor while it is attached to the iDim Sense.

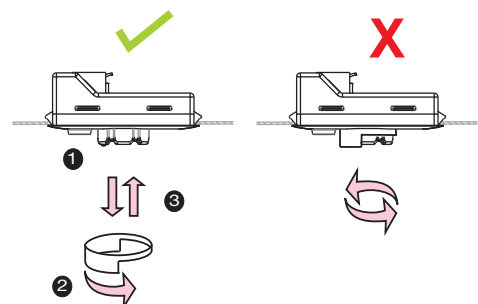

## Connections

### Cable Requirements

**Note 1:** DALI cable must be mains-rated and the maximum voltage drop along the length of the cable must not exceed 2 V.

**Note 2:** RJ cabling used outside of luminaire fitting must be mains rated. Use, Alpha 1174C or 6642.

Connection	Cable Type	Cable Length
iDim Solo DALI	1.0 mm <sup>2</sup> to 1.5 mm <sup>2</sup> (recommended)	max. 300 m @ 1.5 mm <sup>2</sup>
iDim Sense (316 Standalone)	RJ style 4P4C connector (crossover)	max. 3 m between iDim Solo and iDim Sense
Switch Control	0.5 mm <sup>2</sup> to 1.5 mm <sup>2</sup> (recommended)	max. 50 m
Mains Supply Cable	0.5 mm <sup>2</sup> to 1.5 mm <sup>2</sup>	-

## Connection Methods

**Important!** iDim Solos contain DALI power supplies and therefore must always be connected DA+ to DA+ and DA- to DA-.

### 4.1 iDim Standalone

- The adjacent diagram shows the iDim Sense (316), iDim Solo and iDim ballasts connected as a basic standalone system.

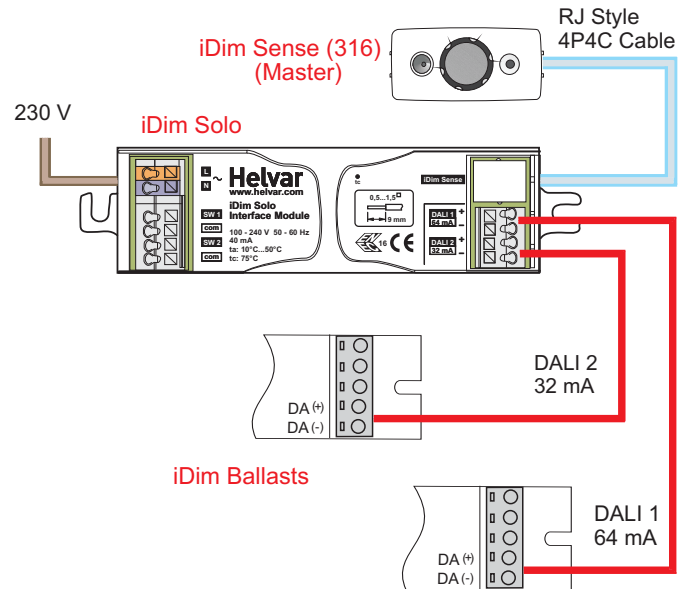

### 4.2 iDim Networked

**Important!** Only available with iDim Sense 315.

- The adjacent diagram shows the iDim Sense 315 (system) connected directly to a Helvar 910/920 router via the push wire DALI connectors located on the reverse of the device.
- iDim Sense 315 can also be used in conjunction with Helvar Digidim Toolbox systems.
- Using the iDim Sense 315 with a 910 or 920 router will cause the iDim Sense mode selector to be ignored. All configuration is done via Designer software where the iDim Sense 315 behaves like a 312 Multisensor.

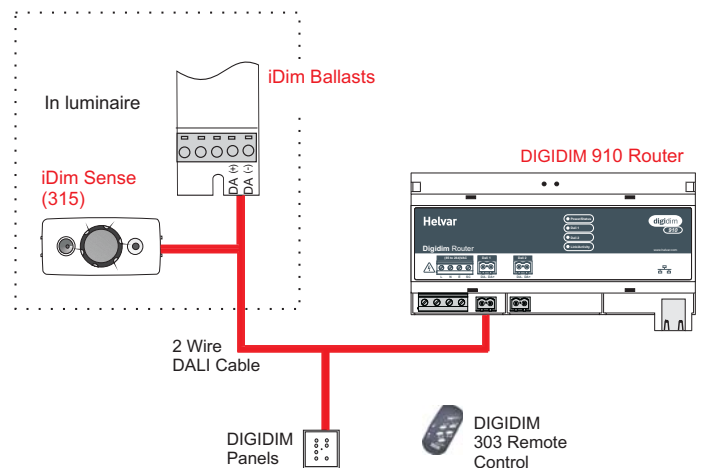



## Connections

### 4.3 iDim Solo as a PSU

- The adjacent diagram shows the iDim Solo working as a PSU.
- Outputs are paralleled to provide 96 mA of power.
- RJ 4P4C Connector and Switch Inputs are **not** used when iDim Solo operates as a DALI power supply.

**Note:** For maximum number of ballasts see manufacturer data.

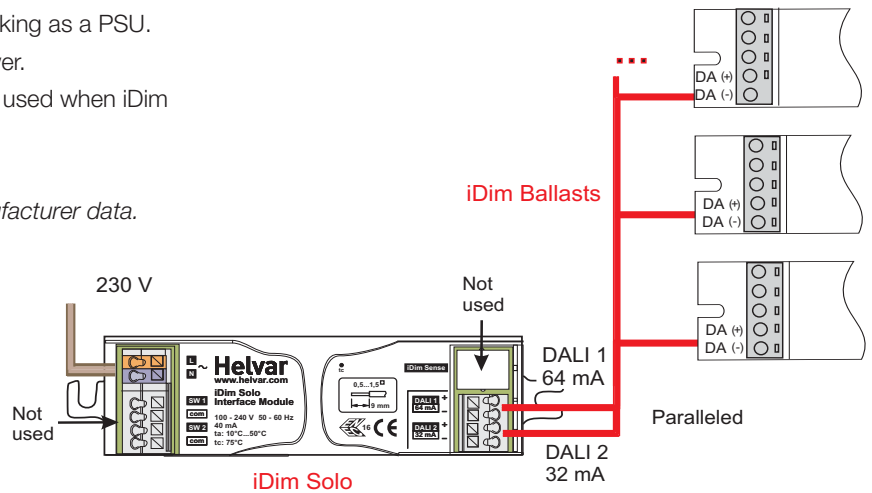



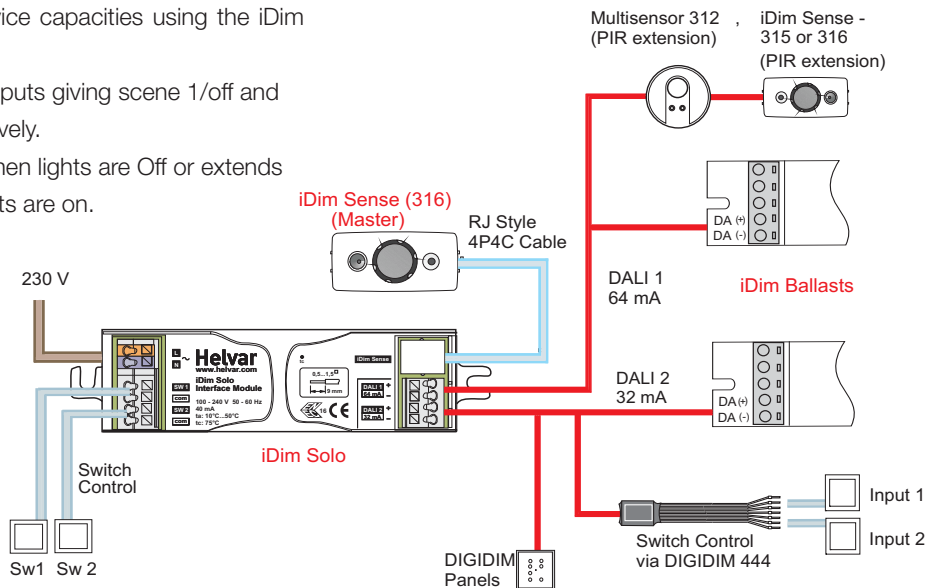

### 4.4 Device Combinations

- The adjacent diagram shows all possible device combinations.
- See table 1 for possible system device capacities using the iDim Sense and Solo.
- SW1 and SW 2, are switch-control inputs giving scene 1/off and level control of DALI 1 and 2 respectively.
- PIR movement generates scene 1 when lights are Off or extends the scene already selected when lights are on.



**Table 1:** iDim Sense and iDim Solo device capacity combinations.

iDim Sense 316 (Master) + iDim Solo	iDim ballast 2 mA	Ceiling multisensor (PIR extension) 15 mA	iDim Sense 315 or 316 (PIR extension) 10 mA	DIGIDIM button panel 10 mA
				
<b>DALI 1 (64 mA -10 mA)**</b>	up to 27 *	up to 3 *	up to 5 *	up to 5 *
<b>DALI 2 (32 mA)</b>	up to 16 *	up to 2 *	up to 3 *	up to 3 *

\* The total number of devices depends on the overall combination.

\*\* 10 mA is consumed by one iDim Sense Master unit.

iDim Solos contain power supplies. Always ensure you do not exceed a current of 250 mA on any DALI connection.

## Mode Selection

There are 6 default modes which can be set by turning the mode selector located on the sensor unit.

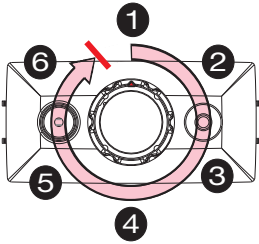

- 1) To locate mode 1 (Classroom mode), rotate the mode selector counterclockwise until it stops.
- 2) If changing modes during power on - the red LED will blink 1 to 6 times to indicate mode selected.

**Note:** Please ensure that the PIR restrictor is not attached to the iDim Sense during mode selection.

**Table 2:** Default iDim configuration:

		CLASS-ROOM	SINGLE OFFICE	OPEN PLAN OFFICE	CORRIDOR LINK	CORRIDOR HOLD	MEETING ROOM
TIMING & LEVEL	Occupancy Timeout	15 min	15 min	15 min	5 min	15 min	15 min
	Transition Timeout (level)	1 min (20 %)	1 min (20 %)	60 min (20 %)	30 min (20 %)	1 min (20 %)	1 min (20 %)
BRIGHT OUT	When On	✓	✓	✓	✓	✓	✓
	When Off	✓	✓	✓	✓	✓	✓
PRESENCE	Enabled / Disabled	Disabled Manual On	Enabled Auto On	Enabled Auto On	Enabled Auto On	Enabled Auto On	Disabled Manual On
ABSENCE	Enabled / Disabled	Enabled Auto Off	Enabled Auto Off	Enabled Auto Off	Enabled Auto Off	Enabled Auto Off	Enabled Auto Off
iDim Controller Scene 1	DALI 1	CL <sup>1</sup>	CL <sup>1</sup>	CL <sup>1</sup>	FL (100%) <sup>1</sup>	CL	CL
	DALI 2	Offset <sup>1</sup>	Offset <sup>1</sup>	Offset <sup>1</sup>	FL (100%) <sup>1</sup>	Link to Corridor <sup>2</sup>	See notes below <sup>3</sup>
iDim Controller Scene 2	DALI 1	CL <sup>1</sup>	CL <sup>1</sup>	CL <sup>1</sup>	FL (70%) <sup>1</sup>	CL	-
	DALI 2	Offset <sup>1</sup>	Offset <sup>1</sup>	Offset <sup>1</sup>	FL (70%) <sup>1</sup>	Link to Corridor <sup>2</sup>	FL (100%)
iDim Controller Scene 3	DALI 1	FL (100%)	FL (100%)	FL (100%)	FL (40%) <sup>1</sup>	FL (100%)	-
	DALI 2	FL (100%)	FL (100%)	FL (100%)	FL (40%) <sup>1</sup>	Link to Corridor <sup>2</sup>	FL (0%)
iDim Controller Scene 4	DALI 1	FL (40%)	FL (40%)	FL (40%)	FL (10%) <sup>1</sup>	FL (40%)	FL (40%)
	DALI 2	FL (40%)	FL (40%)	FL (40%)	FL (10%) <sup>1</sup>	Link to Corridor <sup>2</sup>	FL (20%)

**Table Information:**

In this table 'iDim Controller' refers to Remote Control, Switches and Panels unless specified.

<sup>1</sup> iDim Solo SW1 and SW 2 are switch-control inputs. In modes where DALI 2 is "offset" from DALI 1 and in Corridor Hold mode, they control the level of both DALI 1 and DALI 2.

<sup>2</sup> In Corridor Hold (Mode 5) DALI 2 is only used to connect an office to the corridor.

<sup>3</sup> In Meeting Room (Mode 6), iDim Solo SW1 input operates DALI 1 CL / Off and SW2 input operates DALI 2 FL (100%) / Off. As SW1 is located at the entrance of a room, switching off SW1 will cause both DALI 1 and DALI 2 circuits to go off.

**General Information:**

- Long key presses of a controller give Up / Down level control of DALI 1 and DALI 2. They operate independently except when in CL + Offset scenes where they operate together.
- Short key presses of a switch give Scene 1 / Off control of DALI 1 and DALI 2 together except in Meeting Room (Mode 6). (Refer to point 3 above).

## Mode Selection

The following settings can be modified using the Helvar iDim Studio software:

**Occupancy Timeout:** Time when PIR detects no movement and maintains level before moving to transition timeout (e.g. 15 mins).

**Transition Timeout:** Lights are lowered to energy saving level for a specific time before switching off (e.g. 60 secs).

For example:

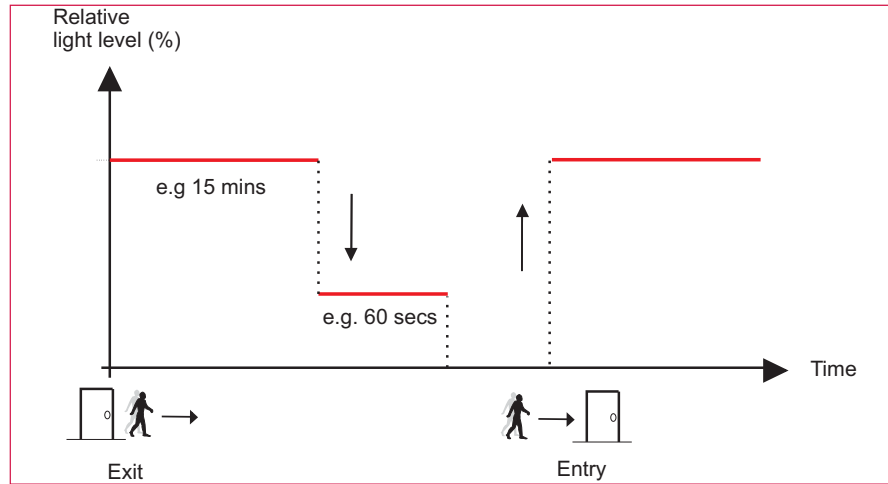

**Presence:** Presence Detection enables PIR movement to switch on lights. This function can be either enabled or disabled.

**Absence:** Absence Detection enables automatic switch off of lights. This function can be either enabled or disabled.

**iDim Remote / Controller Scenes 1 - 4:** DALI 1 and DALI 2 outputs operate as a combination of Constant Light (CL), Fixed Light (FL) and Offset. These terms are discussed in greater detail below. The Constant Light and Fixed Light level settings can be modified using the iDim Remote Control or a DIGIDIM button panel. *For further information on these settings please see iDim Remote User Manual (D004744).*

### Constant Light

Constant Light (CL) is a method of automatically controlling the level of the system's lights by utilising the natural light of an area and adapting the light level accordingly. This setting is configurable using the iDim Remote however it is important to remember constant light should always be configured in a darkened room or at dusk to avoid natural light affecting the configuration of the target level.

### Fixed Light

Fixed Light is where the load output is NOT adjusted by the Light Sensor. Lights will remain at a certain level unless altered.

### Offset

The Offset figure is the difference between DALI 1 and DALI 2. When working with CL, the offset amount will maintain the level difference no matter how lighting conditions change.

### Constant Light (CL) & Fixed Light (FL)

The adjacent example shows DALI 2 operating with Fixed Light settings. Only DALI 1 (Constant Light) levels increase/decrease subject to natural light changes.

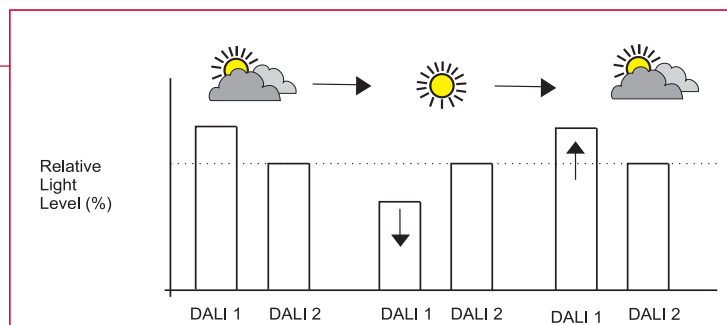

## Mode Selection

### Constant Light (CL) & Offset

The adjacent example shows the default Offset of 20%. When more natural light is detected by the Constant Light sensor, DALI 2 (Offset) will lower the light level at the same rate as DALI 1 (CL) while maintaining the 20% gap.

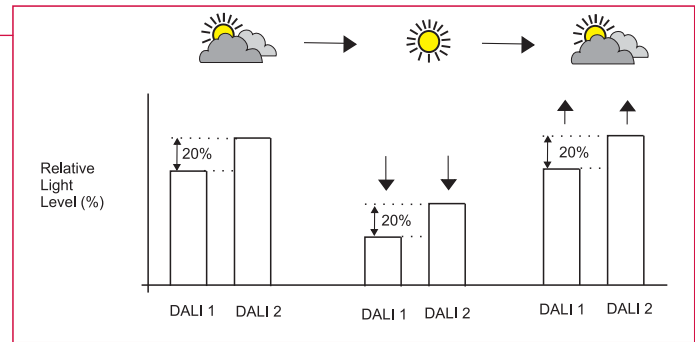

### Bright Out

Bright out is an optional feature of constant light operation that allows further energy saving by reducing light level during times of adequate natural light. By default, bright out settings for all preset iDim modes are enabled. Bright out settings can be either enabled or disabled in iDim Studio.

- **Bright Out - When Off:** If lights are off and there is enough natural light, the lights will go to power save level (default 10%) when switched on.
- **Bright Out - When On:** If lights are on and there is enough natural light, the lights will reduce to power save level after 10 mins.
- **Bright out - Upper threshold:** Specific threshold above the target light level. Configurable using iDim Studio software.
- **Bright out - Lower threshold:** Specific threshold below the target light level. Configurable using iDim Studio software.

For example:

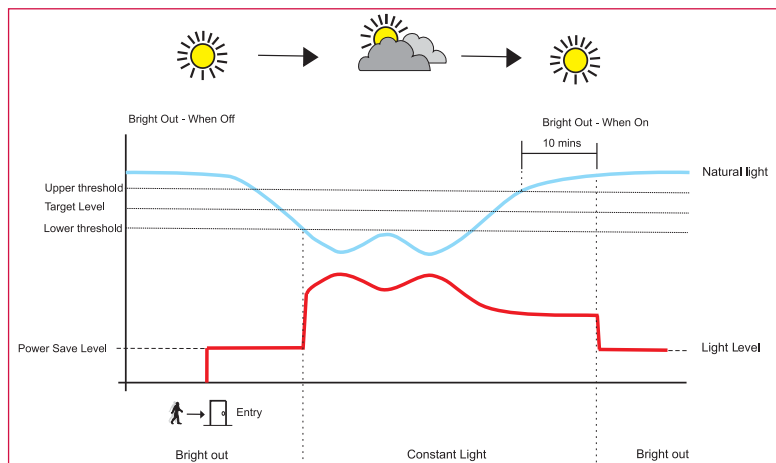

**Note:** If the light level is ever less than the power save level then it will stay at the lower level and not go to the power save level.

If necessary, the power save level can be set to off (0%) via iDim Studio Editor.

When scene is selected/triggered: Lights go to power save level (10% by default) if natural light is above the upper level threshold. If light level goes below the lower level threshold then the lights revert to Constant Light.

When scene is already selected: Lights reduce to power save level if natural light is above the upper level threshold for more than 10 minutes. If the light level goes below the lower level threshold then the lights revert to Constant Light.

### Power Up Procedure

When lights are powered up they will go to 100% for 5 minutes. If there is no PIR movement within this time they will go off (0%). If movement is detected anytime during this period then the system will start to operate as normal. As this is a standard safety feature it is NOT configurable in iDim Studio.

### User Defined Mode

iDim Sense enters User Defined Mode as soon as scenes and settings are stored via the iDim Remote Control.

When in User Defined Mode the iDim Sense Mode Selector ring will be ignored.



To leave User Defined Mode and reset to default settings at any time, hold **button 3 + 4** on the Remote for 10 seconds.



## Typical Mode Setup

Please see below for **suggested** installation methods for each of the six modes.

**Note:** The following modes show DALI 1 and DALI 2 when scene 1 is selected. See table 2 on page 10 for further information.

Key:

*iDim Sense* 
 Panels:  (Switch) or  (7 button panel)

*iDim Solo* 
*iDim Ballasts* 
*iDim Remote Control* 

### 6.1 Classroom Setup (Mode 1)

Presence Detection : Disabled, Absence Checking : Enabled, Bright Out : Enabled, Occupancy Timeout : 15 minutes, Transition : 60 seconds @ 20% , Exit delay : 90 seconds

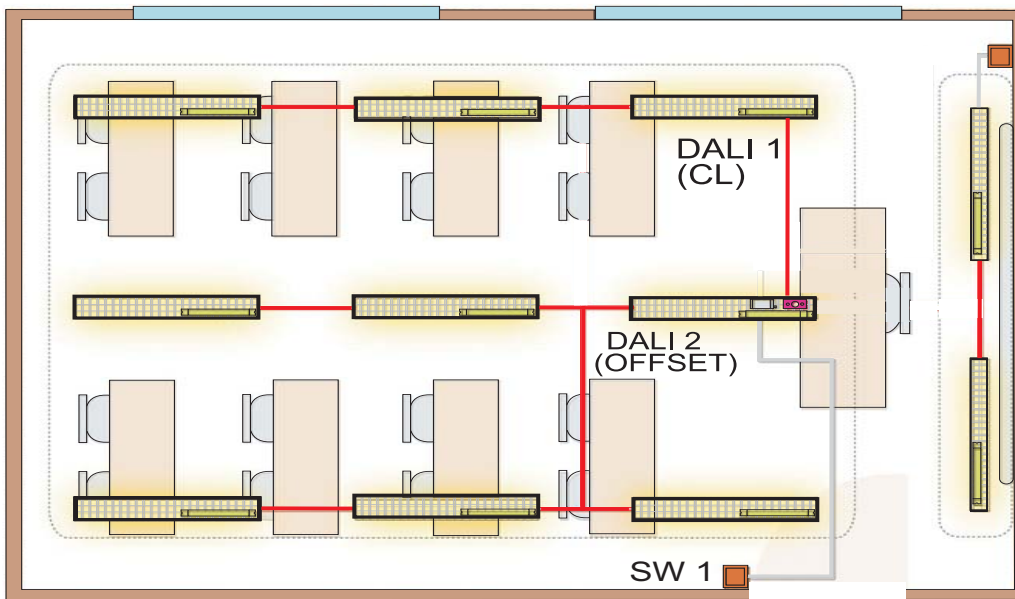

**Note:** For an alternative classroom setup please refer to 6.6 Meeting Room (Alternative Classroom).

### 6.2 Single Office Setup (Mode 2)

Presence Detection : Enabled, Absence Checking : Enabled, Bright Out : Enabled, Occupancy Timeout : 15 minutes, Transition : 60 seconds @ 20% , Exit delay : 90 seconds

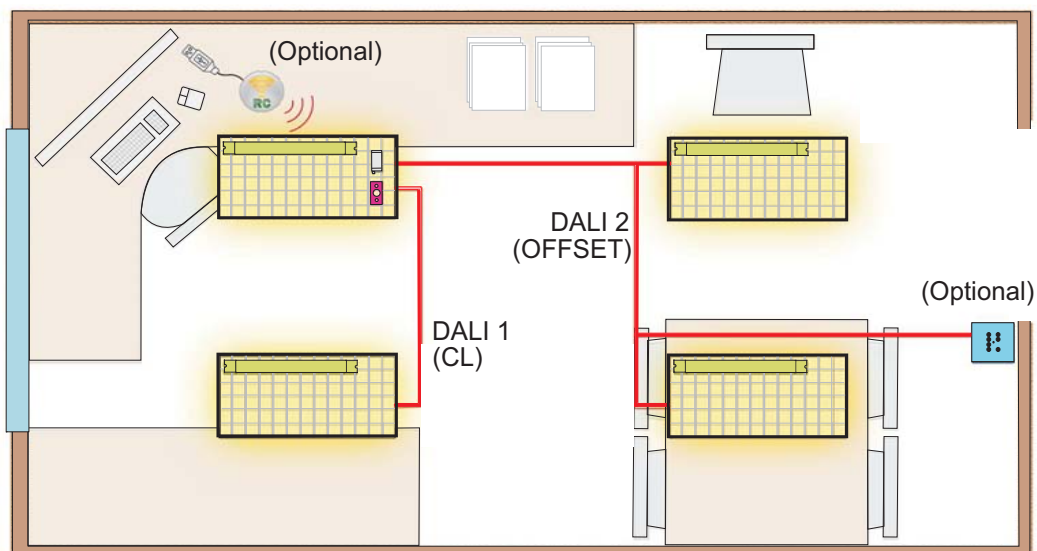

## Typical Mode Setup

### 6.3 Open Plan Office Setup (Mode 3)

Presence Detection : Enabled, Absence Checking : Enabled, Bright Out : Enabled, Occupancy Timeout : 15 minutes, Transition : 60 minutes @ 20% , Exit delay : 90 seconds

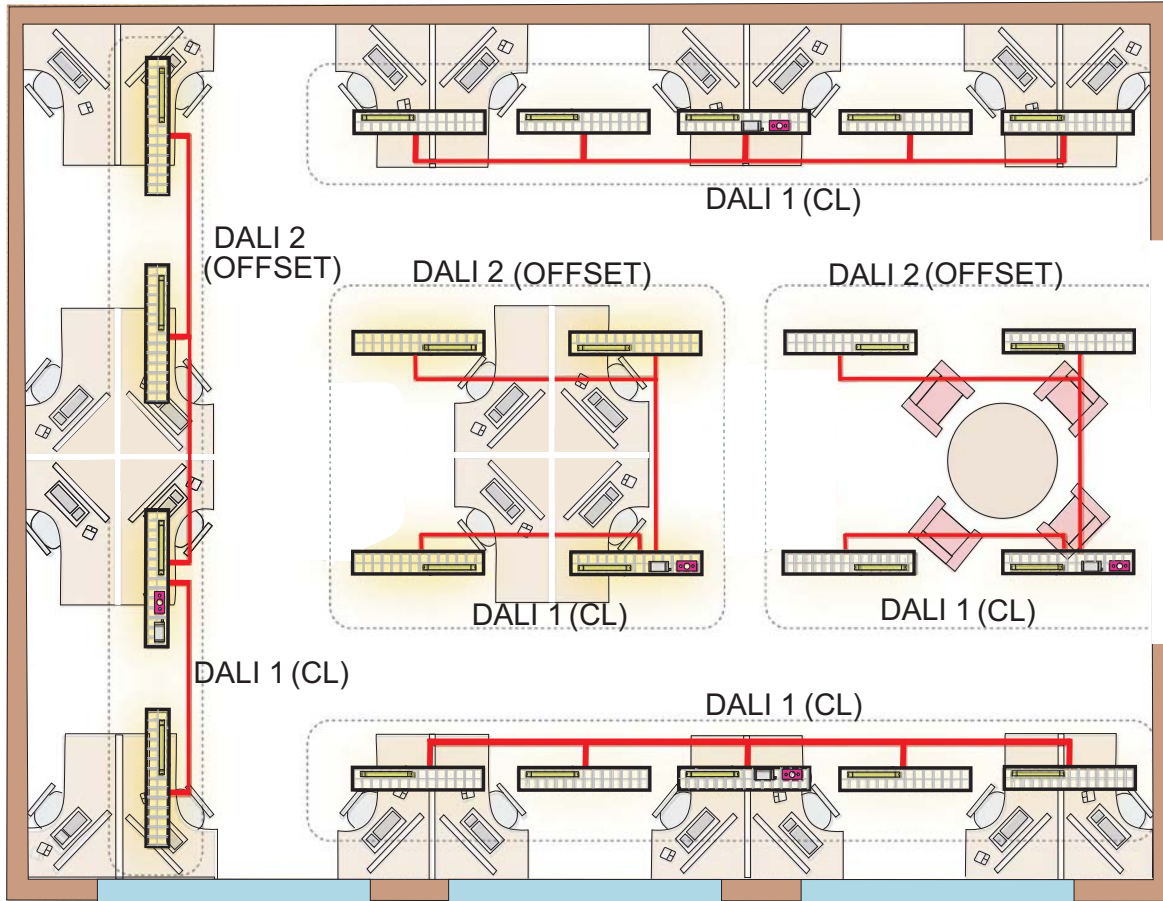

6. Mode Setup

### 6.4 Corridor Link Setup (Mode 4)

Presence Detection : Enabled, Absence Checking : Enabled, Bright Out : Enabled, Occupancy Timeout : 5 minutes, Transition : 30 minutes @ 20% , Exit delay : 90 seconds

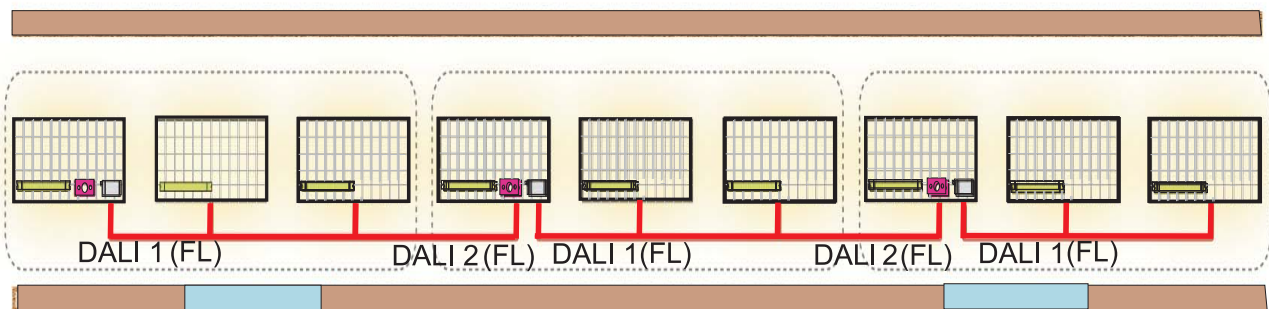

**Note:** The corridor is wired DALI (1 or 2) to DALI (1 or 2) along the corridor. Corridor loads and controls can be connected to either DALI output. The contributing iDim Solo supplies must not exceed 250 mA on any DALI connection.

iDim Solos contain DALI power supplies and therefore must always be connected DA+ to DA+ and DA- to DA-.

## Typical Mode Setup

### 6.5 Corridor Hold Setup



(Mode 5) +



(Mode 4 for corridor wiring)

Presence Detection : Enabled, Absence Checking : Enabled, Bright Out : Enabled, Occupancy Timeout : 15 minutes, Transition : 60 seconds @ 20% , Exit delay : 90 seconds

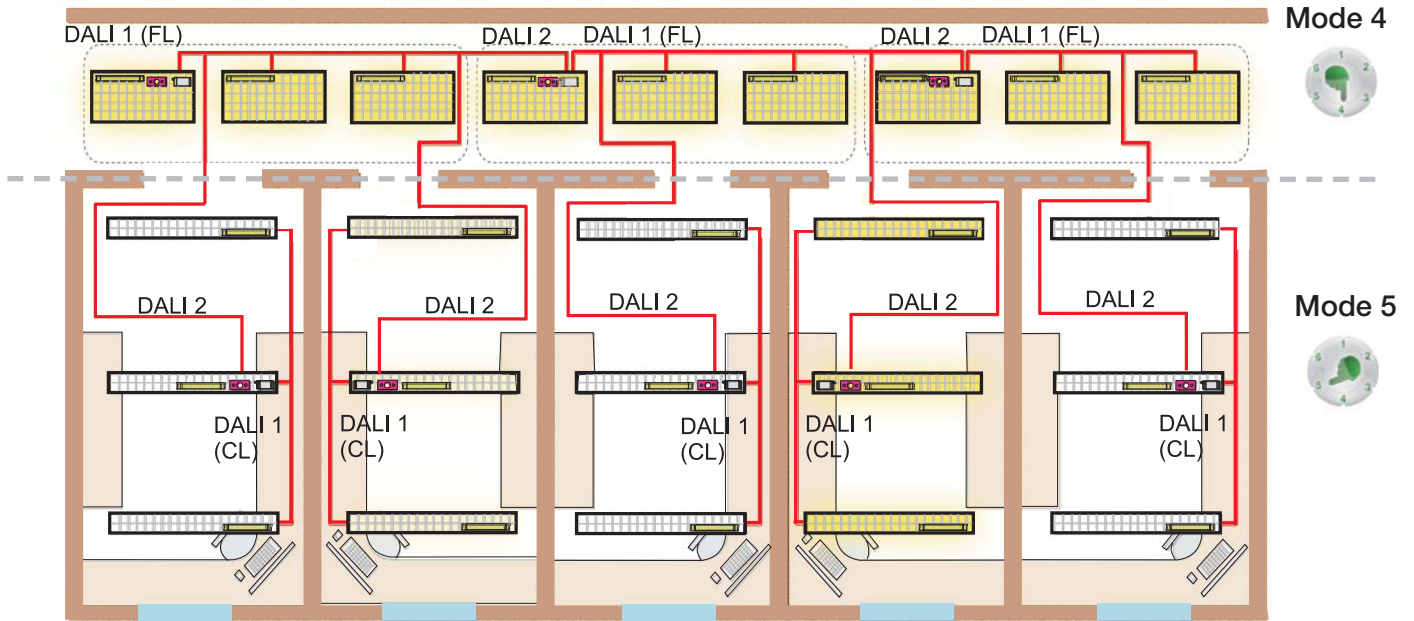

**Note:** The corridor will remain lit when any of the lights are on in single cell offices.

Office loads and controls must be connected to the DALI 1 output (64 mA current limit - limited by Solo DALI 1 supply).

The DALI 2 output is **only** for connection from the office to the corridor.

iDim Solos contain DALI power supplies and therefore must always be connected DA+ to DA+ and DA- to DA-.

### 6.6 Meeting Room (Alternative Classroom)



(Mode 6)

Presence Detection : Disabled, Absence Checking : Enabled, Bright Out : Enabled, Occupancy Timeout : 15 minutes, Transition : 60 seconds @ 20% , Exit delay : 90 seconds

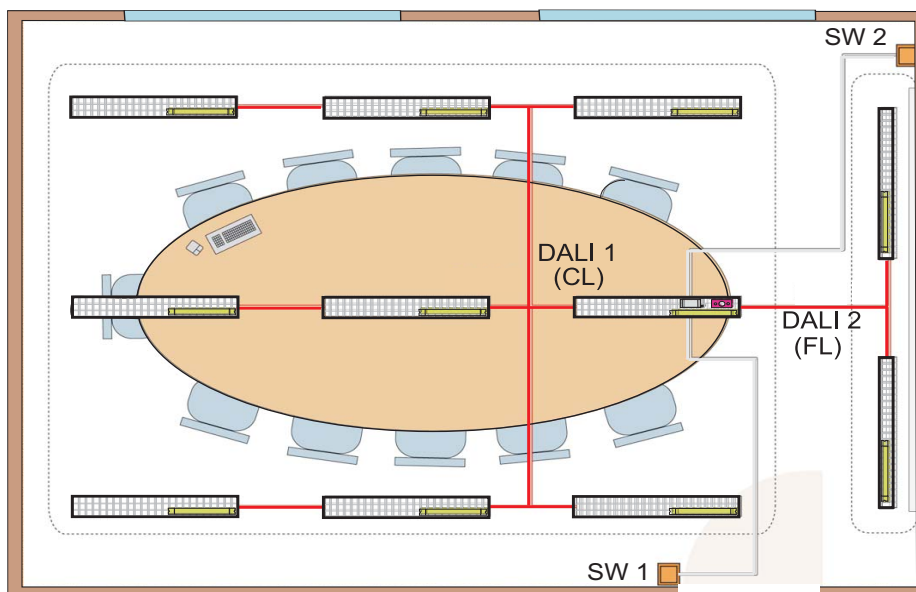

**Note:** iDim Solo SW1 input operates DALI 1 CL / Off and SW2 input operates DALI 2 FL (100%) / Off.

As SW1 is located at the entrance of a room, switching off SW1 will cause both DALI 1 and DALI 2 circuits to go off.

## LED Feedback

The iDim Sense contains 2 LEDs, red and green, that provide user feedback for different functions.

Function	LED Flash Feedback	
	Mode Unmodified	User Defined Mode Selected*
<b>Mode 1 Selected</b> (Classroom Mode)		
<b>Mode 2 Selected</b> (Single Office)		
<b>Mode 3 Selected</b> (Open Plan Office)		
<b>Mode 4 Selected</b> (Corridor Link)		
<b>Mode 5 Selected</b> (Corridor Hold)		
<b>Mode 6 Selected</b> (Meeting Room)		
<b>PIR Walk Test Mode</b> Sequence repeats until walk test is complete.	...	
<b>100 hour Burn-In Mode</b> Sequence repeats until burn-in is complete.	30 sec  30 sec  ...	
<b>DALI Errors</b> Sequence repeats until error clears.	...	
<b>Change from unoccupied to occupied</b> Typically follows a PIR detection.		
<b>Data received from IR Remote</b>		
<b>Enabling / Disabling of IR Receiver</b>		
<b>Successful Scene Store</b>		
<b>Failed Scene Store</b>		
<b>Successful Upload from IR Remote</b>		
<b>Failed Upload from IR Remote</b>		

Note: iDim Sense LED feedback flashes apply to all iDim units of v5.3 and onwards

\* To leave User Defined mode and reset iDim Sense to default settings at any time, hold button 3 + 4 on the iDim Remote Control for 10 seconds while the remote is in 'Special function mode'. See page 6 - 8 for information.



## Ordering Information

A large selection of accessories can be used in conjunction with the iDim family to support your individual lighting needs.

### Sensors & Interface Module



**312 Multisensor**  
(PIR extension only)



**315 iDim Sense**  
(System & Standalone)



**316 iDim Sense**  
(Standalone)



**403 iDim Solo**  
(Interface Module)

### User Interfaces



**304 iDim Remote**  
Dedicated iDim remote featuring USB port for advanced settings and PC desktop control.



**Digidim 'iDim Ready' Panels**  
121, 122, 124, 125, 126



**Digidim 303 IR Remote Control.**  
Standard remote control to modify target light levels, scene recall / store and recall test functions.

### Accessories



**50630 iDim Cable (Pack of 30)**  
50cm RJ-style cable  
(4P4C crossover)



**iDim Fascia**  
white or grey supplied as standard with iDim Sense - other colours optional.



**Digidim 444 Mini Input Unit**

### Software



**iDim Demonstrator**  
Freeware to simulate the iDim standalone system operation for training purposes.



**iDim Studio Editor**  
Freeware that allows to create either graphical user interface applets for the iDim Remote, or modify advanced iDim system settings.

For detailed information about all Helvar products, please visit [www.helvar.com](http://www.helvar.com).

Product Code	Description	Package Dimensions
315	Single packaged iDim Sense (System & Standalone), including white and grey fascia and PIR restrictor.	65 mm x 34 mm x 30 mm
316	Single packaged iDim Sense (Standalone), including white and grey fascia and PIR restrictor.	65 mm x 34 mm x 30 mm
31630W	Tray of 30 pieces non-packaged iDim Sense (Standalone), including 30 pieces <b>white</b> fascia and PIR restrictor.	395 mm x 232 mm x 52 mm
31630G	Tray of 30 pieces non-packaged iDim Sense (Standalone), including 30 pieces <b>grey</b> fascia and PIR restrictor.	395 mm x 232 mm x 52 mm
403	Single packaged iDim Solo Interface Module.	123 mm x 32 mm x 22 mm
40330	Tray of 30 pieces non-packaged iDim Solo Interface Modules.	367 mm x 309 mm x 30 mm
50630	Set of 30 pieces iDim Cable, RJ-style connectors (4P4C) each 500mm length.	-

Helvar Ltd  
Hawley Mill  
Hawley Road  
Dartford, Kent (UK)  
DA2 7SY  
Fax: +44 (0)1322 282 216  
[www.helvar.com](http://www.helvar.com)

UK: +44 1322 222 211  
FI: +358 9 56 54 1  
SE: +46 8 545 239 70  
FR: +33 1 3418 1281  
IT: +39 02 55 30 10 33  
DE: +49 6104 78075 0  
RU: +7 (495) 728 82 91  
HU: +36 1 2393 136

Product: iDim Sense & Solo User Manual  
Doc No. D004735  
Issue 4

***Data subject to change without notice***