

Installation and User Guide

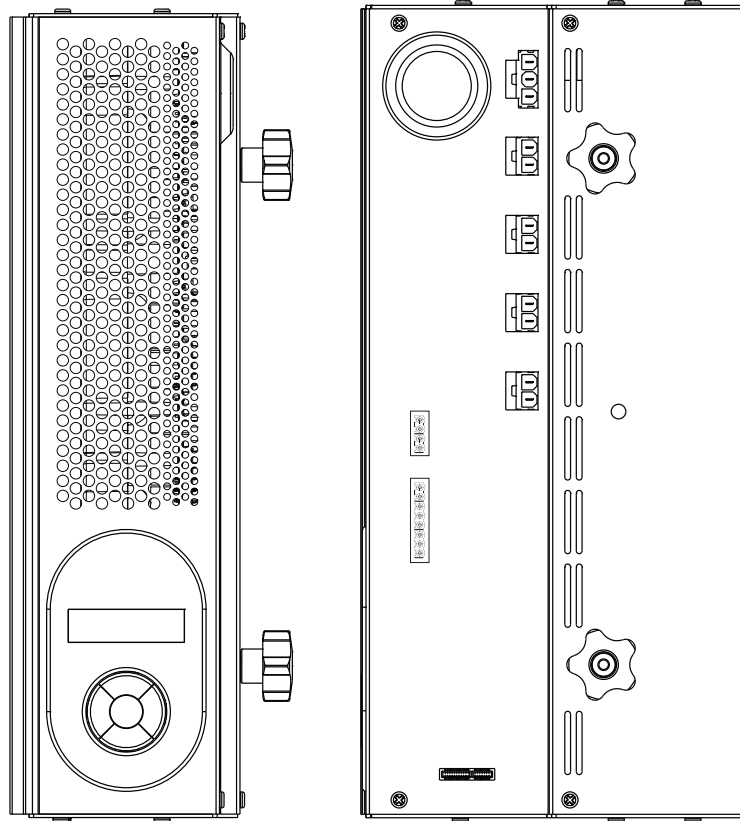

Introduction

The 458/DIM4 is an 4-Channel digital thyristor dimmer module, for leading-edge dimming of resistive and inductive loads. It has both a DALI and an S-DIM/DMX interface, and so can be fully integrated into a Digidim or Imagine router system. It can also be controlled by the Helvar TouchPanel, or used on standalone DALI or Digidim systems.

NOTE: DALI AND S-DIM / DMX MUST NOT BE CONNECTED SIMULTANEOUSLY.

Chassis modules

The 458/DIM4 module is attached to the 458M1, 458M2 or 458M3 chassis. The chassis modules are supplied with control module by-pass connectors, and can be fully installed and wired prior to fitting of the control module(s). This allows for all electrical installation, testing and powering up of the lighting circuits to be carried out prior to the fitting of the control modules. This prevents possible damage to the control modules due to circuit overload or faults, or the use of high voltage insulation testing equipment.

LCD display and keypad

The front of the module is equipped with an LCD display and keypad to set basic configuration parameters and provide basic control of channel and output levels.

Channels and load protection

The 458/DIM4 module has 4 channels rated at 10 A, with a total current capacity of 40 A.

Note: the correct chassis load protection must be chosen to ensure the required channel ratings are achieved, but not exceeded.

The dimmer module provides an auxiliary power supply, which can be used to power one TouchPanel, and has an optional Digidim power supply, which can be used to power DALI systems, if required.

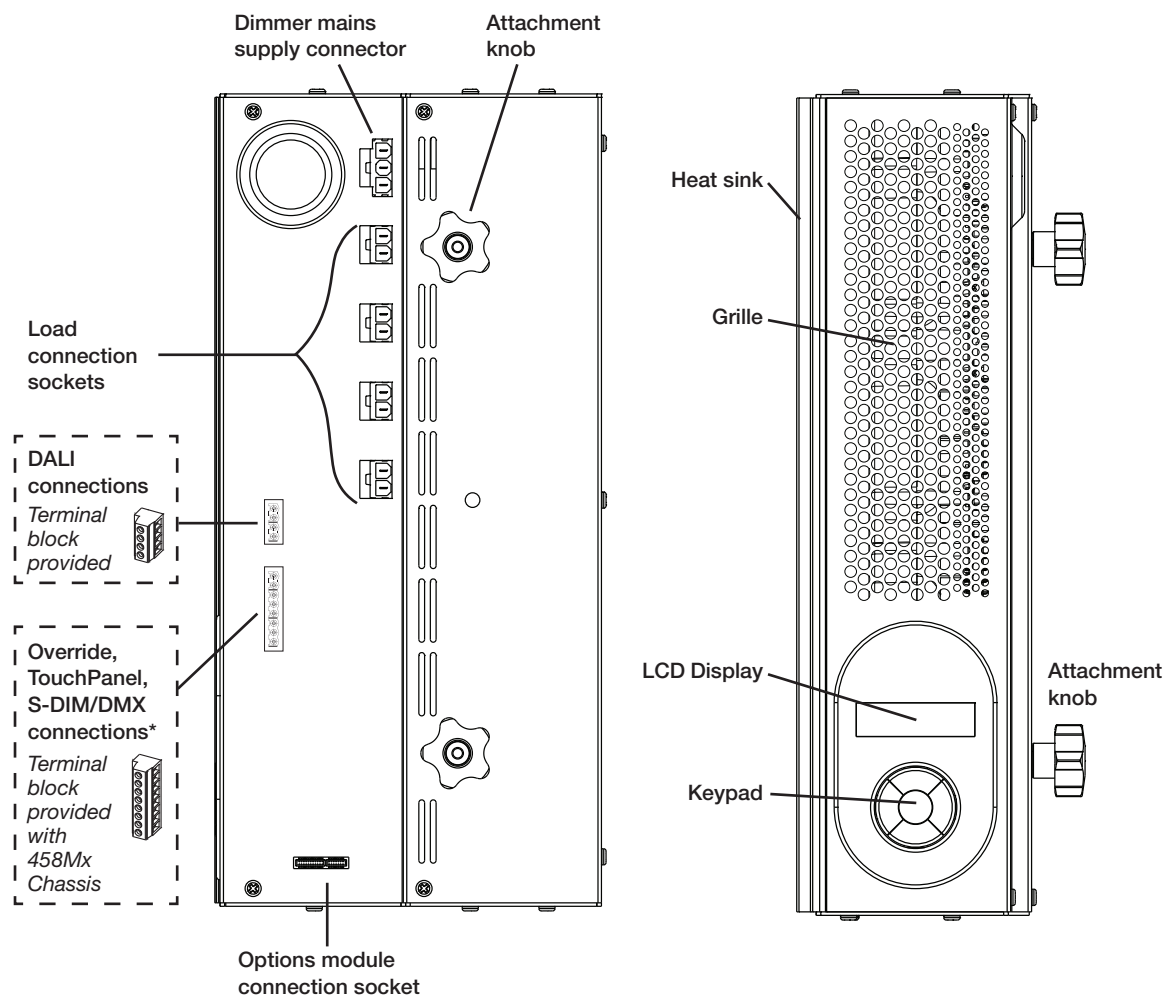

Installation

1. Attach the module to a chassis

Mounting, Environmental and Clearance Requirements

Mounting

- Attach the 458/DIM4 to a 458M1, 458M2, or 458M3 chassis, which is mounted vertically on a flat surface.

Environment

- The ambient temperature must be between 0°C and 40°C.
- Air humidity must be between 0% and 90% (non-condensing).
- The area must be adequately ventilated.
- Do NOT install this product in a damp location.

Clearance

- For effective ventilation, ensure that there is adequate space around the combined chassis and module(s): 50 mm above, below and on both sides. Refer to the mounting dimensions and clearance diagrams in the 458Mx Chassis Installation Guide.
- When a Helvar control module (e.g. dimmer unit) is attached, the grilles must NOT be obstructed.

Refer to the Helvar 458Mx Chassis Installation Guide for further information.

WARNING: BEFORE ATTACHING THE MODULE AND MAKING ANY CONNECTIONS, ENSURE THAT THE MAINS SUPPLY IS ISOLATED.

IMPORTANT: The dimmer may be controlled by either DALI or S-DIM/DMX, but DALI AND S-DIM / DMX MUST NOT BE CONNECTED SIMULTANEOUSLY.

1.1 Remove chassis cover

Refer to the 458Mx Chassis Installation Guide for details.

1.1 Remove chassis blanking plates

Unscrew and remove blanking plate(s) from the chassis.

Note 1: 458M1: 1 blanking plate;
458M2: 2 blanking plates;
458M3: 3 blanking plates.

Note 2: The diagrams on this page show the 458M1/4S10 Chassis.
Covers and knockouts are removed from the 458M2 and 458M3 in a similar way.

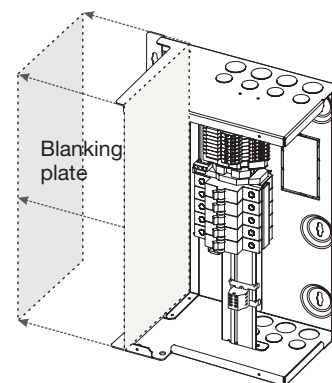

1.2 Loosen attachment knobs

Partially unscrew the two knobs on the dimmer module to reveal the pins.

1.3 Slot module pins into mounting bracket

Attach the module to the chassis by slotting the pins of the module to the mounting bracket.

1.4 Tighten knobs

Screw the knobs to the mounting bracket to secure the module.

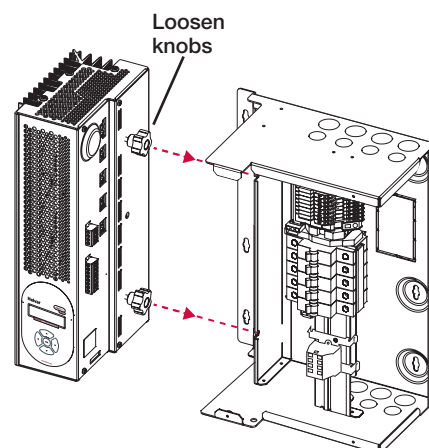

2. Connect power and load cables to module sockets

Connect the mains control supply as shown below.

The dimmer channel cables from the 458M chassis will be plugged into the chassis bypass terminals.

Unplug the cables from the bypass terminals, and connect them to the dimmer module channel terminals.

Note: The diagram on this page show the 458M1 chassis. Cable connection is similar for the 458M2 and 458M3.

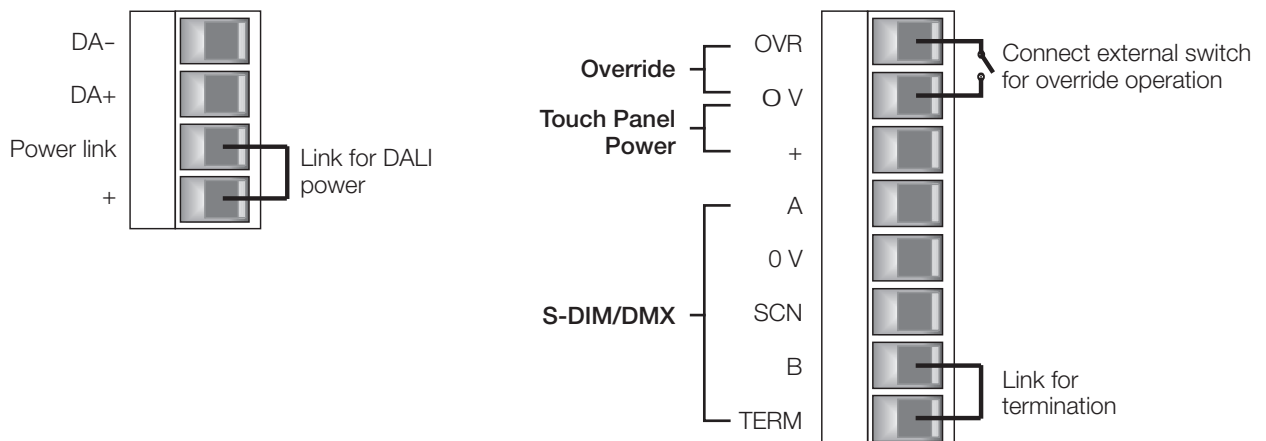
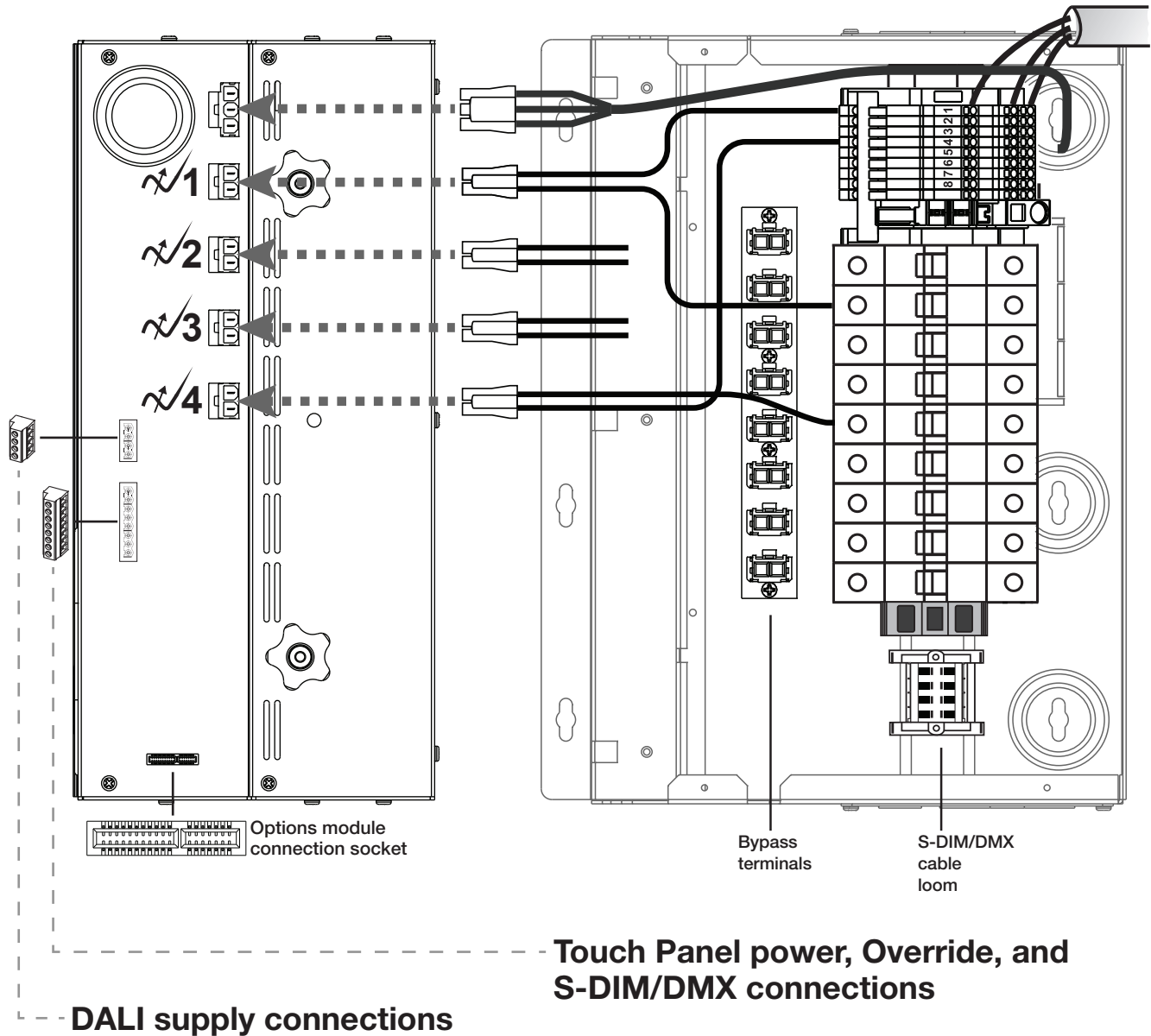

3. Make control connections

Refer to the connection diagrams on the previous page.

Ensure that all the necessary control connections have been made correctly and securely.

IMPORTANT:

ENSURE SEGREGATION BETWEEN MAINS CABLING AND OTHER CONNECTIONS.

DALI AND 1 – 10 V BALLAST CONNECTIONS SHOULD BE CONSIDERED AS POTENTIALLY LIVE.

3.1 DALI connections

If connecting to a Digidim system, use the DA+ and DA- terminals of the DALI connector.

If the built-in 250mA DALI power supply is required, wire between the '+' and 'Power Link' terminals of the DALI connector to provide DALI power.

IMPORTANT: REMEMBER THAT YOU CANNOT EXCEED THE DALI POWER SUPPLY LIMIT OF 250 mA

3.2 Override connections

If you wish to provide output level override functionality, wire a switch between the '0 V' and 'OVR' terminals of the S-DIM or DMX connector. Switch closure sets the light output of all dimmer channels to the override level.

3.3 Touch Panel power connections

Power can be supplied to one TouchPanel from the TouchPanel power connection terminal.

3.4 S-DIM and DMX connections

If connecting to a Helvar Imagine system, plug in the connector of the S-DIM/DMX cable loom to the S-DIM/DMX terminals. This is attached to the DIN-rail inside the chassis.

If the dimmer is at the end of the S-DIM/DMX cable, wire a link between the 'TERM' and 'B' connections of the S-DIM/DMX terminals to enable the cable termination.

4. Replace chassis cover

Replace the chassis cover, using the original screws.

5. Power on the unit

Power up the dimmer unit by switching on the MCBs. The LCD display should appear as shown.

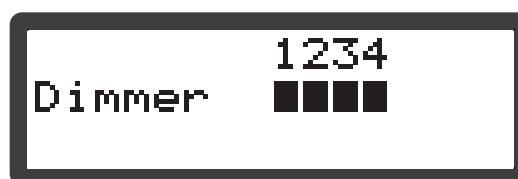

Start-up screen of module LCD display

Load Types

The 458/DIM4 is a thyristor dimmer and can control most load types, including:

- incandescent lamps;
- low-voltage halogen lamps with conventional and dimmable electronic transformers;
- mains halogen lamps;
- neon lamps with conventional and dimmable electronic transformers;
- dimmable LED lamps.

The table below shows the compatible load types and the minimum and maximum power per channel.

Note: This table should be used as a guide only. Always refer to the manufacturer's data for load capacities and dimming compliancy.

Load	Minimum per channel	Maximum per channel (see note 3)
Incandescent lamps / 230 V (mains) halogen lamps	25 W	2300 W
Low-voltage tungsten halogen wire-wound transformer (see notes 1 & 2)	50 VA	2300 VA
Dimmable cold cathode wire-wound transformer	50 VA	2300 VA
Leading-edge electronic transformers for low voltage halogen lamps	See notes 1 and 2	
Leading-edge electronic transformers for dimmable cold cathode	See notes 1 and 2	

Note 1: For other load types, refer to manufacturer's data.

Note 2: Transformers must be approved for dimming use by the transformer manufacturer.

Note 3: We recommend lamp loading of the transformer to no more than 80% of the nominal transformer power, unless otherwise specified by the transformer manufacturer. For example, a 500 VA transformer should not be loaded to more than 400 W of lamp load. In addition, the transformer has to be short-circuit proof on the secondary side, or it must be equipped with thermal protection on the primary side. The thermal protection is to be non-resettable or manually resettable only.

Control Panel

Control Panel Functions

The control panel is used to view and adjust:

- dimmer channel levels and (if connected) option module output levels
- various dimmer and options module settings

S-DIM connection

Example: to Helvar 920 Routers, or to Helvar TouchPanel.

Adjust these parameters using the control panel:

- Channel pairing (if 458/OPT4 options module connected)
- SCR Drive mode
- S-DIM addresses

Other parameters can be set using Designer software

DMX connection

Example: to Helvar 920 Routers, or to TouchPanel.

Adjust these parameters using the control panel:

- Channel pairing (if 458/OPT4 options module connected)
- Dimming curve
- DMX addresses
- Minimum fade time
- Output mode
- Override level
- SCR Drive mode
- Switch-on level

Other parameters can be set using Designer software

DALI connection

Example: to Helvar 920 Routers.

Adjust these parameters using the control panel:

- Channel pairing (if 458/OPT4 options module connected)
- Dimming curve
- Minimum fade time
- Override level
- SCR Drive mode

Other parameters can be set using Designer software

DALI standalone connection with Toolbox software

Adjust these parameters using the control panel:

- Channel pairing (if 458/OPT4 options module connected)
- Dimming curve
- Minimum fade time
- Output mode
- Override level
- SCR Drive mode

Other parameters can be set using Toolbox software

DALI standalone connection

This allows basic, 'out of box' scene recall, modify and store from a Helvar control panel. Other settings can be changed at the dimmer.

Note:

If S-DIM or DMX is connected and you change lighting levels or recall scenes on the Control Panel, then, after a short period of time, the levels revert to those being sent by the S-DIM/DMX master.

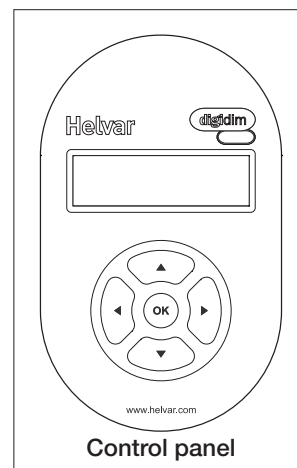

Control panel LCD display

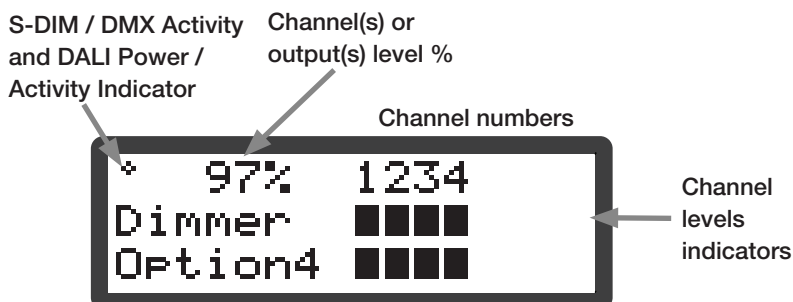

If the Options module is connected, output channel levels are displayed

S-DIM / DMX Activity and DALI Power / Activity Indicator: ✦

This indicator in the top left-hand corner of the 'Display Screen' indicates S-DIM/DMX activity or DALI power / activity: For S-DIM / DMX it is normally off, and flashes on intermittently for activity. If DALI power is on, then the indicator is on. It flashes to indicate DALI activity.

Channel / Output level %

The percentage shown is the level of the currently selected channel(s) or output(s). 'ALL' is displayed here if all channels or outputs are selected simultaneously, but are set to different levels.

LCD Display Main Screen

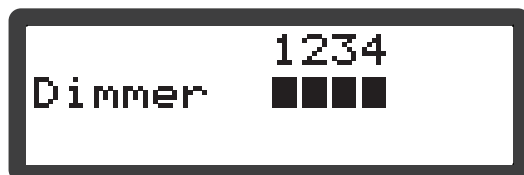

Main screen for 4-Channel dimmer

The Main Display Screen appears:

- When the 458/DIM4 is powered on
- After 60 seconds of inactivity on the Control Panel.
- After exiting the control panel options

Control panel keypad

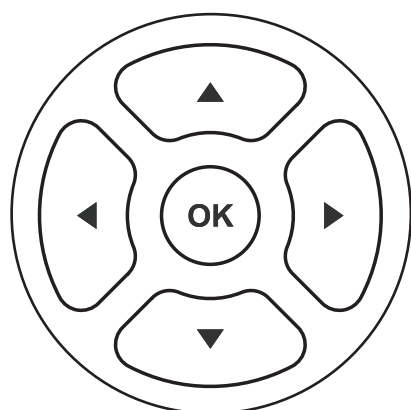



Use the keypad to:

- set dimmer channel levels
- set output channel levels (if an Options Module is connected)
- navigate the system menus to adjust module settings

Adjusting channel and output levels using the keypad

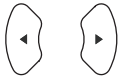
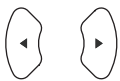
Follow these steps to adjust channel and output levels

<p>1. </p>	<p>(From the LCD Display Main Screen): Press either RIGHT or LEFT to access the dimmer and output (option) channel levels.</p>
<p>2. </p>	<p>Step left or right through channels / outputs The selected channel(s) or output(s) are shown by a flashing bar or 'o' (to indicate 0% light level).</p>
<p>3. </p>	<p>Adjust lighting level percentage (%) for the selected channel(s).</p>
<p>4. </p>	<p>Return to Main Display Screen</p>

Changing Lighting Levels for Dimmer Channels when 458/OPT4 connected

Channel pairing

If the 458/OPT4 Options Module is connected, by default, dimmer channels 1-4 are paired with outputs (options) 1-4.

When a channel is paired the dimmer channel will operated in switch mode.

Changing the levels of dimmer channels 1-4 affects the levels of outputs 1-4 accordingly.

If a channel is altered to non-paired (separate) operation, it is then possible to set its curve in the 'Dimming Curves' sub-menu.

Switch mode

When in switch mode, the dimmer channels will only turn on or off, and they will not dim.







Examples:

In switch mode (for DALI) with a dimmer channel level set to 1%, the channel turns on to 100%, and if set to 0%, it turns off;

In switch mode (for S-DIM/DMX) with a dimmer channel level set to 2% (default switch-on level for S-DIM/DMX), the channel turns on to 100%, and if set to 1%, it turns off. This setting can be changed in the 'Dimming Curves' sub-menu.

Navigating the menu using the keypad



Follow these steps to access and navigate the menus

1.		(From the LCD Display Main Screen): Press UP or DOWN to access the menu options.
2.		Scroll through main options.
3.		Select an option (access option screen).
4.		Adjust parameters.
5.		Step between different parameters in options screens
6.		Return to previous menu. Return to Main Display Screen (from main menu)

Physical selection

Physical selection mode allows loads and controls to be grouped together. It can be activated for a piece of equipment in a number of ways, including by using a Helvar remote control unit, or by using Designer or Toolbox software. Refer to the equipment instructions for details.

Follow these steps to use the module to identify a piece of equipment using physical selection mode.

1.	Put the piece of equipment (e.g. router, sensor etc) into 'physical selection mode' (refer to the manufacturer's instructions)	
2.		(From LCD display main page): Press either RIGHT or LEFT to access the dimmer and output (option) channel levels.
3.		Step left or right through channels to select the channel to be used for physical selection.
4.		Press UP or DOWN to physical select the channel
5.	Repeat steps 3 and 4 for each channel, as necessary.	
6.	Once identified, end 'Physical selection mode' for the piece(s) of equipment (refer to the manufacturer's instructions)	

Module Menu Options

Main Menu

Use the keypad to access and navigate and adjust the menu options: see 'Navigating the menu using the keypad.'
 Below is a table listing the main options available from the module control panel. Full options details are listed in the next section.

Addresses	Set S-DIM, DMX and DALI addresses, including base addresses, and S-DIM/DMX mode.
Ballast output	View and refresh ballast status; pair dimmer and ballast channels; set output mode. Note: The Options Module should be connected for these options.
Unit Details	View dimmer serial number, firmware version, and various other service-related information.
Recall scene	Recall DALI scenes.
Save as scene	Save levels as a DALI scene.
Default scenes	Reset DALI scenes to default settings.
Groups	Group and ungroup dimmer and ballast channels.
Dimming curves	Select dimming curves for dimmer channels.
Min fade time	Set minimum fade times for dimmer and ballast channels.
Power on level	Set DALI power-on levels for dimmer and ballast channels.
Failure level	Set (or disable) DALI failure levels for dimmer and ballast channels.
Override level	Set (or disable) override levels for dimmer and ballast channels.
Minimum level	Set DALI minimum load levels for dimmer and ballast channels.
Switch-on level	Set switch-on levels for S-DIM/DMX channels.
Max load level	Set maximum load levels for dimmer and ballast channels.
Hysteresis	Activate / De-activate S-DIM hysteresis for dimmer and ballast channels.
SCR drive mode	Select Hybrid, Triac or SCR (thyristor) drive mode.
LCD contrast	Adjust the LCD contrast level.
LCD timeout	Activate / De-activate the LCD display timeout function.
Factory reset	Reset all settings to factory defaults.
Use password	Apply password lock to settings (except to 'Unit details' and 'Enter password' items).
Enter password	Remove the password lock (see 'Use password')

Menu Options Details

Addresses

The digital interface (DALI or S-DIM/DMX) receives control messages from devices in the system.

You can set any address to any channel.

Note: The base address is the first channel address, from which the remaining addresses are allocated (unless changed manually in the address sub-menu).

Sub-menu items	Options
S-DIM/DMX mode	DMX or S-DIM (Default)
S-DIM/DMX base	S-DIM Base: 1 – 251 (Default: 1) DMX base: 1 - 509
S-DIM/DMX addr	Channel: 1 – 4 S-DIM Address: 1 – 254; Disabled (Default: 1) DMX Address: 1 - 512; Disabled (Default: 1)
DALI base	DALI Base: 1 – 61 (Default: 1)
DALI addresses	Channel: 1 – 4 Address: 1 – 64; Removed; Disabled Removed: Next time you connect it to a controller program or router, the DALI address will be re-allocated Disabled: The address will not be reallocated

Ballast output

Note: The Options Module must be connected for these options to be available.

Sub-menu items	Options
Status (Read-only)	---- = No ballast outputs present
Refresh	Rechecks status of ballast outputs
Channel pairs	Ballast Channel: 1 – 4 Dimmer Channel: 1 – 4; Separate You can configure these settings only if there is an Options Module connected. Whilst paired with a dimmer channel, the dimmer channel will operate in switch mode.
Output mode	Channel: 1 – 4; ALL (Default: 1) Mode: 0: 0/10V 1: 1-10V sink 2: 0-10V 3: PWM + 4: PWM – 5: DALI b'cast 6: DSI 7: (Off)

Unit Details

Sub-menu items	Options
Details (Read-only)	Serial number and Firmware version
Mode	Mode, power and data information If DALI power is on, a tick appears next to the DALI power field. DALI or S-DIM/DMX shows the last detected mode when the module was reset.
Temperatures (Read-only)	Heatsink and internal temperatures
Highest (Read-only)	Highest logged heatsink and internal temperatures
Mains (Read-only)	Mains voltage, frequency and reference voltage
User mode (All read-only);	Refer to the 'Troubleshooting' section of this guide for message details.

Recall Scene

Recall a scene previously stored (temporarily if connected to a Helvar router system). Scenes are sets of lighting levels and can make use of any combination of channels. This option is always available, even when password protection is applied to other options.
Range: Scene 1 -16

Save as Scene

The levels which are currently active for all channels of the dimmer are applied to this scene. You can recall stored scenes in the 'Recall Scene' menu (see above).
Range: Scene 1 -16

Default scenes

Default lighting scenes can be applied to the dimmer channels, i.e. scene 1 = 100%, scene 2 = 75%, scene 3 = 50%, and scene 4 = 25%.
Note: Lighting levels are NOT changed automatically once you apply default scenes; but once you recall a scene, lighting is set to the levels for that scene.

GROUPS

Assign channels to DALI groups. Any channel can be assigned to any group.

Options:

Group: 1 – 16

Dimmer options: ✓ (Up button);
x (Down button).
(Default: xxxx)

Dimming curves

Configure the shape of the dimming curve to suit the requirements of your lighting equipment.

Options:

Channel:	1 – 4; ALL	
Curves:	0: Non-dim	(Switch mode)
	1: Linear	(S-DIM mode) (S-DIM default)
	2: Square	(S-DIM mode curve)
	3: S-Law	(S-DIM mode curve)
	4: Log	(DALI mode curve) (DALI default)
	5: SSL	(DALI mode curve) [SSL = Solid State Lighting]
	6: Linear	(DALI mode curve)

Min fade time

Set the minimum time it takes to change between minimum and maximum lighting levels.

Options:

Channel:	1 – 4, ALL
Fade time:	0: 20 ms
	1: 150 ms
	2: 500 ms
	3: 1 sec (Default)

Power on level

Set the level each channel will go to when the unit is powered on, with DALI connected.

Note: Power-on levels for S-DIM are set in the router, and not using the control panel.

Options:

Channel:	1 – 4; ALL
Power on level:	0 – 100%; Last (Default in DALI mode:100%)

Failure level

Set channel levels for situations where the DALI bus goes low, such as when it is short-circuited or the DALI PSU is turned off.

Options:

Channel:	1 – 4; ALL
Failure level:	0 – 100%; **** (= do not apply Failure level); (Default:100%)

Override level

If the override input connection is short-circuited, e.g. by contact closure on an alarm system, all channels are set to their override level, regardless of external control signals.

Options:

Channel: 1 – 4;
ALL
Override level: 0 – 100%;
**** (= do not apply override level);
(Default:100%)

Minimum level

Set the minimum DALI lighting level the channel will achieve when turned on, no matter what scene is called or level is set.

For example, if you set a minimum level of 50% and call scene 4 (at 25% level), the channel output level will be 50%.

For S-DIM/DMX, the level set here is actually the switch-on level, and the channel will not turn on unless it receives a command to go to or above this level. See **Switch-on level** (below).

The minimum level is 1% by default. If you set the minimum level to 100%, this forces the dimming curve into switch mode.

Options:

Channel: 1 – 4;
ALL
Minimum level: 0.1%;
1% – 100%;
(Default: 0.1%)

Switch-on level

Set the switch-on levels for S-DIM/DMX channels.

Options:

Channel: 1 – 4;
ALL (Default)
Switch-on level: 0% – 64%;
(Default: 2%)

Max load level

Limit the maximum output level of each channel. You can set the maximum level to between 1% and 100%.

Note: The maximum level is 100% by default.

Options:

Channel: 1 – 4;
ALL
Maximum level: 1% – 100%;
(Default:100%)

Hysteresis

Note: Hysteresis is supported only when controlled by S-DIM.

This setting affects the level at which the channel turns off. When hysteresis is on, the switch-off level is 80% of the switch-on level. At or below the switch-off level, the channel will be off. For example, if the switch on level is 50%, and the signal rises to this level or above, the channel turns on, then if the signal falls to 40% or below, the channel turns off.

By default on the dimmer:

- When hysteresis is on and the signal rises to 2%, the lighting for that channel turns on; when it falls to 0%, the channel turns off.
- When hysteresis is off (default setting) and the signal rises to 2%, the lighting for that channel turns on; when it falls to 1%, the channel turns off.

Options:

Channel: 1 – 4;
ALL

Off: ✓ (up button);
x (down button)
(Default: x)

SCR Drive Mode

Set the output mode to allow for various load types. This sets the mode for all outputs of the dimmer: they cannot be set independently.

Options:

SCR drive mode:
0 Hybrid (Default);
1 Triac;
2 SCR (thyristor) [SCR: silicon-controlled rectifier]

LCD Contrast

Set the LCD display contrast: 0–100% (default: 40%)

Note 1: Even at 0%, the text is just visible.

Note 2: The display adjusts as you raise or lower the contrast value, but you must press 'OK' to select that contrast level.

LCD timeout

When the LCD timeout is on, after 60 seconds of inactivity on the Control Panel, the back-light on the LCD 'Display Screen' dims down and the Control Panel is then in standby mode.

Options:

Timeout: ✓ (up button);
x (down button)
(Default: ✓ = yes)

Factory reset

Reset the dimmer to the original settings (defaults).

Note: Restoring factory settings returns all connected lighting to default levels immediately.

Press and hold 'OK' for 10 seconds until , a '✓ **Done**' message appears.

Use Password

Note: The password is disabled by default.

You can use the factory-set password for the dimmer unit.

If the password is enabled, you must enter the correct password, otherwise you can only use the following functions / menus:

- Change dimmer levels
- View technical information about the dimmer
- Recall a scene
- Enter the password

If you chose to use the password, after 1 minute of inactivity, the Control Panel goes to standby and the 'Enter password' menu appears in 'Main Menu'.

'Use Password' disables the functionality of the remaining menus. You can access the menus but cannot change any settings, unless you enter the password (58).

A key (🔒) is displayed in the bottom right of the screen when you enter the menu, to indicate that you cannot enter any settings.

Options:

Use password: (password is 58)

✓ (up button);

x (down button)

(Default: x = no)

Press 'OK' to confirm new selection, and a "✓ **Done**" message appears.

The password lock will be applied after a period of 60 seconds from this message appearing.

Enter Password

If the password is enabled and you wish to use all of the functions of the dimmer, you must enter the correct password.

Troubleshooting

Error messages

If an error occurs, a flashing message appears at the top of the LCD display screen.

The table below lists these error messages and their meanings:

Message	Reason	Output	Trip	Notes
Too Hot!!	Output limiting due to heatsink or internal temperature	Reduces	-	Preceeds temperature trip, > 80°C
Mains Freq	Mains frequency outside limits	Off	-	Frequency is < 45Hz or > 65Hz
No Mains ZC	No zero crossings observed (informative after Mains Freq trip)	Off	-	Mains zero crossings not detected for 2.5 seconds
Mains High	Mains voltage too high	Off	-	> 276 volts RMS
Mains Low	Mains voltage too low	Off	-	< 70 volts RMS
Temperature	Dimmer has reached or exceeded the trip temperature	Off	Resettable	Reset from front panel. > 90°C.
EngineFault	Mains acquisition failure	Off	Latched	Unit must be power cycled
Thermometer	Temperature sensor failed	Off	Latched	Read < -30°C. Unit must be power cycled
Override On	Override input pulled low	Override level	-	User can change override levels on-the-fly (unless locked)
Comms Error	S-DIM communications error e.g. two units with the same S-DIM address, or incorrect S-DIM/DMX mode selection.	-	-	-

458/DIM4 Technical Specifications

Connections

DALI:	0.5 mm ² - 1.5 mm ² (max. 300 m @ 1.5 mm ²)
S-DIM / DMX	0.22 mm ² - 1.5 mm ² low-loss RS485 Type (multi-stranded, twisted and shielded)
Override	0.5 mm ² to 1.5 mm ² (screened and twisted)

Power

Mains supply voltage:	85 VAC to 264 VAC, 45 - 65 Hz
Power consumption:	1.3 W (with no DALI or TouchPanel PSUs used)

Supply

Supply current:	40 A (max)
Nominal load:	4x 10 A loads
DALI supply:	250 mA (max), 16 VDC (nominal)
TouchPanel supply:	250 mA (max), 16 VDC (nominal)
Output regulation:	Automatic compensation for supply voltage and frequency variations

Protection

Electrical protection:	6 A MCB and PTC for control board (MCB type C 10 kA) For load protection: refer to 458Mx installation guide.
Thermal protection:	Control board – resettable fuse, power devices – thermal sensing

Conformity and Standards

EMC Emission:	EN 55015
Immunity:	EN 61547
Safety:	EN 60950
Isolation:	4 kV
IP rating:	IP 20
DALI data transfer:	According to DALI standard IEC60929, with Helvar extensions
S-DIM data transfer:	Helvar protocol (RS485, 115 kpbs)
DMX data transfer:	DMX512-A protocol
Environmental:	Complies with WEEE and RoHS directives

Installation

Mounting:	Attached to 458M1, 458M2, or 458M3 chassis
-----------	--

Mechanical Data

Dimensions (L x W x H):	See diagram
Weight:	6.2 kg
Housing:	Powder coated steel (black)
Heatsink:	Anodised aluminium

Operating and Storage Conditions

Ambient Temperature:	0°C to 40°C
Storage Temperature:	-10°C to 70°C
Relative Humidity:	Max 90%, non-condensing

Dimensions

Dimensions in mm

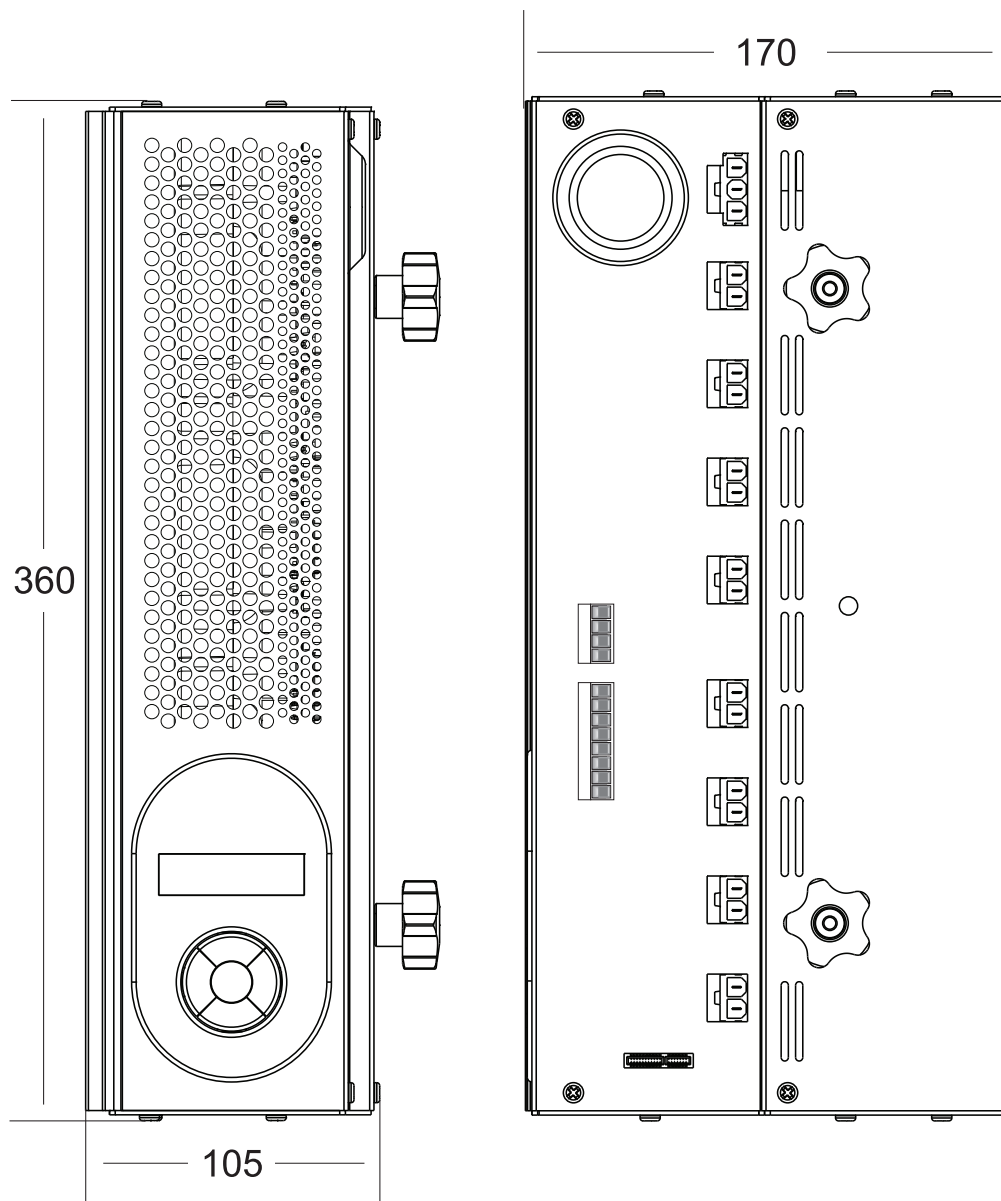

- Ⓔ For further information see www.helvar.com
- Ⓓ Für weitere Informationen siehe www.helvar.com
- Ⓕ Lisätietoja: www.helvar.com
- Ⓔ För mer information besök www.helvar.com
- Ⓕ Pour plus d'informations, visitez www.helvar.com
- Ⓕ Per ulteriori informazioni consultare www.helvar.com
- Ⓔ Дополнительную информацию см на www.helvar.com

www.helvar.com