

DBC1210

12 x 10A HF Ballast Controller Installation Manual

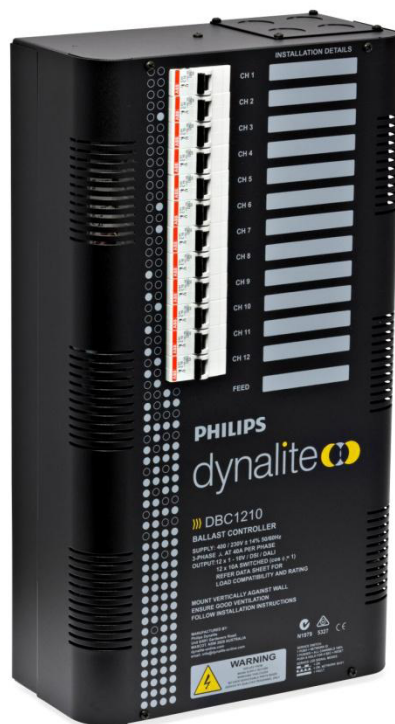

contents

Warning.....	2	Hardware Controls.....	7
Features.....	2	Troubleshooting.....	8
Important Safeguards.....	2	Specification.....	8
Internal View.....	3		
Mounting.....	4		
Supply & Load Cable Connections.....	5		
Connecting Serial Control Cables.....	6		

Supplied by:



Melbourne
03 9701 2500

Sydney
02 9737 8988

info@lightmoves.com.au

www.lightmoves.com.au



Warning

- TO REDUCE THE RISK OF FIRE OR ELECTRIC SHOCK, DO NOT EXPOSE THIS DEVICE TO RAIN OR MOISTURE.
- DO NOT ENERGISE UNLESS THE FRONT COVER IS IN PLACE.
- THIS DEVICE MUST BE EARTHED.
- INSTALLATION, PROGRAMMING AND MAINTENANCE MUST BE CARRIED OUT BY QUALIFIED PERSONNEL

features

- **Three Phase Supply**
3 phase and neutral at 40A per phase.
- **12 Switched Outputs**
Each 10A output is switched via a high specification relay with specially treated contacts which prevent contact fusion when switching very reactive loads.
- **12 Control Outputs**
Each of the 12 optically isolated outputs can be configured to be either 1-10V, DSI or DALI serial control, covering the latest types of HF Fluorescent Ballasts. Also compatible with 1-10V, DSI and DALI dimmable electronic transformers.
- **MCB Protection**
Each mains output is protected by a single pole magnetic circuit breaker.
- **Many Control Options**
Control of this device can be from a combination of methods, eg. serial control port, relay contacts, push button wall stations, infra red receivers and timeclocks. Easy high-level interface to other popular AV control systems and Building Management Systems (BMS) is also available.
- **Simple Installation**
Wall-mount enclosure with mounting lugs facilitates installation. Cable knockouts are provided at the top and right hand side of the enclosure for supply and load cables, with low voltage (LV) control at the bottom.

important safeguards

Warning – This is a class A product. In a domestic environment this product may cause radio interference in which case the user may be required to take adequate measures.

Read Instructions – We recommend that you read this instruction manual prior to commencement of installation. Retain instructions and give the end user

Troubleshooting - If problems are encountered, check the troubleshooting section on page 8.

Special Programming – Once powered and terminated correctly this device will only operate in basic mode. A new Dynalite panel will turn on all lighting channels from button 1 and turn off from button 4 if network terminations are correct. Only once the full network is test correct can commissioning begin. Advanced functions can be commissioned via Envision software. If commissioning is required, contact your local distributor for details.

Check Connections – Treat this device as a switchboard that has been shipped. Tighten all load-carrying screw connections, as vibrations from transport can cause MCB and terminal block screws to become loose.

Power Sources – This device should only be operated from the type of supply specified on the front panel. This device *must* be earthed.

Output Circuits – The load on a circuit should not exceed the specified capacity of 10A. Loads should be calculated to ensure that the overall maximum capacity of 120A is not exceeded.

Load Control Circuits – If this device is being used to control 1-10V, DSI or DALI HF fluorescent ballasts, a 2 core mains rated control cable is required to be run to the loads, in addition to the mains feed.

Load Type – Default settings are for load control outputs to be DSI. Check to see what type of HF Fluorescent Ballasts are in the luminaries. Do not terminate the control lines to any DALI or DSI loads until the relevant channel has been programmed appropriately. When connecting 1-10V load control lines, pay attention that the correct polarity is maintained.

Megger Testing – Do not megger test any circuitry connected to the dimming system, as damage to the electronics may result.

Mounting Location – This device must be mounted right way up, on a vertical surface (refer to page 4 for mounting instructions). The specified minimum clearance of 100mm for all sides must be adhered to. Install in a dry, well-ventilated location. Controllers may emit some mechanical noise. Take this into account when deciding the mounting location.

Data Cable – The recommended cable for connections to the serial port is screened, stranded RS485 data cable with three twisted pairs. Part numbers for various manufacturers are listed on page 6. This cable should be segregated from mains cables by a minimum distance of 300mm. If anticipated cable runs are over 600 metres for serial cables, consult your dealer for advice. Do not cut or terminate live data cables.

internal view

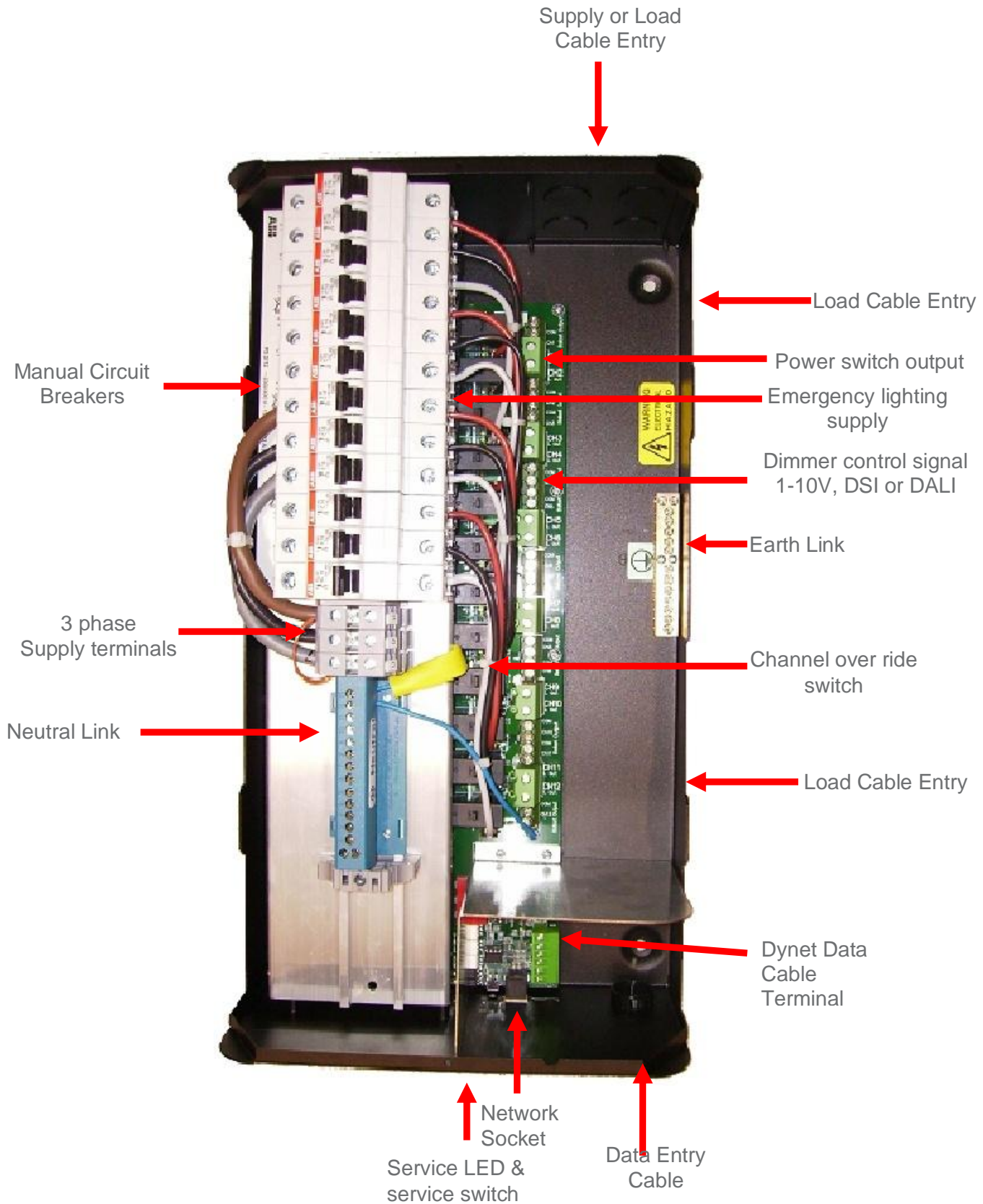

For spare parts, please call your nearest Dynalite Customer Service Centre, and specify **DBC1210**

mounting

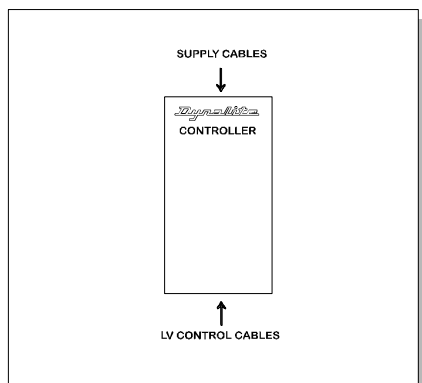
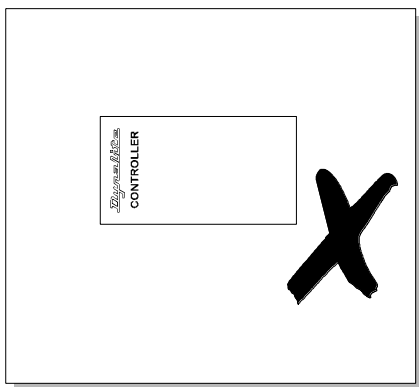
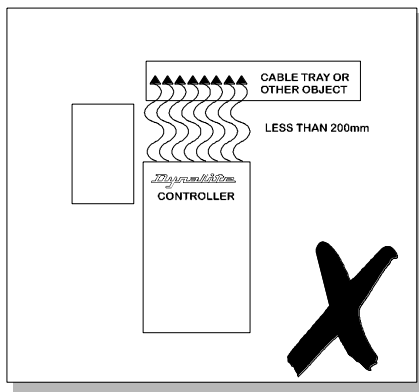
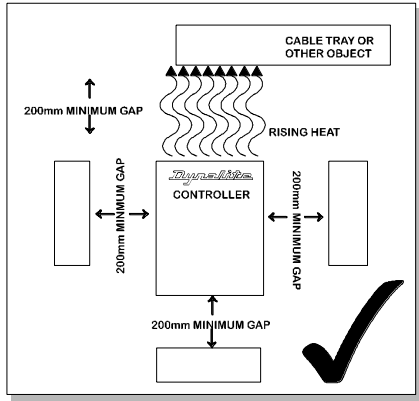

Select A Suitable Location

This device is designed for indoor use only. If installing in an external location, the DBC1210 must be housed in a suitable well-ventilated enclosure. Choose a dry location, that will be accessible after the installation is complete. The DBC1210 should be mounted *vertically, the right way up*. An air gap of 100mm on each side and at the top and bottom of the device should be adhered to. This air gap is required to ensure the serviceability of the DBC1210 without its complete removal from the mounting surface. This device may emit some mechanical noise. Take this into account when deciding the mounting location.

Fixing the Device

The DBC1210 has integral mounting brackets attached to the inside of the enclosure. The brackets are designed to accommodate 4 fixing screws up to 8mm diameter. The DBC1210 can be fixed to the wall without opening the cabinet or removing covers. Make sure no dust or other debris enters the device during installation. Do not leave the front cover off for any length of time. Excessive dust and dirt can degrade the cooling of the internal components.

Allow for Cable Entry

Supply and load cables enter the enclosure at the top. If these cables are fed from below the mounting position, they should be routed around the enclosure to enter at the top, or alternative knockouts are provided on the right side below the lid line. An alternative method is to stand the enclosure off from the mounting surface by mounting it on a cable tray or a Unistrut style product. The cables can then be routed between the enclosure and the mounting surface, and enter the enclosure via the cutout provided on the mounting face. The control cables enter at the bottom of the enclosure. Control cables should never be run in the mains voltage sections of the enclosure

supply & load cable connections

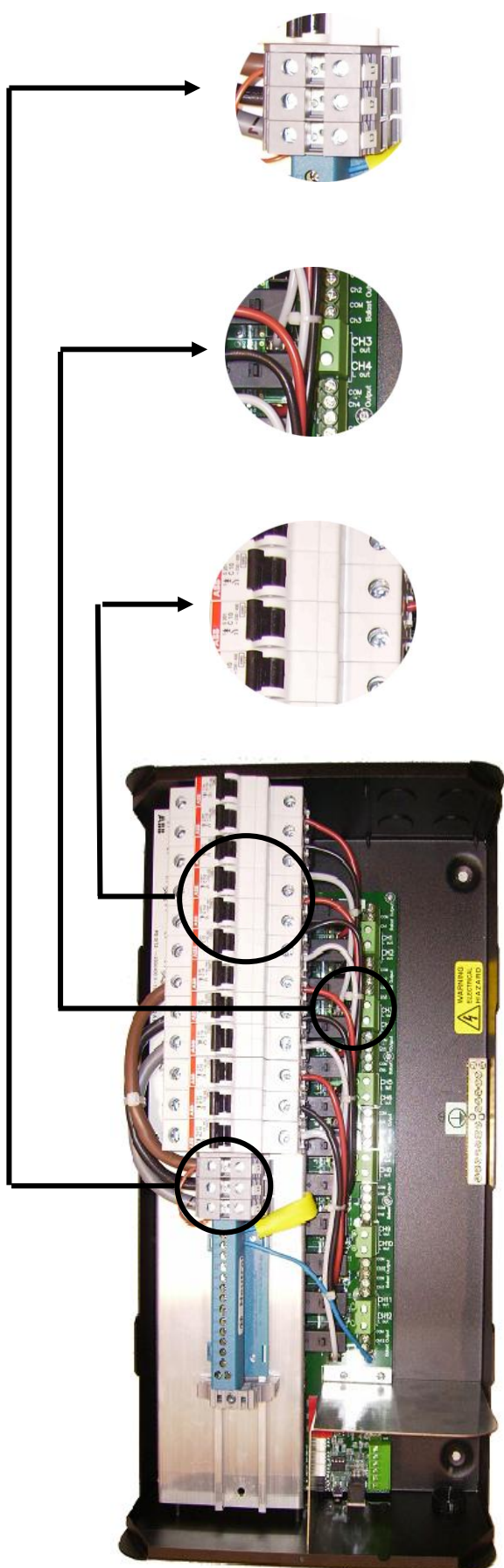

Supply Cables

The supply input terminals are located toward the centre of the enclosure and consist of Earth, Neutral and 3 Phases, which will accept up to 16mm² cables. The supply cables should have a capacity of 40A per phase, to allow the device to be loaded to its maximum capacity.

Load Cables

Load cables can be terminated on the 2-way Load terminal blocks (two for each channel), a Neutral link and an Earth link located at the centre of the enclosure. These connectors will accept up to 10mm² cables. *It is important that an individual output circuit is not overloaded.* Calculate the intended load, and ensure that it is below the maximum capacity of an individual channel, which is 10A. To ensure compliance with interference standards, the load neutral cables must be individually connected to the neutral link terminals inside the cabinet. *Never use a common neutral at a remote location.*

Load Control Cables

Load Control cables can be terminated on the 4 way and 2 way terminal blocks located directly next to the Load terminals. These terminals are the outputs for 0 to +10V, DSI or DALI if selected by software setup. Note that most types of 1-10V HF fluorescent ballast control wiring is polarity conscious. DSI ballasts are not polarity conscious.

Emergency Lighting Connections

Connect Emergency Lighting circuit active to the load side on the circuit breaker for the relevant channel, as indicated by the labels next to the circuit breakers. Do not remove any cables that may already be terminated at this location.

Energising the Device

If it is necessary to energise load circuits before any control cables are connected, it is acceptable to replace the cover and energise the device immediately, as the default factory programming is to have all channels set to 100% output. If there is no output on any or all channels, see the troubleshooting section (page 8). This device should be de-energised before terminating the control and data cables.

connecting serial control cables

Connect Data Cable in a 'Daisy Chain'

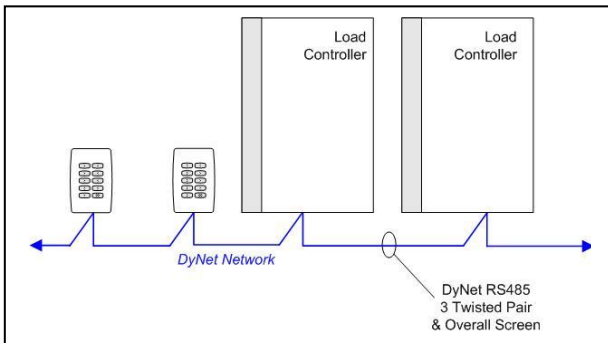

Determine Your Requirements

Serial ports are used to interconnect other dimmers, smart control panels, sensors and AV controllers. Serial port devices can be identified by 4 terminals, labelled: GND, DATA+, DATA-, +VE.

Serial Cable Connections

There is one RS485 port for DyNet signals, in the form of a RJ12 socket, on the front panel, which is used for the temporary connection of a PC or a DPP601 Portable Programmer. There are data terminals on the control card, for permanent connections. The recommended cable for connections to the serial port is screened, stranded RS485 data cable with three twisted pairs. Recommended cable types include:

Belden:	9503
Dynalite:	DYNET-STP-CABLE
Garland:	MCP3S
Hartland:	HCK603
M&M Cable:	B2003CS
M&M Cable:	B9503CS
Multicables:	AWM E120236 2092 20
RS Components:	368-687
Dynalite	DYNET-STP-CABLE

One pair is paralleled for GND, one pair paralleled for +VE and one pair used for DATA+ and DATA -.

RJ12 Socket Connections

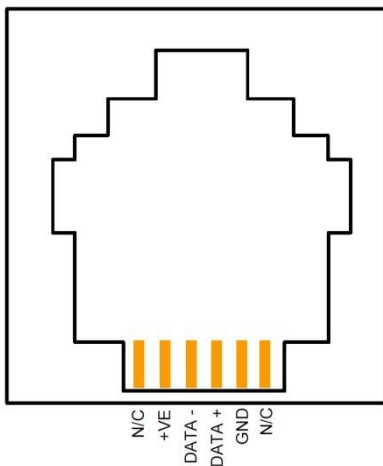

Recommended Cable Colour Coding

- Green/White pair:* Paralleled for GND
- Orange/White pair:* Paralleled for +VE
- Blue/White pair:* Blue for DATA+
- White for DATA-
- Brown/White pair:* Spare or for Join

Serial Cable Permanent Connections

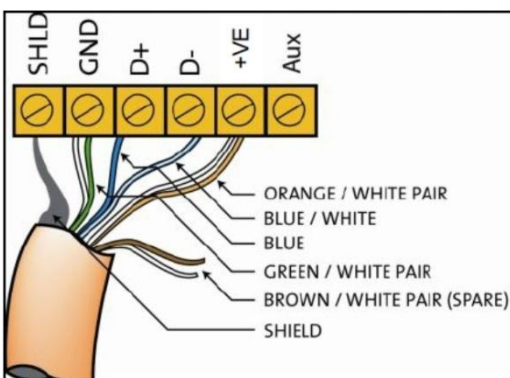

The colour-coding scheme used is not critical, as long as the same scheme is used throughout the installation.

Serial Cable Connecting Method

The recommended connecting method is to 'daisy chain' devices (starting at the first device, then looping in then out of devices, with a single cable terminating at the last device. There should not be any spurs or stubs, and only the first and last device should terminate one cable. All other devices should terminate two cables). Devices may be wired in any order. The data cable should be segregated from any mains cables. *A data cable that is connected to an energised dimmer is live. Do not cut or terminate live data cables.* If the data cable has to cross over any mains cables, it is recommended that it do so at a 90° angle.

Diagnostic Information

AUX Input - This is a dry contact interface that is active low. The dry contact is connected between the AUX and GND terminals on the DyNet connector strip. The function of the AUX input is programmable. Ensure that the cable length between the dry contact and terminal strip is no longer than 2 metres.

Service LED - The Service LED has 3 signalling modes, which are useful for troubleshooting:

Blinking slowly (1Hz) = Normal Operation

Blinking fast (4Hz) = Network Activity Detected

On = Fault

Service Switch - The Service Switch has three functions:

1 push = Transmit Network ID

3 pushes = All Channels 100%

Push & hold for 4 sec = Reboot

Top Set – This control is not used in ballast controllers.

Accessory Module Socket - Accepts a plug in module for an optional feature such as a DMX512 ports. Consult your distributor for details on the available accessory modules.

troubleshooting

Check the following list. If you are still unable to rectify the situation, contact your nearest Dynalite office. A complete list of distributors worldwide can be found on the Internet at:

www.philips.com/dynalite

Please ensure that you have completed the following prior to calling our technical support department.

- Check all symptoms in the Troubleshooting list
- Check for any deviations between the installation and the installation instructions
- Make a list of the model numbers of all devices used in the system

SYMPTOM	PROBABLE CAUSE	ACTION
Dimmer does not operate at all. No Service LED activity. Power supply indicator LED on PCB not lit.	Incorrect connection of mains supply or no power available.	Check power supply to dimmer. Check Line and Neutral input connections.
Power supply indicator LED lit, but no Service LED activity.	Supply voltage too low, short circuit on network. Control PCB faulty.	Check supply voltage is at least 75% of rated voltage. Check 5V & 12V terminal voltages, 5V supply must be present. Disconnect network bus and restore power. Replace control PCB.
Dimmer will not respond to control panel push buttons.	Control panel incorrectly wired. Incorrect configuration.	Check operation of LEDs on control panel. Push button on panel and study response of service LED.
Dimmer operates properly but circuit breakers keep tripping.	Instant tripping: - short circuit on load. Delayed tripping: - Dimmer overloaded.	Check load wiring for short circuits. Verify dimmer loading with current tester (don't forget to de-rate for low power-factor loads and transformer losses). Check that the breaker terminals are tight.
Fluorescent lights won't dim.	Wrong type of ballast or ballast incorrectly wired. Control cable from dimmer to ballasts not installed.	Check ballast type. Check actual wiring against ballast manufacturer's diagram. Check 1-10V/DSI/DALI cable and settings.

specification

Supply:	230V ±14% 50/60Hz 3-Phase Y at 40A per phase
Line Outputs:	12 x Switched outputs at 10A per channel (total device load 120A)
Control Outputs:	12 x load control outputs, selectable to 1-10V, DSI or DALI Broadcast
Protection:	12 x 10A 6kA single pole thermal magnetic circuit breakers
Switching Device:	Relay – 50A 230V AC inductive (5000W lighting load rated)
Control Inputs:	1 x RS485 DyNet serial port 1 x programmable dry contact AUX input
User Controls:	Service switch Diagnostic LED
Internal Controls:	Programmable Logic Controller
DyNet DC Supply +VE:	120mA Supply for approx 6 panels)
Preset Scenes:	170
Supply Terminals:	Line1, Line2, Line3 1 x 16mm ² max conductor size
Output Terminals:	Line for each channel 1 x 6mm ² max conductor size Neutral link bar provided Earth link bar provided 0V/DSI/DALI, +V/DSI/DALI for each channel 1 x 2.5mm ² max conductor size
Cable Entries:	Mains – 4 x 25mm dia. knockouts mounted on a 85mm x 85mm removable gland plate Loads – 6 x 25mm dia. knockouts located on the right hand side of the unit Data – 1 x 25mm dia. knockout
Diagnostic Functions:	Device online/offline status Circuit breaker trip monitoring (optional) Circuit run time tracking (optional)
Compliance:	CE, C-Tick
Operating Environment:	Ambient Temperature 40°C max, RH 90% max non condensing
Construction:	Alloy/Steel wall mount case with epoxy finish
Dimensions:	H 457mm x W 252mm x D 126mm
Dimensions –RCBO Version:	H 585mm x W 252mm x D 126mm
Weight:	10.25 Kilograms