



iW Cove MX Powercore

Premium interior linear LED cove and accent fixture with intelligent white light

iW Cove MX Powercore

Premium interior linear LED cove and accent fixture with intelligent white light

iW Cove MX Powercore is a high-performance, white-light LED fixture that brilliantly illuminates alcoves and other interior spaces wherever adjustable color temperature is required. With three channels of warm, neutral, and cool LED sources, this compact, versatile fixture offers a color temperature range of 2700 K to 6500 K. With its rotating housing, flexible end-to-end locking power connectors, and wide and medium beam angles, iW Cove MX Powercore is the perfect choice for retail, exhibit, hospitality, and architectural applications.

- Superior beam quality — Available in 1 ft (305 mm) and 4 ft (1.2 m) die-cast aluminum housings with wide (110° x 110°) and medium (50° x 70°) beam angles. Delivers striation-free light within close distance from fixture placement with no visible light scalloping between fixtures.
- High-performance illumination in a wide range of color temperatures — Channels of warm, neutral, and cool white LEDs produce color temperatures ranging from 2700 K to 6500 K. Offers the greatest possible light intensity at all color temperatures. Fixture brightness can be varied while maintaining constant color temperature.
- Integrates Powercore technology — Powercore technology rapidly, efficiently, and accurately controls power output to fixtures directly from line voltage. The Philips Data Enabler Pro merges line voltage with control and delivers them to the fixture over a single standard cable, dramatically simplifying installation and lowering total system cost.
- Universal power input range — Power input of 100 to 240 VAC for consistent installation anywhere in the world.
- Easy installation — By delivering line voltage directly to the fixtures, Powercore simplifies installation by reducing the number of external power supplies, allowing long product runs and eliminating the need for special wiring. Easy-to-install 4 ft (1.2 m) mounting tracks allow quick project setup in linear applications.
- Flexible mounting and positioning — With end-to-end locking power connectors that can make 180° turns, these compact cove fixtures are easy to position in even the most challenging mounting circumstances. 1 ft (305 mm) and 5 ft (1.5 m) jumper cables can add extra space between fixtures. Optional mounting tracks support vertical and overhead positioning.



Superior Binning Algorithm Sets New Standard for Color Consistency

iW Cove MX Powercore exceeds the recognized standards for color quality to guarantee uniformity and consistency of hue and color temperature across LEDs, fixtures, and manufacturing runs.

Variable Atmosphere at the Touch of a Button

Rustic Kitchen

Boston-based Rustic Kitchen Bistro & Lounge creates an inviting glow, largely due to its famous wood burning oven and rich lighting.

The restaurant owners wanted attractive lighting to properly accentuate the alcoves within the Biltmore-inspired ceiling in the restaurant's Tuscan Room. Neon and fluorescent light sources did not offer the desired color temperatures, and the owners did not want to have to deal with frequent lamp replacements in the dining room. Because they offer a wide range of color temperatures, long useful source life, and virtually maintenance-free operation, the restaurant owners chose iW Cove Powercore tunable white light fixtures for the installation.

These high-performance linear fixtures provide controllable white light ranging from a warm 2700 K to a cool 6500 K. Unlike conventional light sources, the fixtures maintain their precise color temperature even as they are dimmed.

With iW Cove Powercore, the staff can set the precise shade of white light that they desire at the touch of a button — a cooler color temperature during the day, for example, and a warmer color temperature in the evening.



Photography: John Brandon Miller

Photometrics

Photometric data is based on test results from an independent NIST traceable testing lab. IES data is available at www.philipscolorkinetics.com/support/ies.

iW Cove MX Powercore 1 ft (305 mm), 110° x 110° beam angle 2700 K channel only

Lumens	184
Efficacy	20.9 lm / W

Polar Candela Distribution

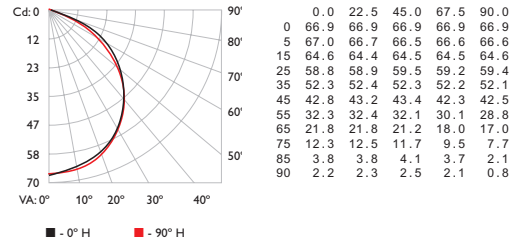

Illuminance at Distance

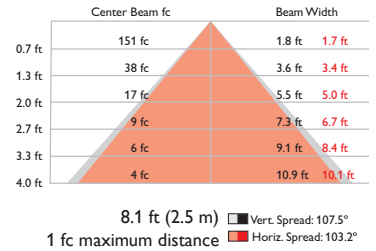

Zonal Lumen

ZONE	LUMENS	%FIXT
0- 30	51.8	28.1
0- 40	84.4	45.9
0- 60	145.4	79.0
0- 90	181.2	98.5
90-120	2.5	1.4
90-130	2.7	1.5
90-150	2.8	1.5
90-180	2.8	1.5
0-180	184.0	100.0

Coefficients Of Utilization - Zonal Cavity Method

RC	Effective Floor Cavity Reflectance: 20%														
	80			70			50			30			10	0	
RW	70	50	30	10	70	50	30	10	50	30	10	50	30	10	0
0	119119119119	116116116116	1101101101	105105105	101101101	98									
1	108104 99 96	106101 97 94	97 94 91	93 90 88	89 87 85	83									
2	99 91 84 78	96 89 82 77	85 80 75	81 77 73	78 75 71	69									
3	90 80 72 65	88 78 71 65	75 69 63	72 67 62	69 65 61	59									
4	83 71 62 56	80 69 61 55	67 60 54	64 58 53	62 57 52	50									
5	76 63 55 48	74 62 54 48	60 53 47	58 51 46	56 50 46	44									
6	70 57 48 42	68 56 48 42	54 47 41	52 46 41	51 45 40	38									
7	65 52 43 37	63 51 43 37	49 42 37	48 41 36	46 40 36	34									
8	61 47 39 33	59 47 39 33	45 38 33	44 37 32	43 37 32	30									
9	57 44 35 30	55 43 35 30	42 35 30	40 34 29	39 33 29	27									
10	53 40 32 27	52 40 32 27	39 32 27	37 31 27	37 31 26	25									

iW Cove MX Powercore 1 ft (305 mm), 110° x 110° beam angle 4000 K channel only

Lumens	243
Efficacy	27.2 lm / W

Polar Candela Distribution

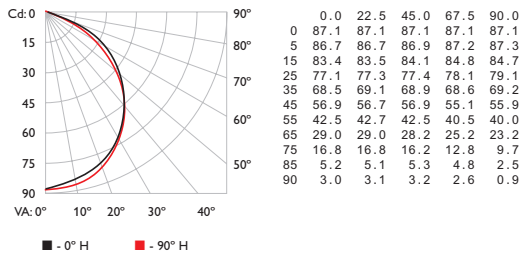

Illuminance at Distance

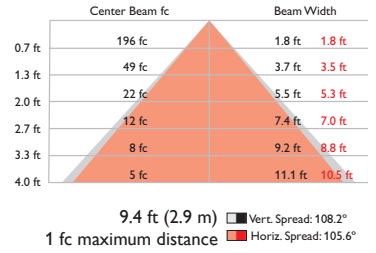

Zonal Lumen

ZONE	LUMENS	%FIXT
0- 30	67.8	27.9
0- 40	110.8	45.6
0- 60	191.5	78.8
0- 90	239.6	98.5
90-120	3.3	1.3
90-130	3.5	1.4
90-150	3.6	1.5
90-180	3.6	1.5
0-180	243.2	100.0

Coefficients Of Utilization - Zonal Cavity Method

RC	Effective Floor Cavity Reflectance: 20%														
	80			70			50			30			10	0	
RW	70	50	30	10	70	50	30	10	50	30	10	50	30	10	0
0	119119119119	116116116116	1101101101	105105105	101101101	99									
1	108104 99 96	106101 97 94	97 94 91	93 90 88	89 87 85	82									
2	99 91 84 78	96 89 82 77	85 80 75	81 77 73	78 74 71	69									
3	90 80 72 65	88 78 70 64	75 68 63	72 66 62	69 65 61	58									
4	83 71 62 55	80 69 61 55	67 60 54	64 58 53	62 57 52	50									
5	76 63 54 48	74 62 54 47	60 52 47	58 51 46	56 50 45	43									
6	70 57 48 42	68 56 48 42	54 47 41	52 46 41	50 45 40	38									
7	65 52 43 37	63 51 43 37	49 42 36	48 41 36	46 40 36	34									
8	61 47 39 33	59 46 38 33	45 38 33	44 37 32	42 36 32	30									
9	57 43 35 30	55 43 35 30	41 34 29	40 34 29	39 33 29	27									
10	53 40 32 27	52 39 32 27	38 31 27	37 31 26	36 30 26	25									

For lux multiply fc by 10.7

iW Cove MX Powercore
1 ft (305 mm), 110° x 110° beam angle
6500 K channel only

Lumens	271
Efficacy	31.2 lm / W

Polar Candela Distribution

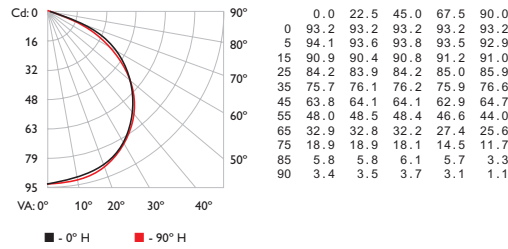

Illuminance at Distance

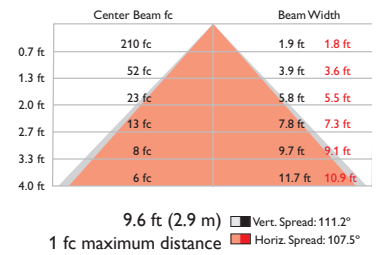

Zonal Lumen

ZONE	LUMENS	%FIXT
0- 30	73.6	27.1
0- 40	121.1	44.7
0- 60	212.5	78.4
0- 90	266.8	98.5
90-120	3.7	1.4
90-130	4.0	1.5
90-150	4.1	1.5
90-180	4.2	1.5
0-180	271.0	100.0

Coefficients Of Utilization - Zonal Cavity Method

RC	Effective Floor Cavity Reflectance: 20%														
	80			70			50			30			10		
RW	70	50	30	10	70	50	30	10	50	30	10	50	30	10	0
0	119119119119	116116116116	110110110	105105105	101101101	98									
1	108104 99 95	105101 97 94	97 93 90	92 90 87	89 86 84	82									
2	99 90 83 78	96 88 82 77	84 79 75	81 77 73	78 74 71	69									
3	90 79 71 65	87 78 70 64	74 68 63	72 66 61	69 64 60	58									
4	82 70 62 55	80 69 61 54	66 59 54	64 58 53	61 56 52	50									
5	76 63 54 47	74 62 53 47	59 52 46	57 51 46	55 50 45	43									
6	70 57 48 41	68 56 47 41	54 46 41	52 45 40	50 44 40	38									
7	65 51 43 36	63 50 42 36	49 41 36	47 41 36	46 40 35	33									
8	60 47 38 33	59 46 38 32	45 37 32	43 37 32	42 36 31	30									
9	56 43 35 29	55 42 34 29	41 34 29	40 33 29	39 33 28	27									
10	53 40 32 26	51 39 31 26	38 31 26	37 31 26	36 30 26	24									

iW Cove MX Powercore
1 ft (305 mm), 110° x 110° beam angle
All channels full on

Lumens	656
Efficacy	37.3 lm / W

Polar Candela Distribution

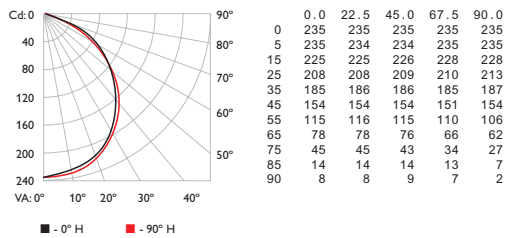

Illuminance at Distance

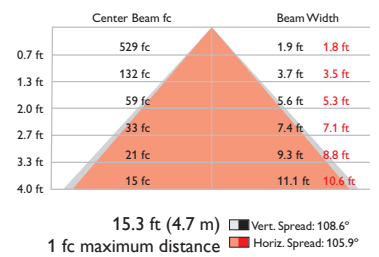

Zonal Lumen

ZONE	LUMENS	%FIXT
0- 30	183	27.8
0- 40	299	45.5
0- 60	517	78.9
0- 90	646	98.5
90-120	9	1.4
90-130	10	1.5
90-150	10	1.5
90-180	10	1.5
0-180	656	100.0

Coefficients Of Utilization - Zonal Cavity Method

RC	Effective Floor Cavity Reflectance: 20%														
	80			70			50			30			10		
RW	70	50	30	10	70	50	30	10	50	30	10	50	30	10	0
0	119119119119	116116116116	110110110	105105105	101101101	98									
1	108104 99 96	106101 97 94	97 94 91	93 90 88	89 87 85	82									
2	99 91 84 78	96 89 82 77	85 80 75	81 77 73	78 74 71	69									
3	90 80 72 65	88 78 71 64	75 68 63	72 66 62	69 65 61	58									
4	83 71 62 55	80 69 61 55	67 60 54	64 58 53	62 57 52	50									
5	76 63 54 48	74 62 54 47	60 52 47	58 51 46	56 50 45	43									
6	70 57 48 42	68 56 48 42	54 47 41	52 46 41	50 45 40	38									
7	65 52 43 37	63 51 43 37	49 42 36	48 41 36	46 40 36	34									
8	61 47 39 33	59 46 38 33	45 38 33	44 37 32	42 36 32	30									
9	57 43 35 30	55 43 35 30	41 34 29	40 34 29	39 33 29	27									
10	53 40 32 27	52 39 32 27	38 31 27	37 31 26	36 30 26	24									

For lux multiply fc by 10.7

iW Cove MX Powercore
1 ft (305 mm), 50° x 70° beam angle
2700 K channel only

Lumens	136
Efficacy	15.9 lm / W

Polar Candela Distribution

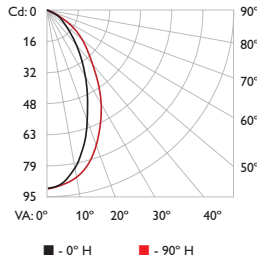

Cd:0	0.0	22.5	45.0	67.5	90.0
0	90.6	90.6	90.6	90.6	90.6
5	88.8	88.9	89.2	89.4	89.4
15	73.2	74.3	77.3	80.0	81.3
25	51.2	53.1	58.3	63.7	66.2
35	32.7	34.5	39.5	45.2	47.8
45	20.2	21.5	25.1	29.3	30.9
55	12.4	13.2	15.3	17.8	18.7
65	7.5	7.9	9.0	10.2	10.5
75	4.4	4.5	4.9	5.0	4.9
85	2.4	2.4	2.1	1.5	1.0
90	1.8	1.7	1.4	0.7	0.2

Illuminance at Distance

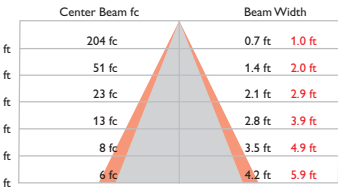

9.5 ft (2.9 m) Vert. Spread: 55.7°
1 fc maximum distance Horiz. Spread: 72.8°

Zonal Lumen

ZONE	LUMENS	%FIXT
0- 30	56.7	41.8
0- 40	81.7	60.1
0- 60	115.3	84.9
0- 90	131.6	96.9
90-120	2.6	1.9
90-130	3.3	2.4
90-150	4.0	3.0
90-180	4.2	3.1
0-180	135.8	100.0

Coefficients Of Utilization - Zonal Cavity Method

RC	80				70				50				Effective Floor Cavity Reflectance: 20%					
	70	50	30	10	70	50	30	10	50	30	10	50	30	10	50	30	10	
0	118118118118	118118118118	115115115115	115115	109109109	104104104	99	99	99	97								
1	110106102	99	107103100	97	98	96	93	94	92	90	90	88	87	85				
2	102	95	89	84	99	92	87	83	89	84	80	85	81	78	82	79	76	74
3	94	85	78	73	92	83	77	72	80	75	70	77	72	69	74	70	67	65
4	87	77	70	64	85	76	69	63	73	67	62	70	65	61	68	64	60	58
5	81	70	62	57	79	69	62	56	67	60	55	64	59	55	62	58	54	52
6	76	64	57	51	74	63	56	51	61	55	50	59	54	49	58	53	49	47
7	71	59	52	46	69	58	51	46	57	50	45	55	49	45	54	48	44	43
8	67	55	47	42	65	54	47	42	53	46	42	51	45	41	50	45	41	39
9	63	51	44	39	62	50	43	39	49	43	38	48	42	38	47	41	38	36
10	59	48	40	36	58	47	40	36	46	40	35	45	39	35	44	39	35	33

iW Cove MX Powercore
1 ft (305 mm), 50° x 70° beam angle
4000 K channel only

Lumens	167
Efficacy	19.5 lm / W

Polar Candela Distribution

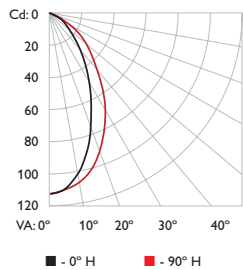

Cd:0	0.0	22.5	45.0	67.5	90.0
0	111	111	111	111	111
5	109	109	110	110	110
15	90	91	95	99	100
25	63	65	72	78	81
35	40	42	49	56	59
45	25	27	31	36	38
55	15	16	19	22	23
65	9	10	11	13	13
75	5	6	6	6	6
85	3	3	3	2	1
90	2	2	2	1	0

Illuminance at Distance

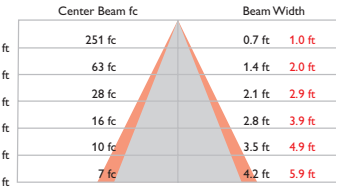

10.6 ft (3.2 m) Vert. Spread: 55.7°
1 fc maximum distance Horiz. Spread: 72.8°

Zonal Lumen

ZONE	LUMENS	%FIXT
0- 30	70	41.7
0- 40	100	60.1
0- 60	142	85.0
0- 90	162	97.1
90-130	4	2.3
90-150	5	2.8
90-180	5	2.9
0-180	167	100.0

Coefficients Of Utilization - Zonal Cavity Method

RC	80				70				50				Effective Floor Cavity Reflectance: 20%					
	70	50	30	10	70	50	30	10	50	30	10	50	30	10	50	30	10	
0	118118118118	118118118118	115115115115	115115	109109109	104104104	99	99	99	97								
1	110106102	99	107103100	97	98	96	93	94	92	90	90	88	87	85				
2	102	95	89	84	99	93	87	83	89	84	80	85	81	78	82	79	76	74
3	94	85	78	73	92	83	77	72	80	75	70	77	73	69	74	70	67	65
4	87	77	70	64	85	76	69	63	73	67	62	70	65	61	68	64	60	58
5	81	70	62	57	79	69	62	56	67	60	55	64	59	55	62	58	54	52
6	76	64	57	51	74	63	56	51	61	55	50	59	54	49	58	53	49	47
7	71	59	52	46	69	58	51	46	57	50	45	55	49	45	54	48	44	43
8	67	55	47	42	65	54	47	42	53	46	42	51	45	41	50	45	41	39
9	63	51	44	39	62	50	43	39	49	43	38	48	42	38	47	41	38	36
10	59	48	40	36	58	47	40	36	46	40	35	45	39	35	44	39	35	33

For lux multiply fc by 10.7

iW Cove MX Powercore
1 ft (305 mm), 50° x 70° beam angle
6500 K channel only

Lumens	187
Efficacy	22.1 lm / W

Polar Candela Distribution

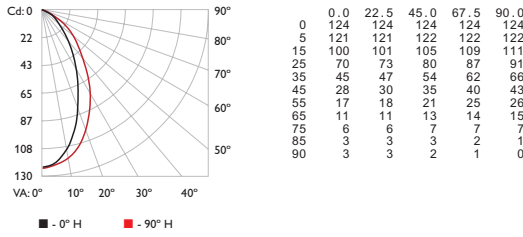

Illuminance at Distance

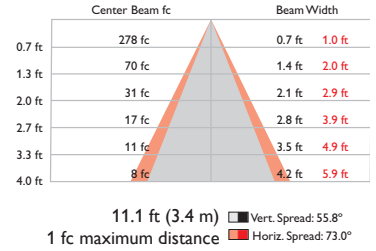

Zonal Lumen

ZONE	LUMENS	%FIXT
0- 30	78	41.4
0- 40	112	59.6
0- 60	158	84.5
0- 90	181	96.8
90-120	4	2.0
90-130	5	2.5
90-150	6	3.1
90-180	6	3.2
0-180	187	100.0

Coefficients Of Utilization - Zonal Cavity Method

RC	Effective Floor Cavity Reflectance: 20%																	
	80			70			50			30			10					
RW	70	50	30	10	70	50	30	10	50	30	10	50	30	10	50	30	10	
0	118	118	118	118	115	115	115	115	109	109	109	104	104	104	99	99	99	97
1	110	106	102	99	107	103	100	97	98	96	93	94	92	90	90	88	87	84
2	101	94	89	84	99	92	87	82	88	84	80	85	81	78	81	78	76	74
3	94	85	78	72	91	83	77	72	80	74	70	77	72	68	74	70	67	65
4	87	77	69	64	85	75	68	63	73	67	62	70	65	61	68	63	60	58
5	81	70	62	56	79	69	61	56	66	60	55	64	59	54	62	57	53	52
6	76	64	56	51	74	63	56	50	61	55	50	59	53	49	57	52	48	47
7	71	59	51	46	69	58	51	46	56	50	45	55	49	45	53	48	44	42
8	67	55	47	42	65	54	47	42	52	46	41	51	45	41	50	44	40	39
9	63	51	43	38	61	50	43	38	49	42	38	48	42	38	46	41	37	36
10	59	47	40	35	58	47	40	35	46	39	35	45	39	35	44	38	35	33

iW Cove MX Powercore
1 ft (305 mm), 50° x 70° beam angle
All channels full on

Lumens	458
Efficacy	27.6 lm / W

Polar Candela Distribution

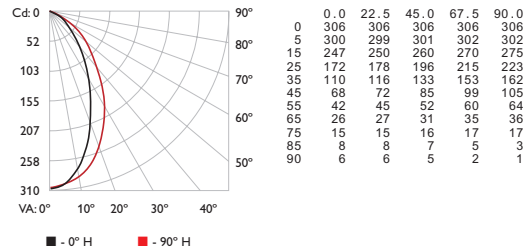

Illuminance at Distance

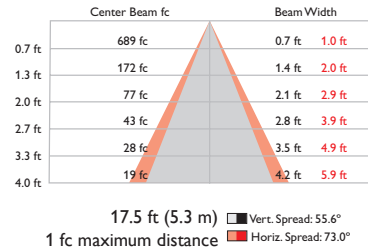

Zonal Lumen

ZONE	LUMENS	%FIXT
0- 30	191	41.7
0- 40	275	60.1
0- 60	389	85.0
0- 90	445	97.1
90-120	9	1.9
90-130	10	2.3
90-150	13	2.8
90-180	13	2.9
0-180	458	100.0

Coefficients Of Utilization - Zonal Cavity Method

RC	Effective Floor Cavity Reflectance: 20%																	
	80			70			50			30			10					
RW	70	50	30	10	70	50	30	10	50	30	10	50	30	10	50	30	10	
0	118	118	118	118	115	115	115	115	110	110	110	104	104	104	99	99	99	97
1	110	106	102	99	107	103	100	97	99	96	93	94	92	90	90	89	87	85
2	102	95	89	84	99	93	87	83	89	84	80	85	81	78	82	79	76	74
3	94	85	78	73	92	83	77	72	80	75	70	77	73	69	74	71	67	65
4	87	77	70	64	85	76	69	63	73	67	62	70	65	61	68	64	60	58
5	81	70	62	57	79	69	62	56	67	60	55	65	59	55	63	58	54	52
6	76	64	57	51	74	63	56	50	61	55	50	60	54	49	58	53	49	47
7	71	59	52	46	69	58	51	46	57	50	45	55	49	45	54	48	44	43
8	67	55	47	42	65	54	47	42	53	46	42	51	45	41	50	45	41	39
9	63	51	44	39	62	50	43	39	49	43	38	48	42	38	47	41	38	36
10	59	48	40	36	58	47	40	36	46	40	35	45	39	35	44	39	35	33

For lux multiply fc by 10.7

iW Cove MX Powercore
4 ft (1.2 m), 110° x 110° beam angle
2700 K channel only

Lumens	727
Efficacy	35.1 lm / W

Polar Candela Distribution

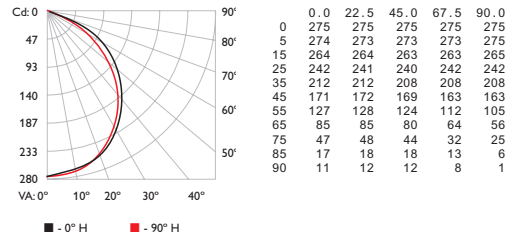

Illuminance at Distance

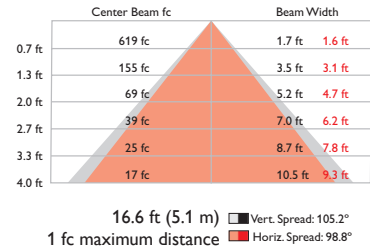

Zonal Lumen

ZONE	LUMENS	%FIXT
0- 30	211	29.1
0- 40	342	47.1
0- 60	579	79.7
0- 90	714	98.2
90-120	12	1.7
90-130	13	1.8
90-150	13	1.8
90-180	13	1.8
0-180	727	100.0

Coefficients Of Utilization - Zonal Cavity Method

RC	Effective Floor Cavity Reflectance: 20%														
	80			70			50			30			10		
RW	70	50	30	10	70	50	30	10	50	30	10	50	30	10	0
0	119119119119	119119119119	116116116116	116116116116	110110110	105105105	100100100	98							
1	109104100	96	106101	98	94	97	94	91	93	90	88	89	87	85	83
2	99	91	84	79	96	89	83	78	85	80	76	82	77	74	69
3	91	80	72	66	88	79	71	65	75	69	64	72	67	63	59
4	83	71	63	56	81	70	62	56	67	60	55	65	59	54	51
5	77	64	55	49	74	63	55	48	60	53	48	58	52	47	44
6	71	58	49	43	69	57	48	42	55	47	42	53	46	41	39
7	66	52	44	38	64	52	43	38	50	43	37	48	42	37	35
8	61	48	40	34	60	47	39	34	46	39	33	44	38	33	31
9	57	44	36	31	56	43	36	30	42	35	30	41	35	30	28
10	54	41	33	28	52	40	33	28	39	32	27	38	32	27	25

iW Cove MX Powercore
4 ft (1.2 m), 110° x 110° beam angle
4000 K channel only

Lumens	896
Efficacy	43.3 lm / W

Polar Candela Distribution

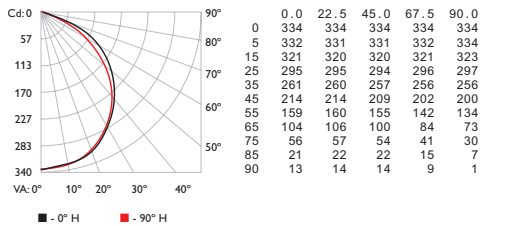

Illuminance at Distance

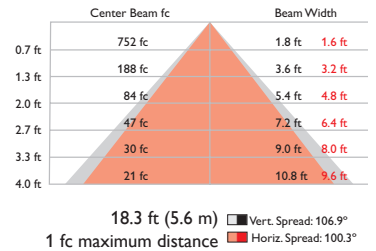

Zonal Lumen

ZONE	LUMENS	%FIXT
0- 30	258	28.8
0- 40	419	46.8
0- 60	714	79.7
0- 90	882	98.4
90-120	14	1.5
90-130	14	1.6
90-150	14	1.6
90-180	14	1.6
0-180	896	100.0

Coefficients Of Utilization - Zonal Cavity Method

RC	Effective Floor Cavity Reflectance: 20%														
	80			70			50			30			10		
RW	70	50	30	10	70	50	30	10	50	30	10	50	30	10	0
0	119119119119	119119119119	116116116116	116116116116	110110110	105105105	101101101	98							
1	109104100	96	106101	98	94	97	94	91	93	90	88	89	87	85	83
2	99	91	84	79	96	89	83	78	85	80	76	82	77	74	69
3	91	80	72	66	88	78	71	65	75	69	64	72	67	62	59
4	83	71	63	56	81	70	62	56	67	60	55	65	59	54	51
5	76	64	55	49	74	63	54	48	60	53	48	58	52	47	44
6	71	58	49	43	69	57	48	42	55	47	42	53	46	41	39
7	66	52	44	38	64	51	43	37	50	42	37	48	42	37	34
8	61	48	39	34	59	47	39	34	46	38	33	44	38	33	31
9	57	44	36	30	56	43	36	30	42	35	30	41	34	30	28
10	54	41	33	28	52	40	32	27	39	32	27	38	32	27	25

For lux multiply fc by 10.7

iW Cove MX Powercore
4 ft (1.2 m), 110° x 110° beam angle
6500 K channel only

Lumens	1003
Efficacy	48.5 lm / W

Polar Candela Distribution

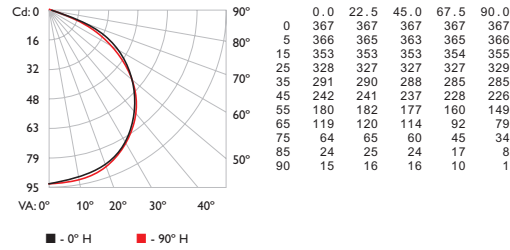

Illuminance at Distance

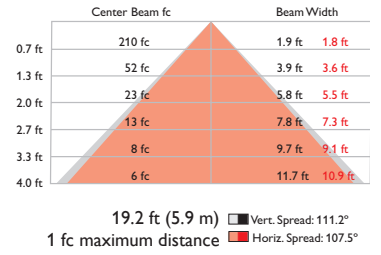

Zonal Lumen

ZONE	LUMENS	%FIXT
0- 30	285	28.4
0- 40	465	46.4
0- 60	799	79.6
0- 90	986	98.4
90-120	16	1.6
90-130	16	1.6
90-150	17	1.6
90-180	17	1.6
0-180	1003	100.0

Coefficients Of Utilization - Zonal Cavity Method

RC	Effective Floor Cavity Reflectance: 20%																	
	80			70			50			30			10			0		
RW	70	50	30	10	70	50	30	10	50	30	10	50	30	10	50	30	10	0
0	1191	191	191	119	1161	161	161	116	1101	101	101	1051	105	105	101	101	101	98
1	1091	041	00	96	1061	01	98	94	97	94	91	93	90	88	89	87	85	83
2	99	91	84	79	96	89	83	78	85	80	75	82	77	73	78	75	72	69
3	90	80	72	66	88	78	71	65	75	69	64	72	67	62	69	65	61	59
4	83	71	63	56	81	70	62	55	67	60	55	65	59	54	62	57	53	51
5	76	64	55	48	74	63	54	48	60	53	47	58	52	47	56	51	46	44
6	71	57	49	42	69	56	48	42	54	47	42	53	46	41	51	45	41	39
7	66	52	44	37	64	51	43	37	50	42	37	48	41	37	47	41	36	34
8	61	48	39	33	59	47	39	33	45	38	33	44	38	33	43	37	32	31
9	57	44	36	30	56	43	35	30	42	35	30	41	34	30	40	34	29	27
10	53	40	33	27	52	40	32	27	39	32	27	38	31	27	37	31	27	25

iW Cove MX Powercore
4 ft (1.2 m), 110° x 110° beam angle
All channels full on

Lumens	2471
Efficacy	48.6 lm / W

Polar Candela Distribution

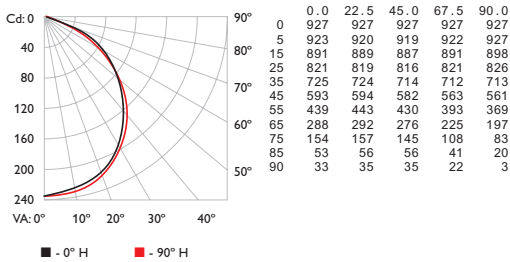

Illuminance at Distance

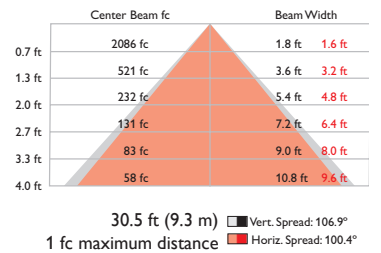

Zonal Lumen

ZONE	LUMENS	%FIXT
0- 30	717	29.0
0- 40	1165	47.1
0- 60	1984	80.3
0- 90	2437	98.7
90-120	32	1.3
90-130	33	1.3
90-150	33	1.3
90-180	33	1.3
0-180	2471	100.0

Coefficients Of Utilization - Zonal Cavity Method

RC	Effective Floor Cavity Reflectance: 20%																	
	80			70			50			30			10			0		
RW	70	50	30	10	70	50	30	10	50	30	10	50	30	10	50	30	10	0
0	1191	191	191	119	1161	161	161	116	1101	101	101	1051	105	105	101	101	101	99
1	1091	041	00	96	1061	02	98	94	97	94	91	93	90	88	89	87	85	83
2	99	91	85	79	96	89	83	78	85	80	76	82	78	74	79	75	72	70
3	91	80	72	66	88	79	71	65	76	69	64	73	67	63	70	65	62	59
4	83	72	63	56	81	70	62	56	67	60	55	65	59	54	63	58	53	51
5	77	64	55	49	74	63	55	48	61	53	48	59	52	47	57	51	47	44
6	71	58	49	43	69	57	49	42	55	48	42	53	47	42	51	46	41	39
7	66	53	44	38	64	52	43	38	50	43	37	48	42	37	47	41	37	35
8	61	48	40	34	60	47	39	34	46	39	33	44	38	33	43	37	33	31
9	57	44	36	31	56	43	36	30	42	35	30	41	35	30	40	34	30	28
10	54	41	33	28	52	40	33	28	39	32	27	38	32	27	37	31	27	25

For lux multiply fc by 10.7

iW Cove MX Powercore
4 ft (1.2 m), 50° x 70° beam angle
2700 K channel only

Lumens	514
Efficacy	25.1 lm / W

Polar Candela Distribution

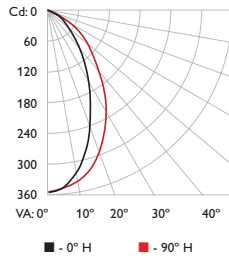

90°	0.0	22.5	45.0	67.5	90.0
80°	0	352	352	352	352
	5	345	344	346	347
	15	283	286	298	311
70°	25	196	203	223	248
	35	124	131	151	176
	45	76	81	95	114
	55	46	49	58	69
60°	65	27	29	34	40
	75	15	16	18	19
	85	8	8	7	5
50°	90	6	5	4	2

Illuminance at Distance

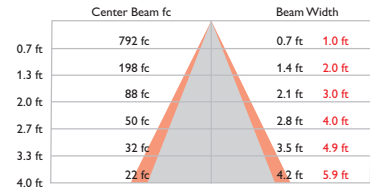

18.8 ft (5.7 m) Vert. Spread: 55.0°
 1 fc maximum distance Horiz. Spread: 73.1°

Zonal Lumen

ZONE	LUMENS	%FIXT
0- 30	219	42.6
0- 40	315	61.3
0- 60	444	86.3
0- 90	503	97.9
90-120	7	1.3
90-130	8	1.6
90-150	10	2.0
90-180	11	2.1
0-180	514	100.0

Coefficients Of Utilization - Zonal Cavity Method

RC	80			70			50			30			10			0		
	70	50	30	10	70	50	30	10	50	30	10	50	30	10				
0	1191	1911	1911	9	1161	1611	1611	6	1101	1011	10	1051	1051	10	1001	1001	0	98
1	1101	1061	103	99	1071	1041	100	98	99	97	94	95	93	91	91	89	88	86
2	102	95	89	85	99	93	88	83	89	85	81	86	82	79	83	80	77	75
3	95	86	79	73	92	84	78	72	81	75	71	78	73	70	75	71	68	66
4	88	78	70	64	86	76	69	64	74	68	63	71	66	62	69	64	61	59
5	82	71	63	57	80	70	62	57	67	61	56	65	60	55	63	59	55	53
6	77	65	57	52	75	64	57	51	62	56	51	60	55	50	59	54	50	48
7	72	60	52	47	70	59	52	47	57	51	46	56	50	46	54	49	45	43
8	67	55	48	43	66	55	47	43	53	47	42	52	46	42	51	45	41	40
9	63	51	44	39	62	51	44	39	50	43	39	48	43	39	47	42	38	37
10	60	48	41	36	59	48	41	36	46	40	36	45	40	36	44	39	35	34

iW Cove MX Powercore
4 ft (1.2 m), 50° x 70° beam angle
4000 K channel only

Lumens	615
Efficacy	30.0 lm / W

Polar Candela Distribution

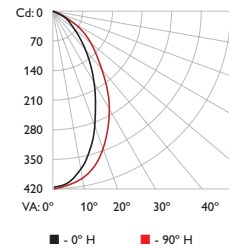

90°	0.0	22.5	45.0	67.5	90.0
80°	0	418	418	418	418
	5	409	409	409	412
	15	336	341	354	369
70°	25	234	242	266	295
	35	149	157	180	210
	45	91	97	114	136
	55	55	59	70	82
60°	65	33	35	41	47
	75	19	20	21	23
	85	10	10	9	6
50°	90	7	7	5	2

Illuminance at Distance

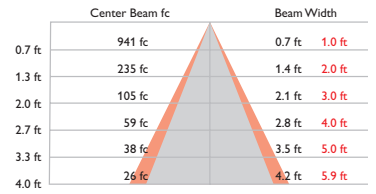

20.4 ft (6.2 m) Vert. Spread: 55.4°
 1 fc maximum distance Horiz. Spread: 73.2°

Zonal Lumen

ZONE	LUMENS	%FIXT
0- 30	261	42.4
0- 40	376	61.0
0- 60	530	86.1
0- 90	602	97.9
90-120	9	1.4
90-130	11	1.7
90-150	13	2.1
90-180	13	2.1
0-180	615	100.0

Coefficients Of Utilization - Zonal Cavity Method

RC	80			70			50			30			10			0		
	70	50	30	10	70	50	30	10	50	30	10	50	30	10				
0	1191	1911	1911	9	1161	1611	1611	6	1101	1011	10	1051	1051	10	1001	1001	0	98
1	1101	1061	102	99	1071	1041	100	97	99	96	94	95	93	91	91	89	88	86
2	102	95	89	84	99	93	88	83	89	85	81	86	82	79	83	80	77	75
3	94	86	79	73	92	84	77	72	81	75	71	78	73	69	75	71	68	66
4	88	78	70	64	86	76	69	64	73	67	63	71	66	62	69	64	61	59
5	82	71	63	57	80	69	62	57	67	61	56	65	60	55	63	58	55	53
6	76	65	57	51	75	64	56	51	62	55	50	60	54	50	58	53	49	48
7	72	60	52	47	70	59	52	46	57	51	46	56	50	45	54	49	45	43
8	67	55	48	43	66	54	47	42	53	47	42	52	46	42	50	45	41	40
9	63	51	44	39	62	51	44	39	49	43	39	48	43	38	47	42	38	36
10	60	48	41	36	59	47	41	36	46	40	36	45	40	36	44	39	35	34

For lux multiply fc by 10.7

iW Cove MX Powercore
4 ft (1.2 m), 50° x 70° beam angle
6500 K channel only

Lumens	702
Efficacy	34.4 lm / W

Polar Candela Distribution

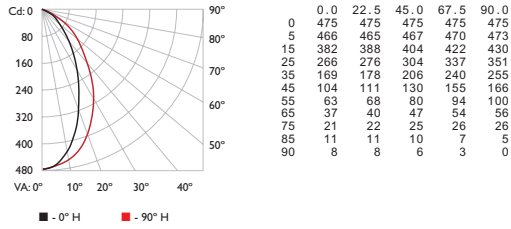

Illuminance at Distance

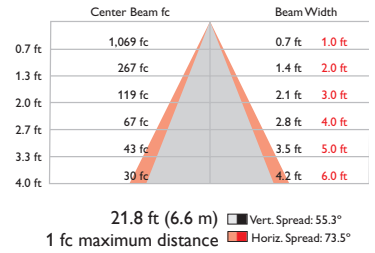

Zonal Lumen

ZONE	LUMENS	%FIXT
0- 30	297	42.4
0- 40	428	61.0
0- 60	604	86.1
0- 90	687	97.9
90-120	10	1.4
90-130	12	1.7
90-150	14	2.1
90-180	15	2.1
0-180	702	100.0

Coefficients Of Utilization - Zonal Cavity Method

RC	Effective Floor Cavity Reflectance: 20%																									
	80				70				50				30				10				0					
RW	70	50	30	10	70	50	30	10	50	30	10	50	30	10	50	30	10	50	30	10	50	30	10	50	30	10
0	1191	191	191	119	1161	161	161	116	1101	1011	101	1051	1051	105	1001	1001	100	100	100	100	100	100	100	100	100	
1	1101	106	102	99	107	104	100	97	99	96	94	95	93	91	91	89	88	86	86	86	86	86	86	86	86	
2	102	95	89	84	99	93	88	83	89	85	81	86	82	79	83	80	77	75	75	75	75	75	75	75	75	
3	94	86	79	73	92	84	77	72	81	75	71	78	73	69	75	71	68	66	66	66	66	66	66	66	66	
4	88	78	70	64	86	76	69	64	73	67	63	71	66	62	69	64	61	59	59	59	59	59	59	59	59	
5	82	71	63	57	80	69	62	57	67	61	56	65	60	55	63	58	55	53	53	53	53	53	53	53	53	
6	76	65	57	51	75	64	56	51	62	55	50	60	54	50	58	53	49	48	48	48	48	48	48	48	48	
7	72	60	52	47	70	59	52	46	57	51	46	56	50	45	54	49	45	43	43	43	43	43	43	43	43	
8	67	55	48	43	66	54	47	42	53	47	42	52	46	42	51	45	41	40	40	40	40	40	40	40	40	
9	63	51	44	39	62	51	44	39	49	43	39	48	43	38	47	42	38	36	36	36	36	36	36	36	36	
10	60	48	41	36	59	47	41	36	46	40	36	45	40	36	44	39	35	34	34	34	34	34	34	34	34	

iW Cove MX Powercore
4 ft (1.2 m), 50° x 70° beam angle
All channels full on

Lumens	1726
Efficacy	34.4 lm / W

Polar Candela Distribution

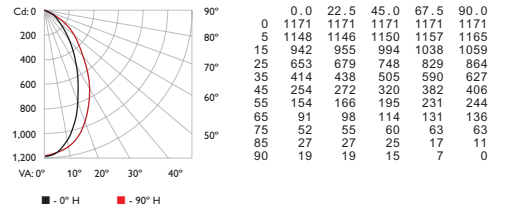

Illuminance at Distance

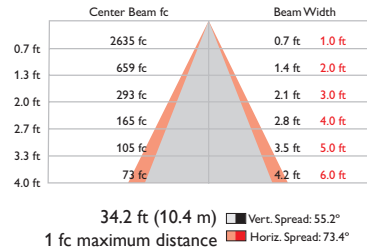

Zonal Lumen

ZONE	LUMENS	%FIXT
0- 30	732	42.4
0- 40	1053	61.0
0- 60	1485	86.0
0- 90	1688	97.8
90-120	24	1.4
90-130	30	1.7
90-150	37	2.1
90-180	38	2.2
0-180	1726	100.0

Coefficients Of Utilization - Zonal Cavity Method

RC	Effective Floor Cavity Reflectance: 20%																									
	80				70				50				30				10				0					
RW	70	50	30	10	70	50	30	10	50	30	10	50	30	10	50	30	10	50	30	10	50	30	10	50	30	10
0	1191	191	191	119	1161	161	161	116	1101	1011	101	1051	1051	105	1001	1001	100	100	100	100	100	100	100	100	100	
1	1101	106	102	99	107	104	100	97	99	96	94	95	93	91	91	89	88	86	86	86	86	86	86	86	86	
2	102	95	89	84	99	93	88	83	89	85	81	86	82	79	82	80	77	75	75	75	75	75	75	75	75	
3	94	86	79	73	92	84	77	72	81	75	71	78	73	69	75	71	68	66	66	66	66	66	66	66	66	
4	88	78	70	64	86	76	69	64	73	67	63	71	66	62	69	64	61	59	59	59	59	59	59	59	59	
5	82	71	63	57	80	69	62	57	67	61	56	65	60	55	63	58	55	53	53	53	53	53	53	53	53	
6	76	65	57	51	75	64	56	51	62	55	50	60	54	50	58	53	49	48	48	48	48	48	48	48	48	
7	72	60	52	47	70	59	52	46	57	51	46	56	50	45	54	49	45	43	43	43	43	43	43	43	43	
8	67	55	48	43	66	55	47	42	53	47	42	52	46	42	50	45	41	40	40	40	40	40	40	40	40	
9	63	51	44	39	62	51	44	39	49	43	39	48	43	38	47	42	38	36	36	36	36	36	36	36	36	
10	60	48	41	36	59	47	41	36	46	40	36	45	40	36	44	39	35	34	34	34	34	34	34	34	34	

For lux multiply fc by 10.7

iW Cove MX Powercore Specifications: 1 ft (305 mm)

Due to continuous improvements and innovations, specifications may change without notice.

Item	Beam Angle	2700 K*	4000 K*	6500 K*	All Channels
Lumens†	110° x 110°	184	243	271	656
	50° x 70°	136	167	187	458
Efficacy (lm / W)	110° x 110°	20.9	27.2	31.2	37.3
	50° x 70°	15.9	19.5	22.1	27.6
CRI	110° x 110°	85	81	73	82
	50° x 70°	83	83	75	82

Item	Specification	Details
Output	Lumen Maintenance‡	50,000 hours L70 @ 25° C 50,000 hours L70 @ 50° C 50,000 hours L50 @ 25° C 50,000 hours L50 @ 50° C
Electrical	Input Voltage	100 – 240 VAC, auto-switching, 50 / 60 Hz
	Power Consumption	13 W maximum at full output, steady state
Control	Interface	Data Enabler Pro (DMX / Ethernet)
	Control System	Philips Color Kinetics full range of controllers, including Light System Manager, iPlayer 3, and ColorDial Pro, or third-party controllers
Physical	Dimensions (Height x Width x Depth)	1.6 x 12 x 1.5 in 42 x 305 x 39 mm (110° x 110°) 2.0 x 12 x 1.5 in 51 x 305 x 39 mm (50° x 70°)
	Weight	0.82 lb (372 g) (110° x 110°) 1 lb (454 g) (50° x 70°)
	Housing	Die-cast aluminium, white powder-coated finish.
	Lens	Clear polycarbonate
	Fixture Connections	Integral male / female connectors
	Temperature Ranges	-4° – 122° F (-20° – 50° C) Operating -4° – 122° F (-20° – 50° C) Startup -40° – 176° F (-40° – 80° C) Storage
	Humidity	0 – 95%, non-condensing
	Fixture Run Lengths	To calculate fixture run lengths and total power consumption for your specific installation, download the Configuration Calculator from www.philipscolorkinetics.com/support/install_tool/
Certification and Safety	Certification	UL / cUL, FCC Class B, CE, PSE, CCC, SAA, C-Tick
	Environment	Dry / Damp Location, IP20

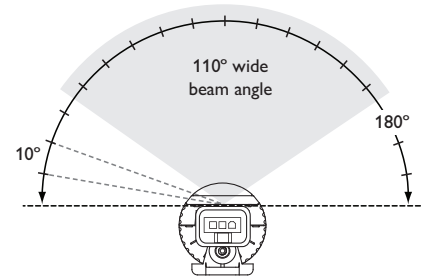

Wide beam angle (110° x 110°)

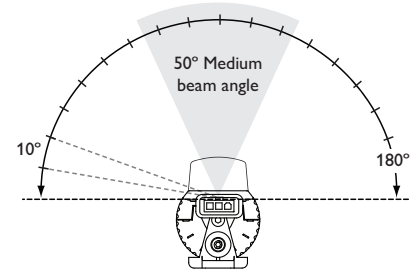

Medium beam angle (50° x 70°)

* Color temperatures conform to nominal CCTs as defined in ANSI Chromaticity Standard C78.377A.



† Lumen measurement complies with IES LM-79-08 testing procedures.

‡ L70 = 70% lumen maintenance (when light output drops below 70% of initial output).
L50 = 50% lumen maintenance (when light output drops below 50% of initial output).

Ambient luminaire temperatures specified. Lumen maintenance calculations are based on lifetime prediction graphs supplied by LED source manufacturers. Calculations for white-light LED fixtures are based on measurements that comply with IES LM-80-08 testing procedures. Refer to www.philipscolorkinetics.com/support/appnotes/lm-80-08.pdf for more information.

CHROMACORE[®] | OPTIBIN[®] | POWERCORE[®]
CKTECHNOLOGY | CKTECHNOLOGY | CKTECHNOLOGY

Wide beam angle

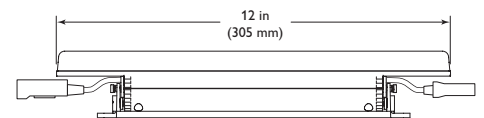
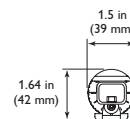

Medium beam angle

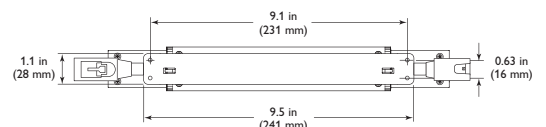
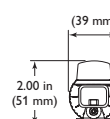

iW Cove MX Powercore Specifications: 4 ft (1.2 m)

Due to continuous improvements and innovations, specifications may change without notice.

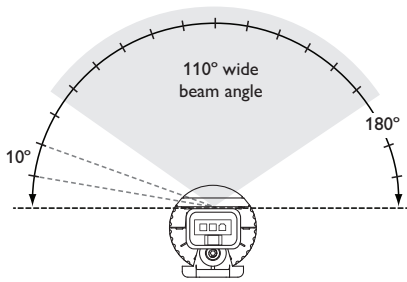

Wide beam angle (110° x 110°)

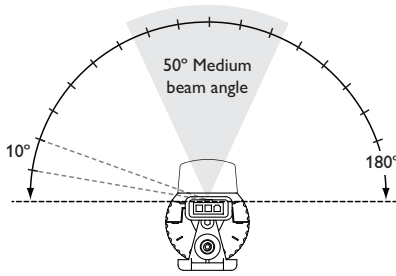

Medium beam angle (50° x 70°)

Item	Beam Angle	2700 K*	4000 K*	6500 K*	All Channels
Lumens†	110° x 110°	727	896	1003	2471
	50° x 70°	514	615	702	1726
Efficacy (lm / W)	110° x 110°	35.1	43.3	48.5	48.6
	50° x 70°	25.1	30.0	34.4	34.4
CRI	110° x 110°	82	81	73	81
	50° x 70°	82	81	74	82

Item	Specification	Details
Output	Lumen Maintenance‡	50,000 hours L70 @ 25° C 50,000 hours L70 @ 50° C 50,000 hours L50 @ 25° C 50,000 hours L50 @ 50° C
	Input Voltage	100 – 240 VAC, auto-switching, 50 / 60 Hz
Electrical	Power Consumption	50 W maximum at full output, steady state
	Interface	Data Enabler Pro (DMX / Ethernet)
Control	Control System	Philips Color Kinetics full range of controllers, including Light System Manager, iPlayer 3, and ColorDial Pro, or third-party controllers
	Dimensions (Height x Width x Depth)	1.64 x 48 x 1.5 in 42 x 1219 x 38 mm (110° x 110°) 2.00 x 48 x 1.5 in 51 x 1219 x 38 mm (50° x 70°)
Physical	Weight	4.1 lb (1.85 kg) (110° x 110°) 4.6 lb (2.1 kg) (50° x 70°)
	Housing	Die-cast aluminium, white powder-coated finish.
	Lens	Clear polycarbonate
	Fixture Connections	Integral male / female connectors
	Temperature Ranges	-4° – 122° F (-20° – 50° C) Operating -4° – 122° F (-20° – 50° C) Startup -40° – 176° F (-40° – 80° C) Storage
	Humidity	0 – 95%, non-condensing
	Fixture Run Lengths	To calculate fixture run lengths and total power consumption for your specific installation, download the Configuration Calculator from www.philipscolorkinetics.com/support/install_tool/
Certification and Safety	Certification	UL / cUL, FCC Class B, CE, PSE, CCC, SAA, C-Tick
	Environment	Dry / Damp Location, IP20

* Color temperatures conform to nominal CCTs as defined in ANSI Chromaticity Standard C78.377A.



† Lumen measurement complies with IES LM-79-08 testing procedures.

‡ L70 = 70% lumen maintenance (when light output drops below 70% of initial output).
L50 = 50% lumen maintenance (when light output drops below 50% of initial output).

Ambient luminaire temperatures specified. Lumen maintenance calculations are based on lifetime prediction graphs supplied by LED source manufacturers. Calculations for white-light LED fixtures are based on measurements that comply with IES LM-80-08 testing procedures. Refer to www.philipscolorkinetics.com/support/appnotes/lm-80-08.pdf for more information.

CHROMACORE CKTECHNOLOGY | **O P T I B I N** CKTECHNOLOGY | **POWERCORE** CKTECHNOLOGY

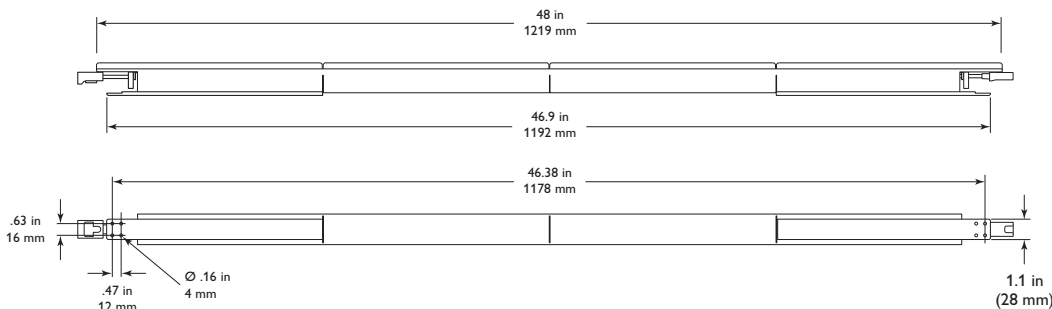

Wide beam angle

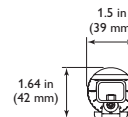

Medium beam angle

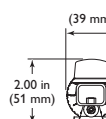

Fixtures and Accessories

iW Cove MX Powercore fixtures are part of a complete system which includes fixtures and:

- One or more Data Enabler Pro devices.
- One Leader Cable to connect each Data Enabler Pro output to a series of fixtures, or one Wiring Compartment with a sufficient length of 4-conductor copper wire. Standard 12 AWG stranded wire is recommended..
- Any Philips controller, including Light System Manager, iPlayer 3, and ColorDial Pro, or a third-party controller.

Included in the box

iW Cove MX Powercore fixture
Installation Instructions

Item	Type		Item Number	Philips 12NC
iW Cove MX Powercore 1 ft (305 mm)	110° x 110°	UL / cUL / CE	523-000002-02	910503701230
		CCC	523-000002-04	910503701232
	50 x 70 °	UL / cUL / CE	523-000002-03	910503701231
		CCC	523-000002-05	910503701992
iW Cove MX Powercore 4 ft (1.2 m)	110° x 110°	UL / cUL / CE	523-000002-06	910503702608
		CCC	523-000002-08	910503703169
	50 x 70 °	UL / cUL / CE	523-000002-07	910503702609
		CCC	523-000002-09	910503703170
Mounting Track, White	1 @ 4 ft (1219 mm)		120-000124-00	910503701787
Leader Cable with terminator	10 ft (3.1 m)	UL / cUL	108-000050-00	910503701686
		CE / CCC	108-000050-01	910503701687
Jumper Cable	1 ft (305 mm)	UL / cUL	108-000049-01	910503701683
		CE / CCC	108-000049-03	910503701685
	5 ft (1.5 m)	UL / cUL	108-000049-00	910503701682
		CE / CCC	108-000049-02	910503701684
Wiring Compartment with Terminator			120-000077-02	910503701740
Terminator, Quantity 10			120-000099-01	910503704251
Data Enabler Pro	3/4 in / 1/2 in NPT (U.S. trade size conduit)		106-000004-00	910503701210
	PG21 / PG13 (metric size conduit)		106-000004-01	910503701211

Use Item Number when ordering in North America.

Installation

iW Cove MX Powercore offers high-intensity indoor cove lighting with Powercore technology. Powercore, which integrates LED power and data management within the fixture, eases installation by eliminating the need for external power supplies.

Owner / User Responsibilities

It is the responsibility of the contractor, installer, purchaser, owner, and user to install, maintain, and operate iW Cove MX Powercore fixtures in such a manner as to comply with all applicable codes, state and local laws, ordinances, and regulations. Consult with the appropriate electrical inspector to ensure compliance.

✳ Refer to the iW Cove MX Powercore Installation Instructions for specific warning and caution statements.

Create a Lighting Design Plan and Layout Grid

✳ Refer to the Data Enabler Pro Installation Instructions or Product Guide for guidelines on configuring and positioning the Data Enabler Pro in relation to the controller.

Distance between fixtures joined end-to-end

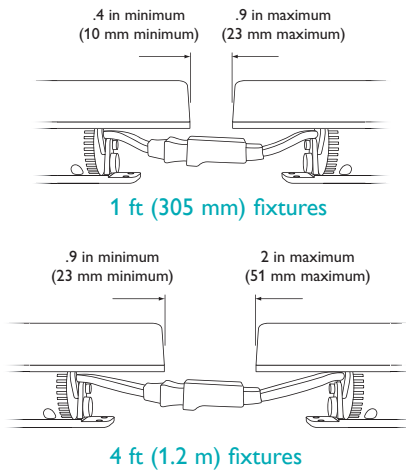

1. Determine the appropriate location of each Data Enabler Pro in relation to the fixtures, and of the fixtures in relation to each other. The Data Enabler Pro and first fixture must be separated by no more than the 10 ft (3.1 m) length of the Leader Cable.

iW Cove MX Powercore fixtures are installed in series. The in-line connectors allow end-to-end fixture connections for the best visual effects. Joined directly together, the connectors on the 1 ft (305 mm) fixtures allow for spacing of .4 in (10 mm) to .9 in (23 mm) without a jumper cable, while the connectors on the 4 ft (1.2 m) fixtures allow for spacing of .9 in (23 mm) to 2 in (51 mm) without a jumper cable. When you need to separate fixtures by more than these minimums, use the 1 ft (305 mm) or 5 ft (1.5 m) jumper cables.

The maximum number of fixtures each Data Enabler Pro can support depends on specific configuration details such as fixture length, fixture spacing, circuit size, line voltage, and Leader Cable length. For help calculating the number of fixtures your specific installation can support, download the Configuration Calculator from www.philipscolorkinetics.com/support/install_tool/, or consult Application Engineering Services at support@colorkinetics.com.

In addition to maximum fixture run lengths determined by the electrical configuration, each Data Enabler Pro imposes maximum run lengths based on data integrity. To ensure data integrity, maximum individual run lengths should not exceed 175 ft (53.3 m), and the total cable length per Data Enabler Pro should not exceed 400 ft (122 m).

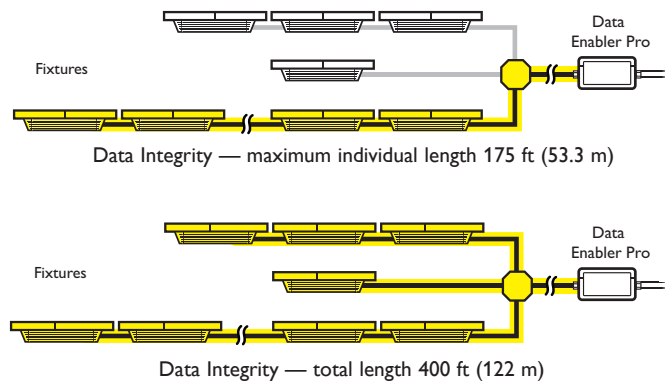

- Using the fixture's power consumption and efficiency ratings, the lighting designer or architect should calculate the cove dimensions to ensure that operating temperatures remain within safe levels. The designer or architect should also determine the cove's fascia design and fixture setback based on the cove dimensions and room width. For consistent results, the cove width and height should accommodate the fixtures' minimum mixing distances. We strongly recommend creating dimensional models and mockups prior to installation.

With all channels full on, iW Cove MX Powercore fixtures should be set back horizontally from illuminated surfaces by the minimum distances indicated in the diagrams below. Mixing distances can vary when individual warm, neutral, or cool channels only are on. For instance, for medium beam angle fixtures with the 2700 K channel only on, the minimum fixture standoff increases to 10 in (254 mm), and the minimum cove height increases to 20 in (508 mm).

iW Cove MX Powercore
110° x 110° beam angle, all on



⚙️ These diagrams provide general guidelines for positioning iW Cove MX Powercore fixtures in coves with matte white surfaces. Specific dimensions and positioning depend on the details of your installation.

⚙️ Minimum cove height is mixing distance + height of fixture to LED board.

iW Cove MX Powercore
50° x 70° beam angle, all on



Start the Installation

- Install all Data Enabler Pro devices, including any interfaces with controllers.
One Leader Cable is required to connect each run or series of fixtures to a Data Enabler Pro. The Data Enabler Pro sends power and control signals to the fixtures over the Leader Cable.
- Verify that all additional supporting equipment (switches, controllers) is in place.
- If your installation calls for Jumper Cables to add space between fixtures, make sure they are available.
- Ensure that all additional parts (optional mounting tracks, mounting hardware, terminators) and tools are available.

Unpack and Prepare Fixtures

- Carefully inspect the box containing iW Cove MX Powercore and the contents for any damage that may have occurred in transit.
- On an architectural diagram or other diagram that shows the physical layout of the installation, identify the locations of all switches, controllers, power supplies, fixtures, and Leader and Jumper Cables.

- iW Cove MX Powercore fixtures are addressable in 1 ft (305 mm) segments. This feature allows playback controllers to send unique light output data to each segment of each fixture within your installation.

Each fixture segment (node) comes pre-programmed with a unique serial number. Fixtures have one or four serial numbers depending on fixture length. As you unpack the fixtures, record the serial numbers in a layout grid (typically a spreadsheet or list) for easy reference and light addressing.

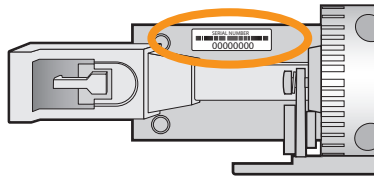

Location of serial number on 1 ft (305 mm) iW Cove MX Powercore fixtures

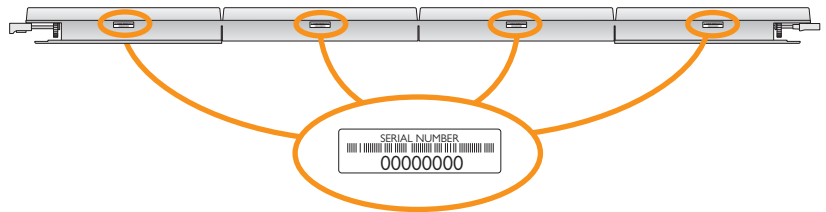

Location of serial numbers on 4 ft (1.2 m) iW Cove MX Powercore fixtures

- Assign each fixture to a position in the lighting design plan.
- To streamline installation and aid in light show programming, you can affix a weatherproof label identifying the order or placement in the installation to an inconspicuous location on each fixture's housing.

Install the Fixtures

You can mount iW Cove MX Powercore fixtures directly to a wall, ceiling, cabinet, or other secure surface. For linear applications, you can install several iW Cove MX Powercore fixtures in optional 4 ft (1.2 m) lengths of mounting track to ensure straight runs.

(Optional) Install Mounting Tracks

- Field-cut the mounting tracks to the desired length with hacksaws or tin snips.
- Install the mounting tracks using hardware suitable for the mounting surface.

To ensure proper fixture fit, hardware must not extend above the track standoffs after installation. The recommended maximum spacing between screws is 12 in (305 mm).

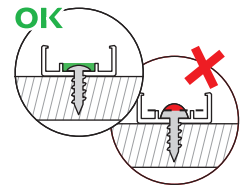

Mount and Connect the Fixtures

Make sure the power is OFF before mounting and connecting fixtures.

- Rotate an iW Cove MX Powercore fixture as necessary to provide unobstructed access to the mounting holes.
- Position the first fixture in a series.

If using mounting tracks on a horizontal surface, snap the fixture into the track.

If using mounting tracks on vertical or overhead surfaces, or if not using mounting tracks, attach the fixture with four #6 (3.5 mm) mounting screws (not included) suitable for the mounting surface.

Ensure that the male connector is in position to receive data and power from the leader cable's female connector.

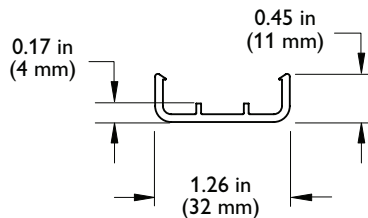

* If using the Wiring Compartment to run conduit from Data Enabler Pro to the first fixture in a run, make sure you leave enough space at the end of the run to accommodate the Wiring Compartment.

* You can use the fixture base as a template when pre-drilled holes are required. Hold the fixture in place and mark the four screw holes.

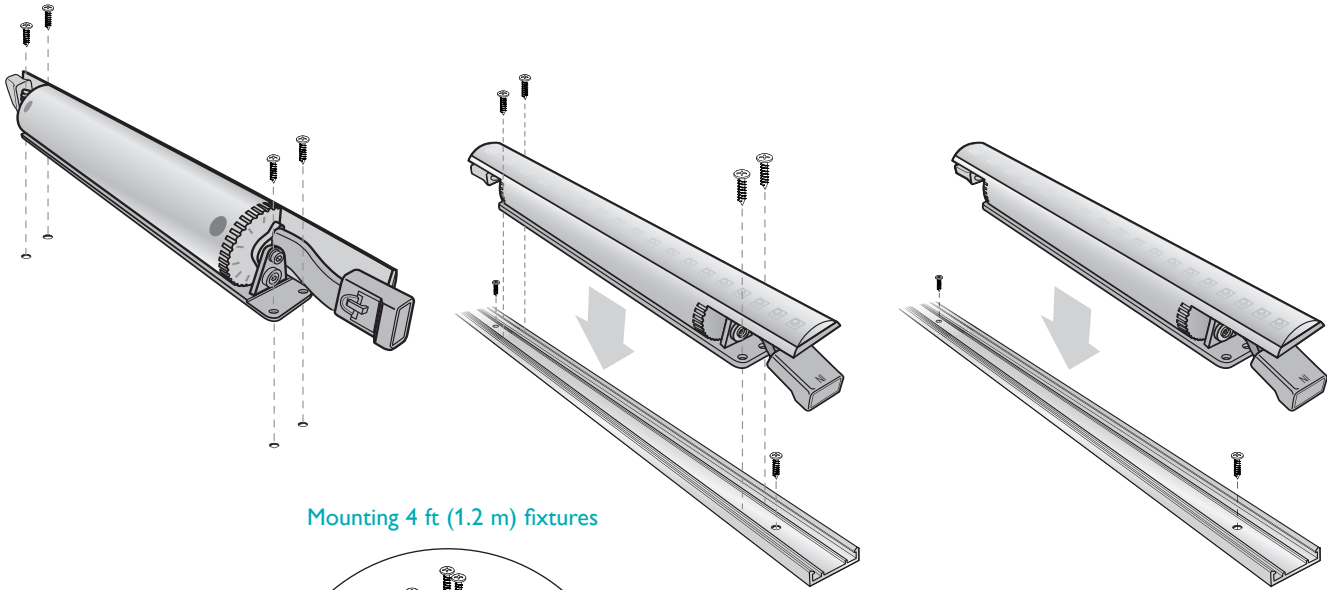

Mounting 4 ft (1.2 m) fixtures

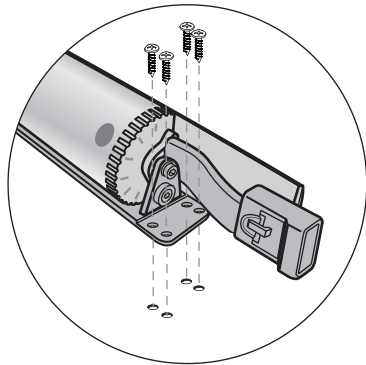

3. Position the next fixture in the series, matching the male connector end to the female connector of the previously mounted fixture. Attach the fixture to the surface or snap it into the track.
4. Continue mounting the fixtures, making power / data connections as you go, until all lights in the series are mounted.
5. Insert the provided terminator into the last fixture in the series.

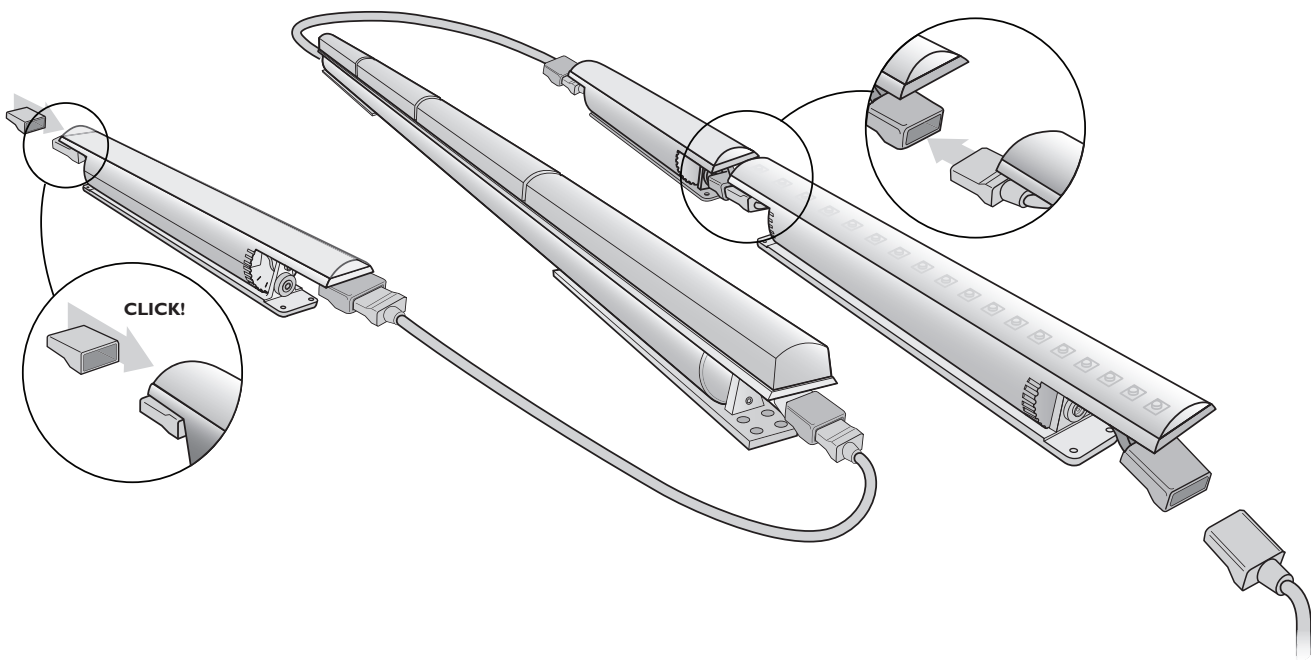

6. Make power connections:

- If using a Leader Cable, connect the Leader Cable to the first fixture in the series. Run the Leader Cable to the Data Enabler Pro, and secure connections within the Data Enabler Pro housing.

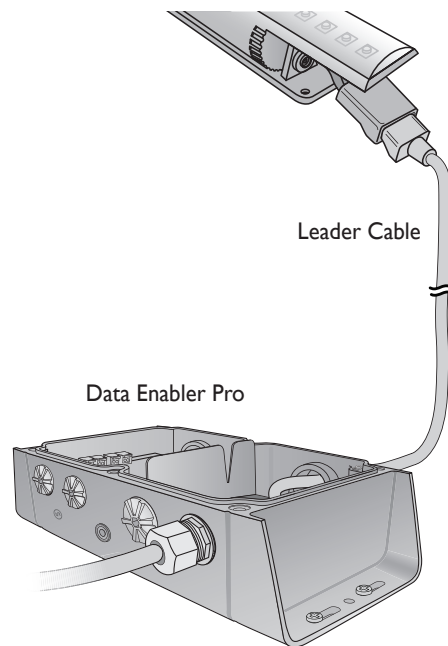

- If using the iW Cove MX Powercore Wiring Compartment to run conduit from the Data Enabler Pro to the first fixture in a series, pull cable through conduit. (We recommend standard 4-conductor 12 AWG copper wire.)

Remove the cover from the Wiring Compartment Using wire nuts, make wire connections inside the Wiring Compartment housing, then replace the cover. Connect the Wiring Compartment to the first fixture in the series.

Wiring Compartment dimensions

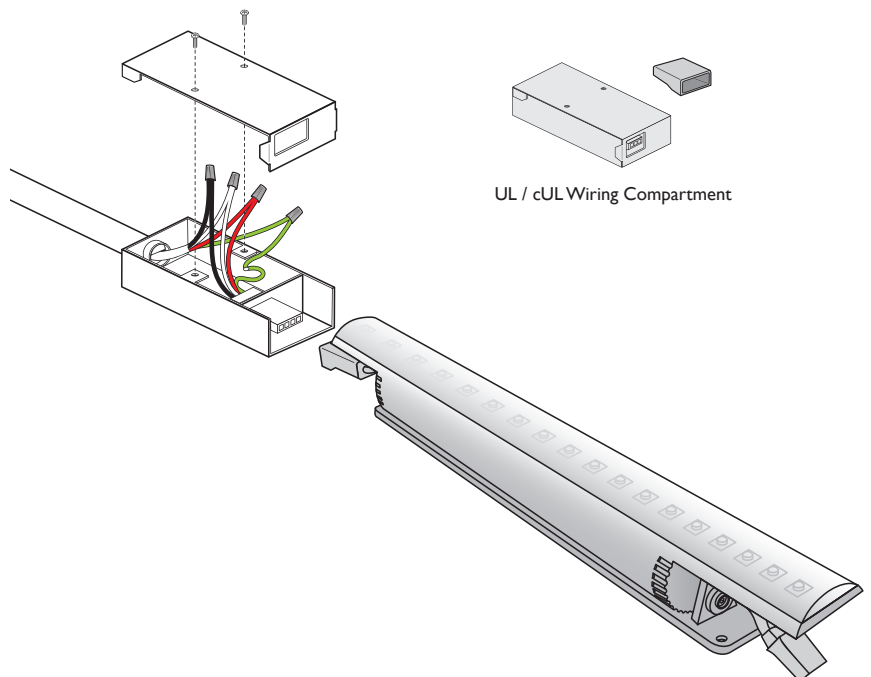
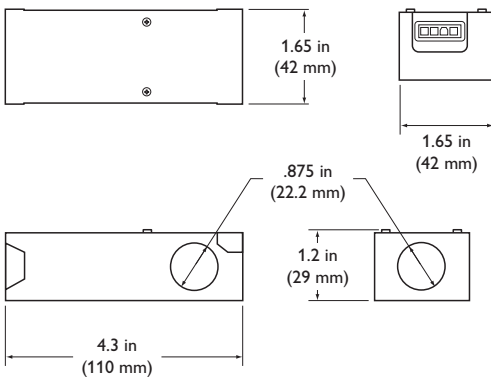

7. Secure connections within the Data Enabler Pro housing.

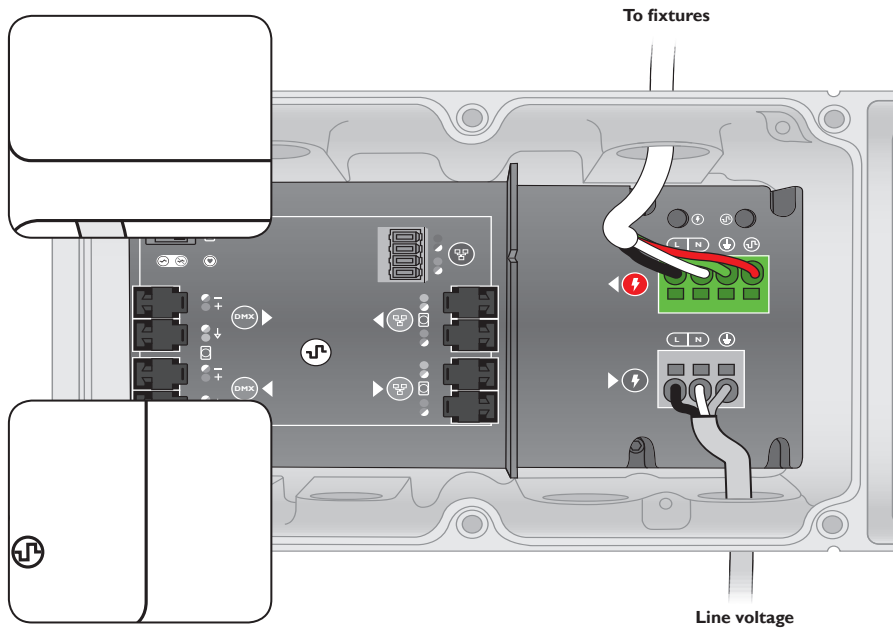

8. Repeat steps 1 – 6 for each Data Enabler Pro in the installation.

Controlling iW Cove MX Powercore Fixtures

Philips Color Kinetics offers a number of control options for all iW Cove MX Powercore fixtures, from simple to complex.

iW Cove MX Powercore fixtures are addressable in 1 ft (305 mm) segments, or nodes. iW Cove MX Powercore fixtures have one or four nodes, depending on fixture length. Each node is identified by a unique serial number.

Displaying Fixed Light Output

For installations in which you want to manually adjust the brightness and color temperature of all fixtures in unison, use ColorDial Pro or iColor Keypad. With these controllers, no fixture node addressing or configuration is necessary.

ColorDial Pro and iColor Keypad are a Power-Over-Ethernet (PoE) devices that require a PoE switch, or a conventional Ethernet switch with a PoE injector. Refer to the ColorDial Pro or iColor Keypad documentation for details on how to install and use these controllers with iW Cove MX Powercore fixtures.

iW Cove MX Powercore has three LED channels, warm, neutral, and cool. By default, iW Cove MX Powercore is set to two-channel mode. In two-channel mode, fixtures automatically map two channels of data input to the three LED channels. Using QuickPlay Pro addressing and configuration software, you can also set iW Cove MX Powercore to operate in three-channel mode.

- In three-channel mode, use the Fixed Color effect in iColor Player or iColor Keypad, or the Fixed Color or Variable Color effect in ColorDial Pro.
- In two-channel mode, use the Fixed White effect in iColor Player, iColor Keypad, or ColorDial Pro.

 You set iW Cove MX Powercore fixtures to two-channel or three-channel mode using QuickPlay Pro addressing and configuration software. You can download QuickPlay Pro from www.philipscolorkinetics.com/support/addressing.

Displaying Dynamic Light Output

For dynamic installations in which you want to display different light output on iW Cove MX Powercore fixture nodes simultaneously, you must use an RGB-based DMX or Ethernet controller such as iColor Player, iPlayer 3, or Light System Manager. To support dynamic effects that automatically modify brightness and color temperature on individual fixtures nodes you must address and configure iW Cove MX Powercore as you would any color-changing (RGB) fixture.

iW Cove MX Powercore fixtures use DMX addresses to communicate with controllers. The number of DMX addresses each iW Cove MX Powercore fixture requires depends on the fixture's configuration.

Addressing iW Cove MX Powercore Fixtures

Make sure the power is ON before addressing and configuring fixtures.

You address and configure iW Cove MX Powercore fixture nodes using QuickPlay Pro addressing and configuration software. Fixture nodes are identified within QuickPlay Pro by serial number, so you will need the layout grid that you created when you recorded the serial numbers of your fixture nodes during installation planning.

- In Ethernet installations, you can address and configure fixture nodes using QuickPlay Pro with a computer connected to your lighting installation's network. QuickPlay Pro can automatically discover all of your fixture nodes, controllers, and Data Enabler Pro devices for quick configuration.
- In DMX installations, you can address and configure fixture nodes using QuickPlay Pro with iPlayer 3 or SmartJack Pro. You can manually enter fixture node serial numbers, or you can import a spreadsheet listing each fixture node's serial number and starting DMX address.

iW Cove MX Powercore fixtures operate in 8-bit mode by default. You can configure fixtures to operate in 16-bit mode, which increases resolution for smoother dimming and more precise control. In 8-bit mode, fixture nodes use one DMX address per LED channel. In 16-bit mode, fixture nodes use two DMX addresses per LED channel. The first DMX address corresponds to the "coarse" data for that channel, and the second corresponds to the "fine" data. By using double the number of DMX addresses, 16-bit mode increases resolution from 256 dimming steps to 65,536 (256 x 256) dimming steps.

You can address and configure iW Cove MX Powercore fixture nodes in much the same way as you would address any RGB fixture. Addressing differs depending on whether fixtures are in two-channel mode or three-channel mode:

- In three-channel mode, the red channel corresponds to the warm LEDs, the green channel corresponds to the neutral LEDs, and the blue channel corresponds to the cool LEDs.
- In two-channel mode, the red channel corresponds to the warm LEDs, the green channel corresponds to the cool LEDs, and the blue channel is not used.

Note that although the blue DMX channel is not used, it is *assigned*, so that each iW Cove MX Powercore fixture node uses three DMX sequential addresses (or a multiple of three addresses), as in three-channel mode.

iW Cove MX Powercore fixture nodes come factory-addressed with a starting DMX address of 1. For lighting designs where fixtures work in unison, all fixture nodes can be assigned the same starting DMX address. Changes to the default starting DMX addresses are not necessary, but if nodes were previously readdressed for use in other installations, you must reset them. For light show

LED Channels

Channel Mode	RGB	iW Cove MX Powercore
Three-Channel Mode	Red	Warm
	Green	Neutral
	Blue	Cool
Two-Channel Mode	Red	Warm
	Green	Cool
	Blue	Unused

designs that show different light output on different fixture nodes simultaneously, you must assign unique DMX addresses to your nodes and sort them in a useful order.

The following table shows the DMX channel assignments per node for 8-bit and 16-bit iW Cove MX Powercore configurations, assuming a starting DMX address of 1.

DMX Channel Assignments Per Node: Two-Channel Mode

8-bit Mode	1		2		3	
	Warm		Cool		Unused	
16-Bit Mode	1	2	3	4	5	6
	Warm	Warm	Cool	Cool	Unused	Unused

DMX Channel Assignments Per Node: Three-Channel Mode

8-bit Mode	1		2		3	
	Warm		Neutral		Cool	
16-Bit Mode	1	2	3	4	5	6
	Warm	Warm	Neutral	Neutral	Cool	Cool

Aim and Lock the Fixtures

Make sure power is ON when aiming fixtures.

Aim the fixtures by rotating each fixture to the correct angle. There are detents every 10° in the bracket that hold it in position.

(Optional) Using a 2 mm hex key wrench, tighten the set screw located on each end of the fixture to lock the fixture in place.

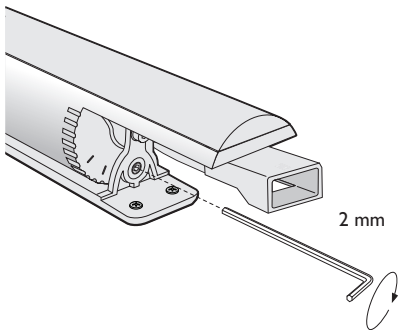

***** Do not look directly into the fixture when aiming and locking.

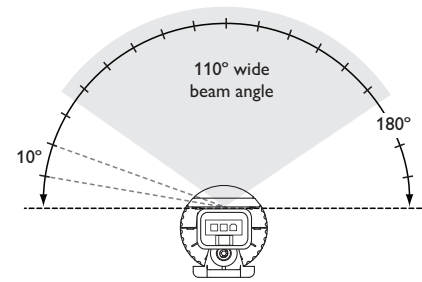

Wide beam angle (110° x 110°)

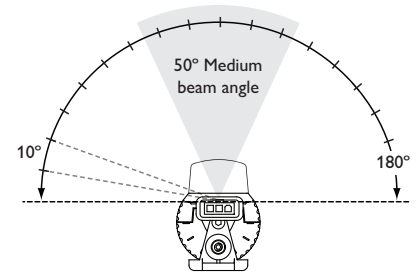

Medium beam angle (50° x 70°)

Copyright © 2015 Philips Solid-State Lighting Solutions, Inc. All rights reserved. Chromacore, Chromasic, CK, the CK logo, Color Kinetics, the Color Kinetics logo, ColorBlast, ColorBlaze, ColorBurst, ColorGraze, ColorPlay, ColorReach, iW Reach, eW Reach, DIMand, EssentialWhite, eV, iColor, iColor Cove, IntelliWhite, iW, iPlayer, Optibin, and Powercore are either registered trademarks or trademarks of Philips Solid-State Lighting Solutions, Inc. in the United States and / or other countries. All other brand or product names are trademarks or registered trademarks of their respective owners. Due to continuous improvements and innovations, specifications may change without notice.



Philips Color Kinetics
3 Burlington Woods Drive
Burlington, Massachusetts 01803 USA
Tel 888.385.5742
Tel 617.423.9999
Fax 617.423.9998
www.philipscolorkinetics.com
@colorkinetics