



Date: _____ Type: _____

Firm Name: _____

Project: _____

eW Graze EC Powercore

4000 K, 90° x 90° beam angle

Cost-effective linear exterior LED wall grazing fixture with solid white light

The most cost-effective of our solid white light grazing fixtures, eW Graze EC Powercore features a wide beam angle (90° x 90°) that produces a soft-edged, volume fill for exterior cove, niche, and architectural detail illumination. Featuring Powercore technology, fixtures process power directly from line voltage, eliminating the need for external power supplies. Fixtures are available in standard color temperatures of 2700 K, 4000 K, and 5500 K. Four fixture lengths allow flexible placement in exterior detail and cove applications both large and small.

For detailed product information, please refer to the eW Graze Powercore Family Product Guide at www.philipscolorkinetics.com/ls/essentialwhite/ewgrazeecpowercore/

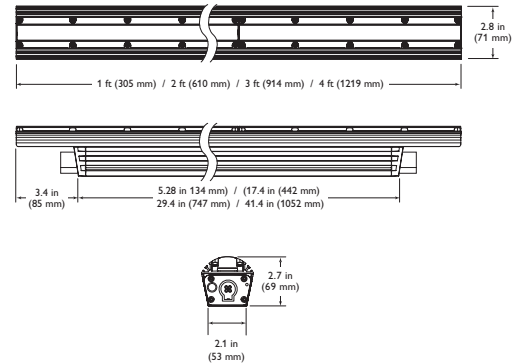

Specifications

Due to continuous improvements and innovations, specifications may change without notice.

Item	Specification	1 ft (305 mm)	2 ft (610 mm)	3 ft (914 mm)	4 ft (1219 mm)
Output	Lumens*	246	492	738	984
	Efficacy (lm / W)	45.9			
	CRI	87			
	Lumen Maintenance†	36,000 hours L70 @ 25° C	36,000 hours L70 @ 50° C	36,000 hours L50 @ 25° C	36,000 hours L50 @ 50° C
Electrical	Input Voltage	100 – 277 VAC, auto-ranging, 50 / 60 Hz			
	Power Consumption	5 W	10 W	15 W	20 W
Control	Dimming	Compatible with selected commercially available reverse-phase ELV-type dimmers‡			
Physical	Dimensions (Height x Width x Depth)	2.7 x 12 x 2.8 in (69 x 305 x 71 mm)	2.7 x 24 x 2.8 in (69 x 610 x 71 mm)	2.7 x 36 x 2.8 in (69 x 914 x 71 mm)	2.7 x 48 x 2.8 in (69 x 1219 x 71 mm)
	Weight	2.1 lb (1.0 kg)	4.6 lb (2.1 kg)	7.1 lb (3.2 kg)	9.3 lb (4.2 kg)
	Housing	Extruded anodized aluminum			
	Lens	Clear polycarbonate			
	Fixture Connectors	Integral male / female waterproof connectors			
	Mounting	Multi-positional, constant torque locking hinges			
	Temperature	-40° – 122° F (-40° – 50° C) Operating -4° – 122° F (-20° – 50° C) Startup -40° – 176° F (-40° – 80° C) Storage			
	Humidity	0 – 95%, non-condensing			
	Fixture Run Lengths	To calculate fixture run lengths and total power consumption for your specific installation, download the Configuration Calculator from www.philipscolorkinetics.com/support/install_tool/			
	Certification and Safety	Certification	UL / cUL, FCC Class A, CE, PSE, C-Tick		
Environment		Dry / Damp / Wet Location, IP66			

* 1 ft (305 mm) lumen output measurements comply with IES LM-79-08 testing procedures. 2 ft (610 mm), 3 ft (914 mm), and 4 ft (1219 mm) measurements are estimated based on the 1 ft (305 mm) measurements.

† L70 = 70% lumen maintenance (when light output drops below 70% of initial output). L50 = 50% lumen maintenance (when light output drops below 50% of initial output). Ambient luminaire temperatures specified. Lumen maintenance calculations are based on lifetime prediction graphs supplied by LED source manufacturers. Calculations for white-light LED fixtures are based on measurements that comply with IES LM-80-08 testing procedures. Refer to www.philipscolorkinetics.com/support/appnotes/lm-80-08.pdf for more information.

‡ Refer to www.philipscolorkinetics.com/support/appnotes/ for more information.



PHILIPS

Fixtures

Item	Beam Angle	2700 K		4000 K		5500 K	
		Item Number	Philips 12NC	Item Number	Philips 12NC	Item Number	Philips 12NC
eW Graze EC Powercore 1 ft (305 mm)	90° x 90°	523-000082-00	910503703154	523-000082-01	910503703808	523-000082-02	910503703809
eW Graze EC Powercore 2 ft (610 mm)	90° x 90°	523-000082-03	910503703810	523-000082-04	910503703811	523-000082-05	910503703812
eW Graze EC Powercore 3 ft (914 mm)	90° x 90°	523-000082-06	910503703813	523-000082-07	910503703814	523-000082-08	910503703815
eW Graze EC Powercore 4 ft (1219 mm)	90° x 90°	523-000082-09	910503703816	523-000082-10	910503703817	523-000082-11	910503703818

Use Item Number when ordering in North America.

Accessories

Item	Type		Item Number	Philips 12NC
Leader Cable with Terminator	UL / cUL	10 ft (3.0 m)	108-000056-03	910503704071
		50 ft (15.2 m)	108-000056-00	910503703138
	CE / PSE	10 ft (3.0 m)	108-000056-04	910503704072
		50 ft (15.2 m)	108-000056-01	910503704069
Jumper Cable	UL / cUL	End-to-End	108-000057-00	910503703139
		1 ft (305 mm)	108-000057-03	910503704076
		5 ft (1.5 m)	108-000057-06	910503704079
		10 ft (3.0 m)	108-000057-09	910503704082
	CE / PSE	End-to-End	108-000057-01	910503704074
		1 ft (305 mm)	108-000057-04	910503704077
		5 ft (1.5 m)	108-000057-07	910503704080
		10 ft (3.0 m)	108-000057-10	910503704083
Glare Shield		1 ft (305 mm)	120-000081-00	910503700745
		2 ft (610 mm)	120-000081-01	910503700746
		3 ft (914 mm)	120-000081-02	910503700747
		4 ft (1219 mm)	120-000081-03	910503700748
Additional Terminators	Quantity 10	120-000157-00	910503703142	
Additional Hinge	Quantity 1	120-000098-00	910503700772	

Use Item Number when ordering in North America.

Photometrics

eW Graze EC Powercore
4000 K, 1 ft, 90° x 90° beam angle

Polar Candela Distribution

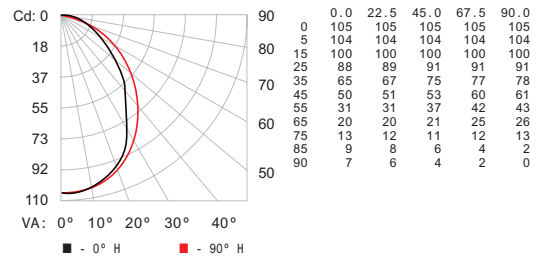

Illuminance at Distance

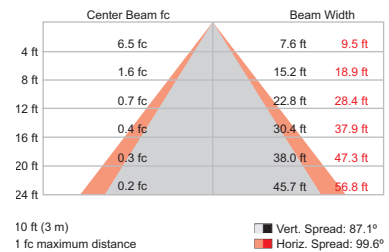

Lumens	Efficacy
246	45.9 lm / W

For lux multiply fc by 10.7

OPTIBIN[®] | POWERCORE[®] | DIMAND[®]
CK TECHNOLOGY | CK TECHNOLOGY | CK TECHNOLOGY



Philips Color Kinetics
3 Burlington Woods Drive
Burlington, Massachusetts 01803 USA
Tel 888.385.5742
Tel 617.423.9999
Fax 617.423.9998
www.philipscolorkinetics.com

Copyright © 2013 Philips Solid-State Lighting Solutions, Inc. All rights reserved.
Chromacore, Chromasic, CK, the CK logo, Color Kinetics, the Color Kinetics logo, ColorBlast, ColorBlaze, ColorBurst, eW Fuse, ColorGraze, ColorPlay, ColorReach, iW Reach, eW Reach, DIMand, EssentialWhite, eW, iColor, iColor Cove, IntelliWhite, iW, iPlayer, Optibin, and Powercore are either registered trademarks or trademarks of Philips Solid-State Lighting Solutions, Inc. in the United States and / or other countries. All other brand or product names are trademarks or registered trademarks of their respective owners. Due to continuous improvements and innovations, specifications may change without notice.

DAS-000117-62 R00 02-13