



Date: _____ Type: _____

Firm Name: _____

Project: _____

eW Cove QLX Powercore

3000 K, Wide Beam Angle

Cost-effective interior linear LED cove and accent fixture with solid white light

eW Cove QLX Powercore is a dimmable, linear LED fixture that provides an affordable, energy-efficient alternative to traditional cove lighting in applications requiring white light. With its low profile, rotating housing and flexible end-to-end locking power connectors, eW Cove QLX Powercore is the perfect choice for a wide range of interior retail, exhibit, hospitality, and architectural settings.

- Industry-best white-light quality and color consistency — Advances in Optibin, Philips proprietary binning optimization process, now provides color-consistency within a 2-step MacAdam ellipse across eW Cove product fixtures and manufacturing runs.
- Uncompromised Performance — Efficacies of near 100 lm/w provide optimum output without restrictions on lumen maintenance, operating temperature or warranty.

- Multiple options for design flexibility — Available in four color temperatures ranging from a warm 2700 K to a cool 4000 K. Lengths of 152 mm (6 in), 305 mm (12 in), and 1220 mm (48 in), wide and medium beam angles, and two power levels offer further design flexibility.
- Support for multiple voltages — Accepts power input of 120, 220 – 240, or 277 VAC for consistent installation and operation from line voltage in many locations.
- Smooth dimming capability — Patented DIMand technology offers smooth dimming capability with selected reverse-phase ELV-type dimmers.

For detailed product information, please refer to the eW Cove QLX Powercore Product Guide at www.philipscolorkinetics.com/ls/essentialwhite/ewcoveqlxpc/

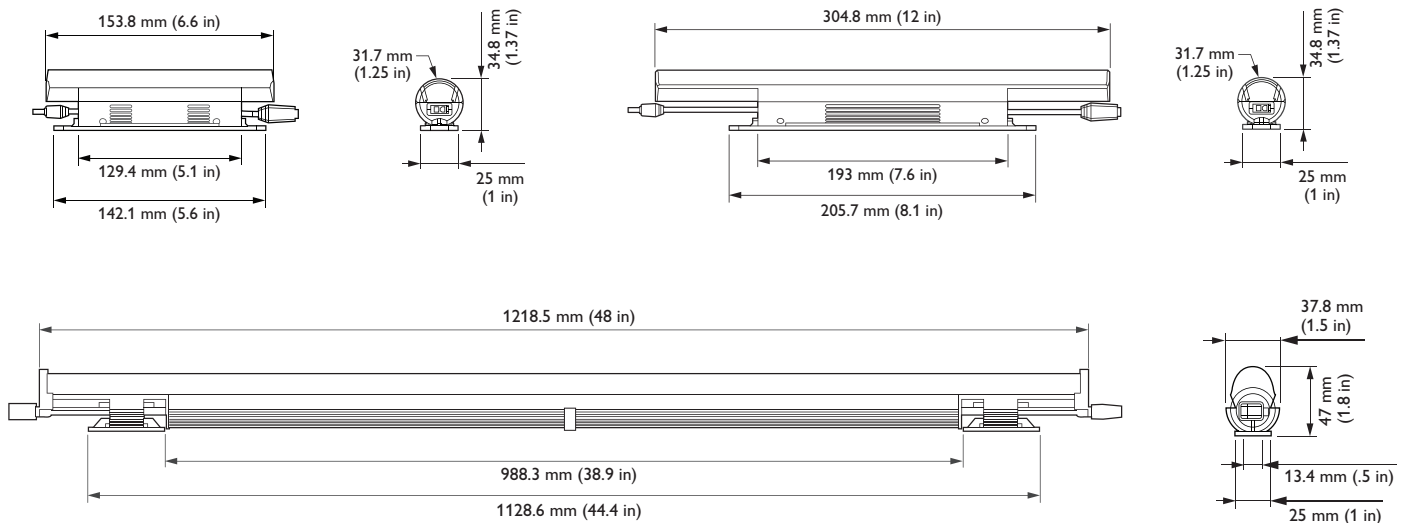

PHILIPS

Specifications - 3000 K*, Wide Beam (110° x 110°)

Due to continuous improvements and innovations, specifications may change without notice.

Item	Specification	152 mm (6 in)			305 mm (12 in)			1220 mm (48 in)			
Output	Lumens†	High Power	209			432			1575		
		Low Power	170			359			1292		
	Efficacy (lm / W)	High Power	79.2			90.3			87.9		
		Low Power	80.3			92.2			94.6		
	CRI	82			82			82			
Electrical	Input Voltage	120 VAC	240 VAC	277 VAC	120 VAC	240 VAC	277 VAC	120 VAC	240 VAC	277 VAC	
	Power Consumption	High Power	4.0 W	4.2 W	3.8 W	5.1 W	5.5 W	6.0 W	19.0 W	19.0 W	19.0 W
		Low Power	2.2 W	2.7 W	3.0 W	4.0 W	4.2 W	5.0 W	15.0 W	15.0 W	15.0 W
	Power Factor (@ 120 VAC)	.98			.99			.98			
Control	Dimming	Compatible with commercially available reverse-phase ELV-type dimmers‡									
Physical	Wide Beam Dimensions (Height x Length x Width)	35 x 152 x 32 mm (1.37 x 6 x 1.25 in)			35 x 305 x 32 mm (1.37 x 12 x 1.25 in)			47 x 1220 x 38 mm (1.90 x 48 x 1.5 in)			
	Weight (with optics)	116 g (0.25 lbs)			186 g (0.41 lbs)			910 g (2 lbs)			
	Housing	Injection-molded plastic, white finish									
	Lens	Clear Polycarbonate									
	Fixture Connections	Integral male / female connectors									
	Temperature Ranges	-20° – 50° C (-4° – 122° F) Operating -20° – 50° C (-4° – 122° F) Startup -40° – 80° C (-40° – 176° F) Storage									
	Humidity	0 – 95%, non-condensing									
Fixture Run Length	To calculate fixture run lengths and total power consumption for your specific installation, download the Configuration Calculator from www.philipscolorkinetics.com/support/install_tool/										
Certification and Safety	Certification	UL / cUL, FCC Class B, CE, SAA, C-Tick, CCC									
	Environment	Damp Location, IP20									

* Color temperatures conform to nominal CCTs as defined in ANSI Chromaticity Standard C78.377A.

† Lumen measurement complies with IES LM-79-08 testing procedures

‡ Refer to www.philipscolorkinetics.com/support/appnotes/ for specific details.



DIMAND™ | OPTIBIN™ | POWERCORE™
CK TECHNOLOGY | CK TECHNOLOGY | CK TECHNOLOGY

Lumen Maintenance

Threshold§	Ambient Temperature	Reported	Calculated
L90	@ 25°C	37,000 hrs	>47,000 hrs
	@ 50°C	17,000 hrs	>17,000 hrs
L70	@ 25°C	37,000 hrs	>175,000 hrs
	@ 50°C	37,000 hrs	>75,000 hrs

§ L_{xx} = xx% lumen maintenance (when light output drops below xx% of initial output). All values are given at B50, or the median value where 50% of the LED population is better than the reported or calculated lumen maintenance measurement.

|| Lumen maintenance figures are based on lifetime prediction graphs supplied by LED source manufacturers. Whenever possible, figures use measurements that comply with IES LM-80-08 testing procedures.

In accordance with TM-21-11, Reported values represent the interpolated value based on six times the LM-80-80 total test duration (in hours). Calculated values represent time durations that exceed six times the total test duration.

Photometrics / eW Cove QLX Powercore, 3000 K, Wide Beam Angle, 152 mm (6 in)

Photometric data is based on test results from an independent NIST traceable testing lab. IES data is available at www.philipscolorkinetics.com/support/ies.

152 mm (6 in), 110° x 110° beam angle, high power

Lumens	Efficacy
209	79.2 lm / W

Polar Candela Distribution

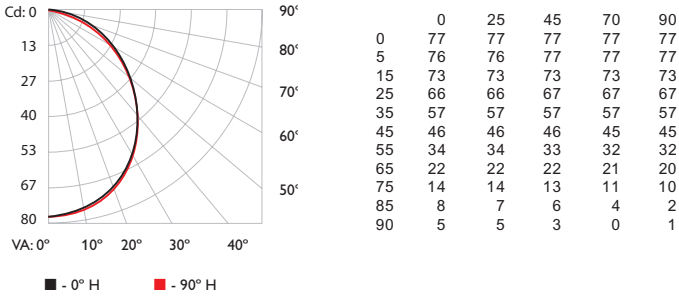

Illuminance at Distance

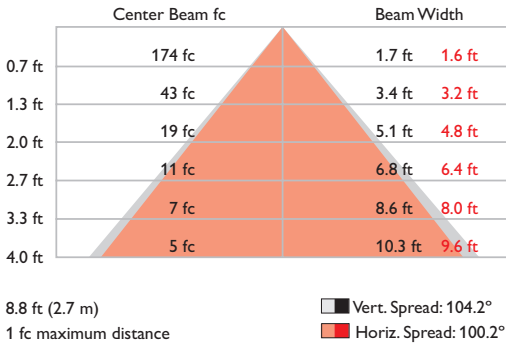

Coefficients Of Utilization - Zonal Cavity Method

RCC %:	Effective Floor Cavity Reflectance: 20%																			
	80			70			50			30			10			0				
RW %:	70	50	30	0	70	50	30	0	50	30	20	0	50	30	20	0	50	30	20	0
RCR:	0	1.18	1.18	1.18	1.15	1.15	1.15	0.98	1.10	1.10	1.10	1.05	1.05	1.05	1.00	1.00	1.00	0.98		
1	1.08	1.03	0.99	0.95	1.05	1.00	0.96	0.82	0.96	0.92	0.89	0.91	0.89	0.86	0.87	0.85	0.83	0.81		
2	0.98	0.90	0.83	0.77	0.95	0.88	0.81	0.69	0.84	0.79	0.74	0.80	0.76	0.72	0.77	0.73	0.70	0.68		
3	0.90	0.79	0.71	0.65	0.87	0.77	0.70	0.59	0.74	0.68	0.62	0.71	0.66	0.61	0.68	0.64	0.60	0.57		
4	0.82	0.70	0.62	0.55	0.80	0.69	0.61	0.51	0.66	0.59	0.53	0.63	0.57	0.52	0.61	0.56	0.51	0.49		
5	0.76	0.63	0.54	0.47	0.73	0.62	0.53	0.45	0.59	0.52	0.46	0.57	0.51	0.46	0.55	0.49	0.45	0.43		
6	0.70	0.57	0.48	0.42	0.68	0.56	0.47	0.39	0.54	0.46	0.41	0.52	0.45	0.40	0.50	0.44	0.40	0.38		
7	0.65	0.52	0.43	0.37	0.63	0.51	0.42	0.35	0.49	0.42	0.36	0.47	0.41	0.36	0.46	0.40	0.35	0.33		
8	0.61	0.47	0.39	0.33	0.59	0.46	0.38	0.32	0.45	0.38	0.32	0.43	0.37	0.32	0.42	0.36	0.32	0.30		
9	0.57	0.43	0.35	0.30	0.55	0.43	0.35	0.29	0.41	0.34	0.29	0.40	0.34	0.29	0.39	0.33	0.29	0.27		
10	0.53	0.40	0.32	0.27	0.52	0.39	0.32	0.26	0.38	0.31	0.27	0.37	0.31	0.26	0.36	0.30	0.26	0.24		

Zonal Lumen

ZONE	LUMENS	%FIXT
0- 30	58.8	28.2
0- 40	94.9	45.4
0- 60	161.0	77.0
0- 90	204.1	97.7
60- 90	43.2	20.7
70-100	23.7	11.3
90-120	4.6	2.2
90-180	4.9	2.3
0-180	209.0	100.0

For lux multiply fc by 10.7

152 mm (6 in), 110° x 110° beam angle, low power

Lumens	Efficacy
170	80.3 lm / W

Polar Candela Distribution

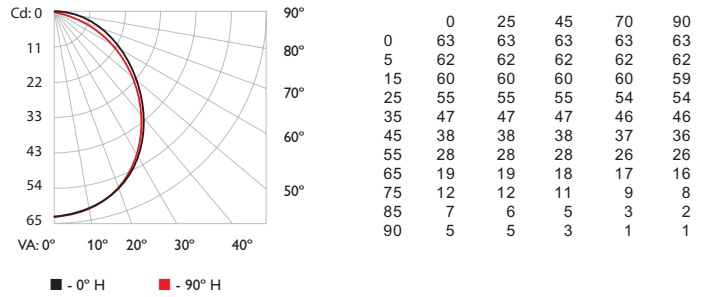

Illuminance at Distance

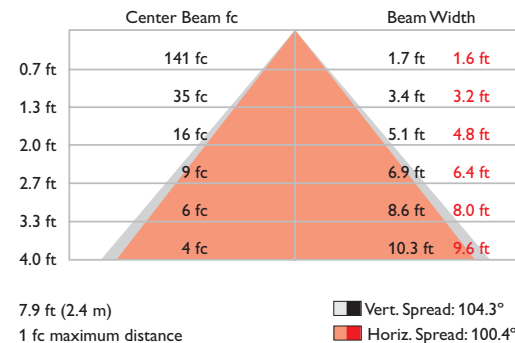

Coefficients Of Utilization - Zonal Cavity Method

RCC %:	Effective Floor Cavity Reflectance: 20%																			
	80			70			50			30			10			0				
RW %:	70	50	30	0	70	50	30	0	50	30	20	0	50	30	20	0	50	30	20	0
RCR:	0	1.19	1.19	1.19	1.15	1.15	1.15	0.98	1.10	1.10	1.10	1.05	1.05	1.05	1.00	1.00	1.00	0.98		
1	1.08	1.03	0.99	0.95	1.05	1.00	0.96	0.82	0.96	0.92	0.89	0.91	0.89	0.86	0.88	0.85	0.83	0.81		
2	0.98	0.90	0.83	0.77	0.95	0.88	0.82	0.69	0.84	0.79	0.74	0.80	0.76	0.72	0.77	0.73	0.70	0.68		
3	0.90	0.79	0.71	0.65	0.87	0.77	0.70	0.59	0.74	0.68	0.62	0.71	0.66	0.61	0.68	0.64	0.60	0.57		
4	0.82	0.70	0.62	0.55	0.80	0.69	0.61	0.51	0.66	0.59	0.53	0.63	0.57	0.52	0.61	0.56	0.51	0.49		
5	0.76	0.63	0.54	0.48	0.74	0.62	0.53	0.45	0.59	0.52	0.46	0.57	0.51	0.46	0.55	0.50	0.45	0.43		
6	0.70	0.57	0.48	0.42	0.68	0.56	0.47	0.39	0.54	0.46	0.41	0.52	0.45	0.40	0.50	0.44	0.40	0.38		
7	0.65	0.52	0.43	0.37	0.63	0.51	0.42	0.35	0.49	0.42	0.36	0.47	0.41	0.36	0.46	0.40	0.35	0.33		
8	0.61	0.47	0.39	0.33	0.59	0.46	0.38	0.32	0.45	0.38	0.32	0.43	0.37	0.32	0.42	0.36	0.32	0.30		
9	0.57	0.43	0.35	0.30	0.55	0.43	0.35	0.29	0.41	0.34	0.29	0.40	0.34	0.29	0.39	0.33	0.29	0.27		
10	0.53	0.40	0.32	0.27	0.52	0.39	0.32	0.26	0.38	0.31	0.27	0.37	0.31	0.26	0.36	0.30	0.26	0.24		

Zonal Lumen

ZONE	LUMENS	%FIXT
0- 30	47.8	28.2
0- 40	77.1	45.5
0- 60	130.7	77.1
0- 90	165.6	97.7
60- 90	34.9	20.6
70-100	19.1	11.2
90-120	3.7	2.2
90-180	3.9	2.3
0-180	169.5	100.0

For lux multiply fc by 10.7

Photometrics / eW Cove QLX Powercore, 3000 K, Wide Beam Angle, 305 mm (12 in)

Photometric data is based on test results from an independent NIST traceable testing lab. IES data is available at www.philipscolorkinetics.com/support/ies.

305 mm (12 in), 110° x 110° beam angle, high power

Lumens	Efficacy
432	90.3 lm / W

Polar Candela Distribution

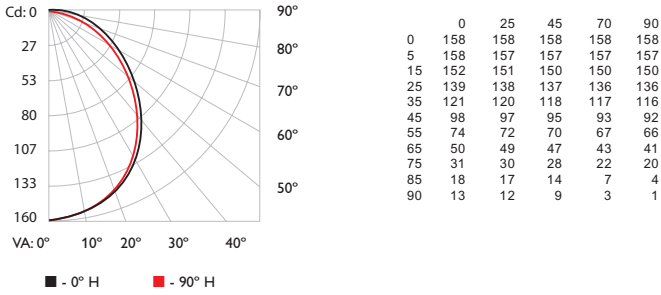

Illuminance at Distance

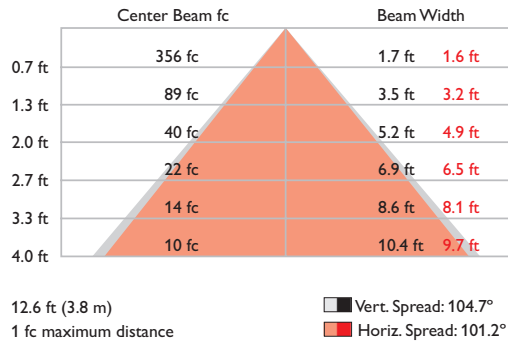

Coefficients Of Utilization - Zonal Cavity Method

RCC %:	Effective Floor Cavity Reflectance: 20%																				
	80				70				50				30				10				0
	70	50	30	0	70	50	30	0	50	30	20	50	30	20	50	30	20	0			
RCR:	0	1.19	1.19	1.19	1.16	1.16	1.16	0.98	1.10	1.10	1.10	1.05	1.05	1.05	1.00	1.00	1.00	0.98			
1	1.08	1.03	0.99	0.95	1.05	1.00	0.96	0.82	0.96	0.92	0.89	0.91	0.89	0.86	0.88	0.85	0.83	0.81			
2	0.98	0.90	0.83	0.77	0.95	0.88	0.81	0.69	0.84	0.79	0.74	0.80	0.76	0.72	0.77	0.73	0.70	0.68			
3	0.90	0.79	0.71	0.64	0.87	0.77	0.70	0.59	0.74	0.68	0.62	0.71	0.66	0.61	0.68	0.64	0.60	0.57			
4	0.82	0.70	0.62	0.55	0.80	0.69	0.61	0.51	0.66	0.59	0.53	0.63	0.57	0.52	0.61	0.56	0.51	0.49			
5	0.76	0.63	0.54	0.47	0.73	0.62	0.53	0.45	0.59	0.52	0.46	0.57	0.51	0.46	0.55	0.49	0.45	0.43			
6	0.70	0.57	0.48	0.41	0.68	0.56	0.47	0.39	0.54	0.46	0.41	0.52	0.45	0.40	0.50	0.44	0.40	0.38			
7	0.65	0.52	0.43	0.37	0.63	0.51	0.42	0.35	0.49	0.41	0.36	0.47	0.41	0.36	0.46	0.40	0.35	0.33			
8	0.61	0.47	0.39	0.33	0.59	0.46	0.38	0.32	0.45	0.38	0.32	0.43	0.37	0.32	0.42	0.36	0.32	0.30			
9	0.57	0.43	0.35	0.30	0.55	0.43	0.35	0.29	0.41	0.34	0.29	0.40	0.34	0.29	0.39	0.33	0.29	0.27			
10	0.53	0.40	0.32	0.27	0.52	0.39	0.32	0.26	0.38	0.31	0.27	0.37	0.31	0.26	0.36	0.30	0.26	0.24			

Zonal Lumen

ZONE	LUMENS	%FIXT
0- 30	120.9	28.0
0- 40	195.2	45.3
0- 60	332.3	77.0
0- 90	422.0	97.8
60- 90	89.6	20.8
70-100	49.0	11.4
90-120	9.0	2.1
90-180	9.5	2.2
0-180	431.5	100.0

For lux multiply fc by 10.7

305 mm (12 in), 110° x 110° beam angle, low power

Lumens	Efficacy
359	92.2 lm / W

Polar Candela Distribution

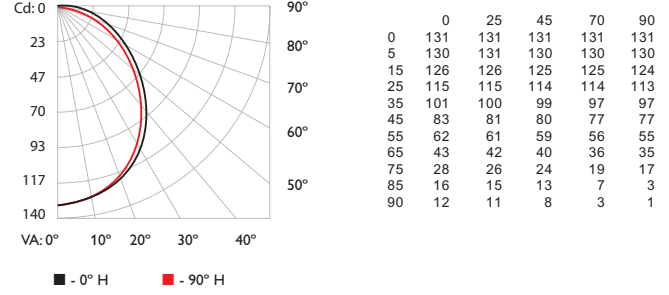

Illuminance at Distance

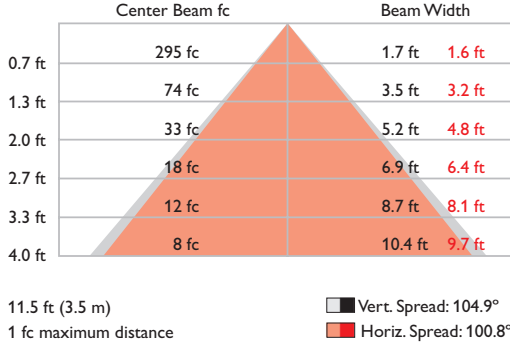

Coefficients Of Utilization - Zonal Cavity Method

RCC %:	Effective Floor Cavity Reflectance: 20%																				
	80				70				50				30				10				0
	70	50	30	0	70	50	30	0	50	30	20	50	30	20	50	30	20	0			
RCR:	0	1.18	1.18	1.18	1.15	1.15	1.15	0.98	1.10	1.10	1.10	1.05	1.05	1.05	1.00	1.00	1.00	0.98			
1	1.08	1.03	0.98	0.94	1.05	1.00	0.96	0.82	0.96	0.92	0.89	0.91	0.89	0.86	0.87	0.85	0.83	0.81			
2	0.98	0.90	0.83	0.77	0.95	0.88	0.81	0.69	0.84	0.78	0.74	0.80	0.76	0.72	0.77	0.73	0.70	0.67			
3	0.90	0.79	0.71	0.64	0.87	0.77	0.70	0.59	0.74	0.67	0.62	0.71	0.65	0.61	0.68	0.63	0.59	0.57			
4	0.82	0.70	0.62	0.55	0.80	0.69	0.60	0.51	0.66	0.59	0.53	0.63	0.57	0.52	0.61	0.56	0.51	0.49			
5	0.76	0.63	0.54	0.47	0.73	0.62	0.53	0.44	0.59	0.52	0.46	0.57	0.50	0.45	0.55	0.49	0.45	0.43			
6	0.70	0.57	0.48	0.41	0.68	0.56	0.47	0.39	0.54	0.46	0.41	0.52	0.45	0.40	0.50	0.44	0.39	0.37			
7	0.65	0.51	0.43	0.37	0.63	0.51	0.42	0.35	0.49	0.41	0.36	0.47	0.40	0.36	0.46	0.40	0.35	0.33			
8	0.60	0.47	0.39	0.33	0.59	0.46	0.38	0.31	0.45	0.37	0.32	0.43	0.37	0.32	0.42	0.36	0.32	0.30			
9	0.57	0.43	0.35	0.30	0.55	0.43	0.35	0.28	0.41	0.34	0.29	0.40	0.33	0.29	0.39	0.33	0.29	0.27			
10	0.53	0.40	0.32	0.27	0.52	0.39	0.32	0.26	0.38	0.31	0.26	0.37	0.31	0.26	0.36	0.30	0.26	0.24			

Zonal Lumen

ZONE	LUMENS	%FIXT
0- 30	100.0	27.9
0- 40	161.5	45.0
0- 60	274.7	76.6
0- 90	350.2	97.7
60- 90	75.5	21.1
70-100	41.8	11.7
90-120	7.8	2.2
90-180	8.3	2.3
0-180	358.5	100.0

For lux multiply fc by 10.7

Photometrics / eW Cove QLX Powercore, 3000 K, Wide Beam Angle, 1220 mm (48 in)

Photometric data is based on test results from an independent NIST traceable testing lab. IES data is available at www.philipscolorkinetics.com/support/ies.

1220 mm (48 in), 110° x 110° beam angle, high power

Lumens	Efficacy
1575	87.9 lm / W

Polar Candela Distribution

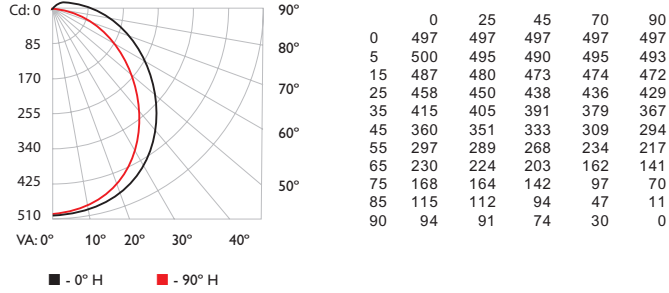

Illuminance at Distance

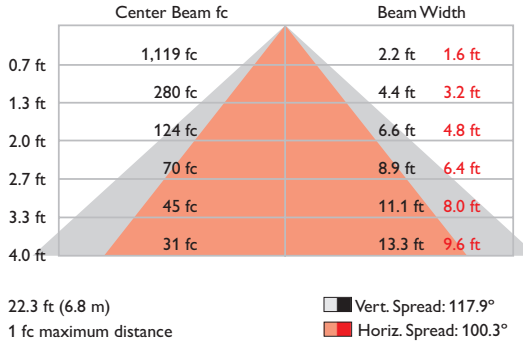

Coefficients Of Utilization - Zonal Cavity Method

RCC %:	80	70	50	30	0	Effective Floor Cavity Reflectance: 20%												
RW %:	70	50	30	0	70	50	30	0	50	30	20	50	30	20	50	30	20	0
0	1.17	1.17	1.17	1.17	1.14	1.14	1.14	0.93	1.07	1.07	1.07	1.01	1.01	1.01	0.96	0.96	0.96	0.93
1	1.06	1.00	0.96	0.91	1.02	0.97	0.93	0.76	0.92	0.88	0.85	0.87	0.84	0.81	0.82	0.80	0.78	0.75
2	0.96	0.87	0.80	0.73	0.92	0.84	0.78	0.63	0.80	0.74	0.69	0.75	0.71	0.67	0.71	0.68	0.64	0.62
3	0.87	0.76	0.68	0.61	0.84	0.74	0.66	0.53	0.70	0.63	0.58	0.66	0.61	0.56	0.63	0.58	0.54	0.52
4	0.80	0.67	0.58	0.51	0.77	0.65	0.57	0.46	0.62	0.55	0.49	0.59	0.53	0.48	0.56	0.51	0.46	0.44
5	0.73	0.60	0.51	0.44	0.71	0.59	0.50	0.40	0.56	0.48	0.42	0.53	0.46	0.41	0.50	0.45	0.40	0.38
6	0.68	0.54	0.45	0.38	0.65	0.53	0.44	0.35	0.50	0.43	0.37	0.48	0.41	0.36	0.46	0.40	0.35	0.33
7	0.63	0.49	0.40	0.34	0.61	0.48	0.39	0.31	0.46	0.38	0.33	0.44	0.37	0.32	0.42	0.36	0.31	0.29
8	0.58	0.45	0.36	0.30	0.56	0.44	0.36	0.28	0.42	0.34	0.29	0.40	0.33	0.29	0.38	0.33	0.28	0.26
9	0.54	0.41	0.33	0.27	0.53	0.40	0.32	0.25	0.38	0.31	0.26	0.37	0.30	0.26	0.35	0.30	0.25	0.24
10	0.51	0.38	0.30	0.25	0.49	0.37	0.29	0.23	0.36	0.29	0.24	0.34	0.28	0.24	0.33	0.27	0.23	0.21

Zonal Lumen

ZONE	LUMENS	%FIXT
0- 30	381.7	24.2
0- 40	620.4	39.4
0- 60	1,086.7	69.0
0- 90	1,470.4	93.3
60- 90	383.7	24.4
70-100	251.6	16.0
90-120	89.5	5.7
90-180	104.8	6.7
0-180	1,575.2	100.0

For lux multiply fc by 10.7

1220 mm (48 in), 110° x 110° beam angle, low power

Lumens	Efficacy
1292	94.6 lm / W

Polar Candela Distribution

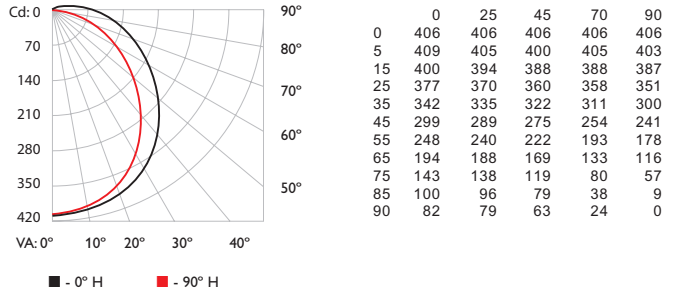

Illuminance at Distance

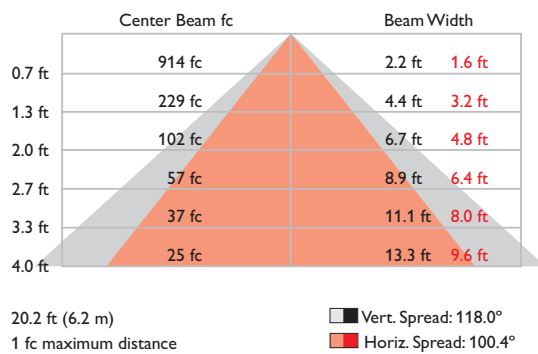

Coefficients Of Utilization - Zonal Cavity Method

RCC %:	80	70	50	30	0	Effective Floor Cavity Reflectance: 20%												
RW %:	70	50	30	0	70	50	30	0	50	30	20	50	30	20	50	30	20	0
0	1.17	1.17	1.17	1.17	1.14	1.14	1.14	0.93	1.07	1.07	1.07	1.01	1.01	1.01	0.96	0.96	0.96	0.93
1	1.06	1.00	0.95	0.91	1.02	0.97	0.93	0.76	0.92	0.88	0.85	0.87	0.84	0.81	0.82	0.80	0.77	0.75
2	0.96	0.87	0.80	0.73	0.92	0.84	0.78	0.63	0.80	0.74	0.69	0.75	0.71	0.67	0.71	0.68	0.64	0.62
3	0.87	0.76	0.67	0.61	0.84	0.74	0.66	0.53	0.70	0.63	0.58	0.66	0.61	0.56	0.63	0.58	0.54	0.51
4	0.80	0.67	0.58	0.51	0.77	0.65	0.57	0.46	0.62	0.55	0.49	0.59	0.53	0.48	0.56	0.51	0.46	0.44
5	0.73	0.60	0.51	0.44	0.71	0.59	0.50	0.40	0.56	0.48	0.42	0.53	0.46	0.41	0.50	0.45	0.40	0.38
6	0.68	0.54	0.45	0.38	0.65	0.53	0.44	0.35	0.50	0.43	0.37	0.48	0.41	0.36	0.46	0.40	0.35	0.33
7	0.63	0.49	0.40	0.34	0.61	0.48	0.39	0.31	0.46	0.38	0.33	0.44	0.37	0.32	0.42	0.36	0.31	0.29
8	0.58	0.45	0.36	0.30	0.56	0.44	0.36	0.28	0.42	0.34	0.29	0.40	0.33	0.29	0.38	0.32	0.28	0.26
9	0.54	0.41	0.33	0.27	0.53	0.40	0.32	0.25	0.38	0.31	0.26	0.37	0.30	0.26	0.35	0.30	0.25	0.23
10	0.51	0.38	0.30	0.25	0.49	0.37	0.29	0.23	0.36	0.29	0.24	0.34	0.28	0.23	0.33	0.27	0.23	0.21

Zonal Lumen

ZONE	LUMENS	%FIXT
0- 30	311.9	24.1
0- 40	507.0	39.2
0- 60	888.2	68.8
0- 90	1,203.9	93.2
60- 90	315.7	24.4
70-100	208.1	16.1
90-120	75.0	5.8
90-180	87.9	6.8
0-180	1,291.8	100.0

For lux multiply fc by 10.7

Ordering Information - 3000 K*, Wide Beam (110° x 110°)

	Power Level	152 mm (6 in)		305 mm (12 in)		1220 mm (48 in)	
		Item Number	Philips 12NC	Item Number	Philips 12NC	Item Number	Philips 12NC
eW Cove QLX Powercore 120 VAC	High	523-000090-49	910503705116	523-000091-49	910503705196	523-000092-49	910503705277
	Low	523-000090-17	910503705083	523-000091-17	910503705164	523-000092-17	910503705245
eW Cove QLX Powercore 220-240 VAC	High	523-000090-57	910503705124	523-000091-57	910503705205	523-000092-57	910503705285
	Low	523-000090-25	910503705091	523-000091-25	910503705172	523-000092-25	910503705253
eW Cove QLX Powercore 220-240 VAC <i>Fixture and 3 m (10 ft) Leader Cable with terminator</i>	High	523-000090-65	910503705132	523-000091-65	910503705213	523-000092-65	910503705293
	Low	523-000090-33	910503705099	523-000091-33	910503705180	523-000092-33	910503705261
eW Cove QLX Powercore 277 VAC	High	523-000090-73	910503705140	523-000091-73	910503705221	523-000092-73	910503705302
	Low	523-000090-41	910503705108	523-000091-41	910503705188	523-000092-41	910503705269

* Color temperatures conform to nominal CCTs as defined in ANSI Chromaticity Standard C78.377A.



Use Item Number when ordering in North America.

Compatible Dimmers†

Supplier	Part Number	Description	Voltage
Philips	913701252701	Captivation Phase Dimmer DC-DPD-I-1S-101	120 VAC
Philips	913703021009	DTE310	230 VAC
Philips	912400133633	Data Adapter; DALI to ELV, DigiDim 452	230 VAC
Philips	913701252701	Captivation Phase Dimmer DC-DPD-I-1S-101	277 VAC
Philips Strand	A21 with IGBT module	A21 Dimmer Cabinet with IGBT Dimmer Module	120 VAC
Philips Strand	A21 with IGBT module	A21 Dimmer Cabinet with IGBT Dimmer Module	277 VAC
Lutron	NTELV-600	Nova T Electronic Low Voltage Dimmer	120 VAC
Lutron	PHPM-PA-DV-WH	Phase-Adaptive Power Module	120 VAC
Lutron	PHPM-PA-DV-WH	Phase-Adaptive Power Module	277 VAC

† These dimmers have been tested in our lab and found to be compatible with this product. All installations are different. We highly recommend performing a full mockup of every lighting circuit, including all luminaires and controls, to test for the desired dimming range. Visit <http://1.usa.gov/1g3cGfs> for more information.

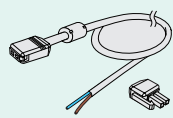
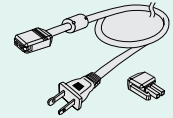
Accessories

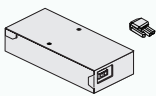
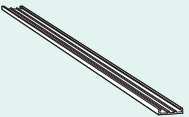
Item	Housing Color	Dimensions	Item Number	Philips 12NC		
Leader Cable (includes terminator), UL / cUL	Black	3 m (10 ft)	108-000032-10	912400130570		For connection to standard junction box
Leader Cable (includes terminator), CE / CCC	Black	3 m (10 ft)	108-000032-11	912400130571		
Leader Cable (includes terminator), UL / cUL	White	3 m (10 ft)	108-000032-12	912400130572		
Leader Cable (includes terminator), CE / CCC	White	3 m (10 ft)	108-000032-13	912400130573		
Leader Cable (includes terminator), UL, US Plug	Black	2.4 m (8 ft)	108-000032-14	912400130574		For portable installations
Jumper Cable, UL / cUL	White	305 mm (1 ft)	108-000033-06	910503700895		Depending on the installation's design, you may need jumper cables to add space between fixtures
		1.5 m (5 ft)	108-000033-07	910503700896		
Jumper Cable, CE / CCC	White	305 mm (1 ft)	108-000033-08	910503700897		
		1.5 m (5 ft)	108-000033-09	910503700898		
Wiring Compartment (includes terminator)	White	2.9 x 6.8 x 16 cm (1.17 x 2.7 x 6.32 in) (H x W x L)	120-000076-01	912400130576		Can be used for direct connection to conduit
Mounting Track	White	1219 mm (4 ft)	120-000125-00	910503701788		Optional mounting track ensures straight runs of fixtures

Use Item Number when ordering in North America.

Copyright © 2015 Philips Solid-State Lighting Solutions, Inc. All rights reserved. Chromacore, Chromasic, CK, the CK logo, Color Kinetics, the Color Kinetics logo, ColorBlast, ColorBlaze, ColorBurst, ColorGraze, ColorPlay, ColorReach, iW Reach, eW Reach, DIMand, EssentialWhite, eW, iColor, iColor Cove, IntelliWhite, iW, iPlayer, Optibin, and Powercore are either registered trademarks or trademarks of Philips Solid-State Lighting Solutions, Inc. in the United States and / or other countries. All other brand or product names are trademarks or registered trademarks of their respective owners. Due to continuous improvements and innovations, specifications may change without notice.



Philips Color Kinetics
3 Burlington Woods Drive
Burlington, Massachusetts 01803 USA
Tel 888.385.5742
Tel 617.423.9999
Fax 617.423.9998
www.philipscolorkinetics.com
[@colorkinetics](https://twitter.com/colorkinetics)