

Date: _____ Type: _____

Firm Name: _____

Project: _____

SkyRibbon

Essential White Wall Grazing Powercore, 3500 K, 10° × 90° spread lens

Recessed linear interior LED wall grazing fixture with solid white light

SkyRibbon Essential White Wall Grazing Powercore is a recessed linear interior LED wall grazing fixture offering high-quality, dimmable solid white light in four color temperatures, ranging from warm 2700 K to cool 4000 K. Brilliant light output and industry-leading color consistency make fixtures ideal for a variety of interior wall-grazing applications. Multiple housing options accommodate a number of installation methods.

- Four color temperatures — Solid white light LED modules available in 2700 K, 3000 K, 3500 K, and 4000 K color temperatures, supporting a broad selection of design objectives.
- High-quality illumination in a variety of beam angles — Native 10° × 10° beam angle. Holographic diffusion lenses offer additional 10° × 60°, 10° × 90°, 30° × 30°, and 30° × 60° beam angle options for design flexibility.
- Multiple housing options for installation and mounting flexibility — T-Bar, Slotted-T, Flanged, and Flangeless housings support numerous installation methods and appearances.
- Flexible configuration — Available in 300 mm (1 ft) and 1200 mm (4 ft) fixture lengths with multiple jumper cables, corners, terminals, and connector options to accommodate nearly any layout.
- Integrates patented Powercore technology — Powercore rapidly, efficiently, and accurately controls power output to fixtures directly from line voltage, eliminating the need for an external power supply.
- Dimming capability — Patented DIMand technology offers smooth dimming capability with selected commercially available reverse-phase ELV-type dimmers.
- Optibin advanced binning algorithm — Exceeds the recognized standards for color quality to guarantee uniformity and color consistency across LED sources, fixtures, and manufacturing runs.
- Three voltage options — Available 120 VAC, 220 – 240 VAC, and 277 VAC fixtures ensure consistent operation worldwide.

For detailed product information, please refer to SkyRibbon Essential White Wall Grazing Powercore Product Guide at www.philipscolorkinetics.com/ls/ew/skyribbon-wall-grazing/

PHILIPS

CE Dimensional Diagrams

SkyRibbon Wall Grazing Powercore Flanged Housing, 220 – 240 VAC

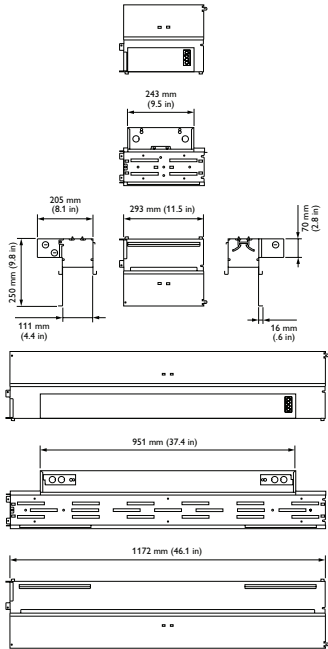

SkyRibbon Wall Grazing Powercore Flangeless Housing, 220 – 240 VAC

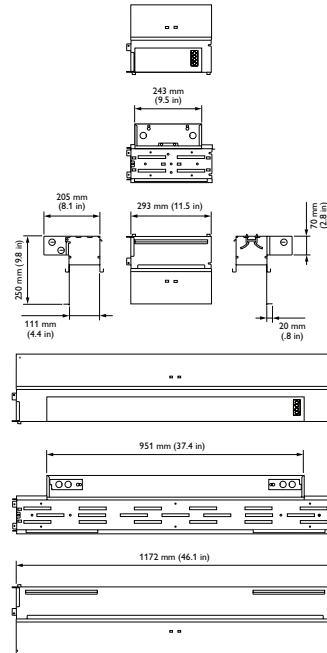

SkyRibbon Wall Grazing Powercore T-Bar / Slotted-T Housing, 220 – 240 VAC

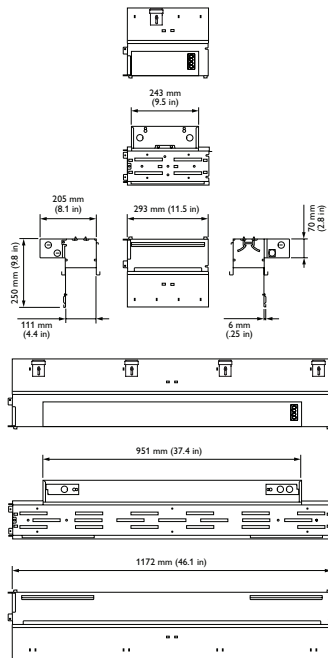

UL Dimensional Diagrams

SkyRibbon Wall Grazing Powercore Flanged Housing, 120 / 277 VAC

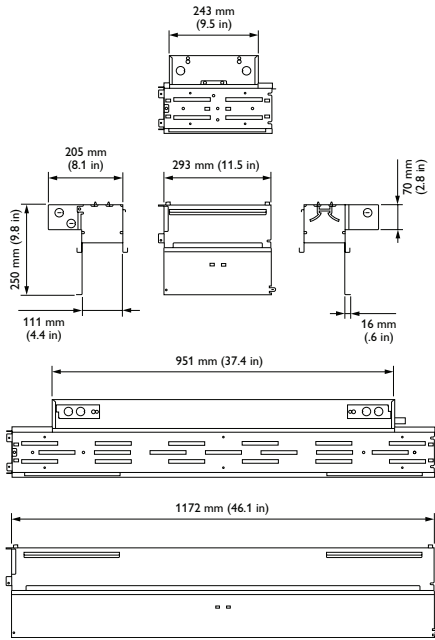

SkyRibbon Wall Grazing Powercore Flangeless Housing, 120 / 277 VAC

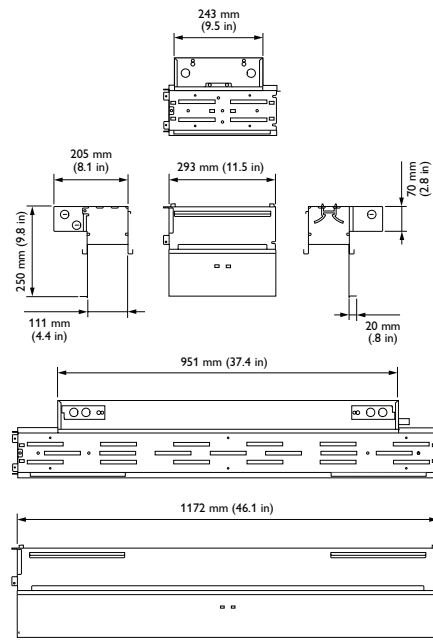

SkyRibbon Wall Grazing Powercore T-Bar / Slotted-T Housing, 120 / 277 VAC

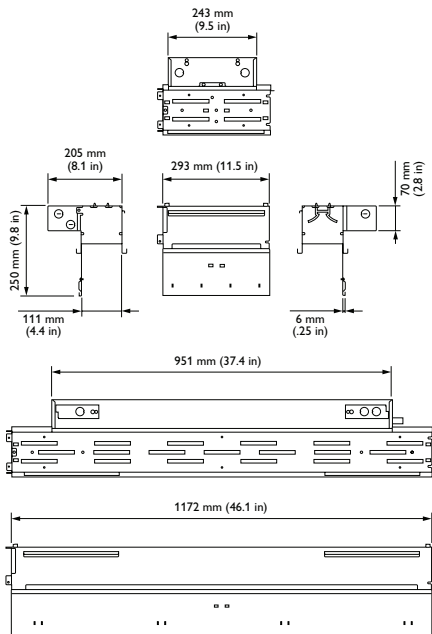

Photometrics / SkyRibbon Essential White Wall Grazing Powercore, 3500 K, 10° x 90° spread lens, .3 m (1 ft)

Photometric data is based on test results from an independent NIST traceable testing lab. IES data is available at www.philipscolorkinetics.com/support/ies.

Lumens	Efficacy
847	53.3 lm / W

Polar Candela Distribution

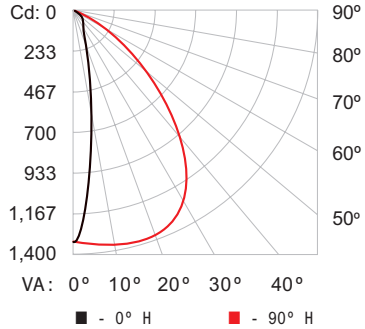

	0	25	45	70	90
0	1327	1327	1327	1327	1327
5	1015	1039	1142	1284	1341
15	221	265	442	1007	1374
25	108	114	157	605	1330
35	87	91	102	298	1103
45	64	72	84	146	703
55	47	53	67	86	293
65	35	38	48	55	88
75	25	26	30	31	30
85	19	18	15	10	4
90	18	17	14	7	1

Illuminance at Distance

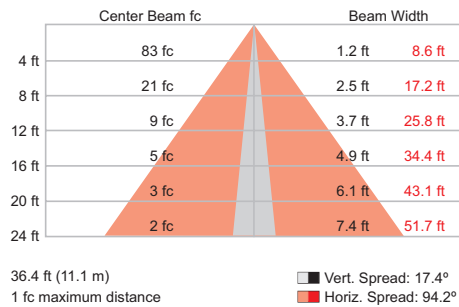

Coefficients Of Utilization - Zonal Cavity Method

Effective Floor Cavity Reflectance: 20%

RCC %:	80	70	50	30	10	0													
RW %:	70	50	30	0	70	50	30	0	50	30	20	50	30	20	0				
RCR:	0	119	119	119	119	116	116	116	98	110	110	110	105	105	105	100	100	100	98
	1	111	108	104	102	108	105	102	89	101	99	99	97	95	93	93	92	90	88
	2	104	98	93	89	102	96	91	80	92	88	85	89	86	83	86	83	81	79
	3	97	90	83	78	95	88	82	73	85	80	76	82	78	75	80	76	73	71
	4	91	82	76	70	89	81	75	66	78	73	69	76	72	68	74	70	67	65
	5	86	76	69	64	84	75	68	61	73	67	63	71	66	62	69	65	61	60
	6	81	71	64	59	79	70	63	56	68	62	58	66	61	57	65	60	57	55
	7	77	66	59	54	75	65	58	52	64	58	53	62	57	53	61	56	53	51
	8	73	62	55	50	71	61	55	49	60	54	50	58	53	49	57	53	49	47
	9	69	58	51	47	68	57	51	46	56	50	46	55	50	46	54	49	46	44
	10	66	55	48	44	64	54	48	43	53	48	44	52	47	43	51	47	43	42

Zonal Lumen

Zone	Lumens	% Fixture
0 - 60	764.2	90.2 %
60 - 90	67.9	8.0 %
0 - 90	832.1	98.3 %
90 - 180	14.7	1.7 %
0 - 180	846.8	100 %

For lux multiply fc by 10.7

Specifications / SkyRibbon Essential White Wall Grazing Powercore, 3500 K, 10° x 90° spread lens, .3 m (1 ft)

Due to continuous improvements and innovations, specifications may change without notice

Item	Specification	Details
Output	Lumens*	847
	Efficacy (lm / W)	53.3
	CRI	84
	Power Factor	.99 @ 120 VAC
	Color Temperature†	3500 K
	Lumen Maintenance‡	76,000 hours L70 @ 25° C 50,000 hours L70 @ 40° C 100,000 hours L50 @ 25° C 80,000 hours L50 @ 40° C
Electrical	Input Voltage	120 VAC, 220 – 240 VAC, 277 VAC, 50 / 60 Hz
	Power Consumption	16 W (0.3 m / 1ft 120 VAC) 60 W (1.2 m / 4ft 120 VAC) 17 W (0.3 m / 1ft 220 – 240 / 277 VAC) 60 W (1.2 m / 4ft 220 – 240 / 277 VAC)
Control	Dimming	Compatible with selected commercially available reverse-phase ELV-type dimmers§
Physical	Housing Material	Steel, white powder-coated finish
	Lens	Polycarbonate
	Fixture Connections	178 mm (7 in) flying leads, integral male / female connectors (120 / 277 VAC) Wieland integral male / female connectors (220 – 240 VAC)
	Temperature Ranges	-20° – 40° C (-4° – 104° F) Operating -20° – 40° C (-4° – 104° F) Startup -40° – 80° C (-40° – 176° F) Storage
	Fixture Run Lengths	To calculate fixture run lengths and total power consumption for your specific installation, download the Configuration Calculator from www.philipscolorkinetics.com/support/install_tool/
	Humidity	0 – 95%, non-condensing
Certification and Safety	Certification	UL / cUL, FCC Class A, CE
	Environment	Dry / Damp Location, IP20

* Lumen measurement complies with IES LM-79-08 testing procedures.

† Color temperatures conform to nominal CCTs as defined in ANSI Chromaticity Standard C78.377A.

‡ L70 = 70% lumen maintenance (when light output drops below 70% of initial output).

L50 = 50% lumen maintenance (when light output drops below 50% of initial output). Ambient luminaire temperatures specified. Lumen maintenance calculations are based on lifetime prediction graphs supplied by LED source manufacturers. Calculations for white-light LED fixtures are based on measurements that comply with IES LM-80-08 testing procedures. Refer to www.philipscolorkinetics.com/support/appnotes/lm-80-08.pdf for more information.

§ Refer to www.philipscolorkinetics.com/support/appnotes/ for specific details.





Dimensions and Weight

Fixture	Physical Characteristics	T-Bar / Slotted-T	Flanged	Flangeless
.3 m (1 ft)	Housing Dimensions <i>Height x Width x Depth</i>	251 x 293 x 205 mm (9.9 x 11.5 x 8.1 in)	251 x 293 x 205 mm (9.9 x 11.5 x 8.1 in)	251 x 293 x 205 mm (9.9 x 11.5 x 8.1 in)
	Assembled Weight†	3.3 kg (7.3 lbs)	3.3 kg (7.3 lbs)	3.3 kg (7.3 lbs)
1.2 m (4 ft)	Housing Dimensions <i>Height x Width x Depth</i>	251 x 1172 x 205 mm (9.9 x 46.1 x 8.1 in)	251 x 1172 x 205 mm (9.9 x 46.1 x 8.1 in)	251 x 1172 x 205 mm (9.9 x 46.1 x 8.1 in)
	Assembled Weight†	10.5 kg (23.1 lb)	10.5 kg (23.1 lb)	10.5 kg (23.1 lb)

† Assembled weight includes fixture housing and LED module.

Product Selection

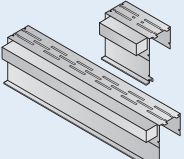
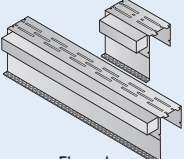
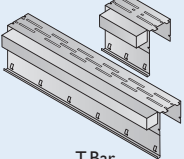
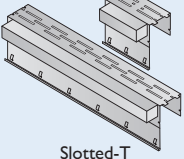
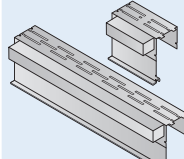
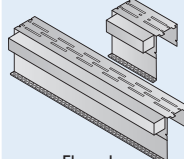
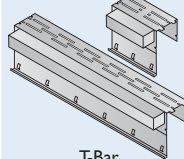
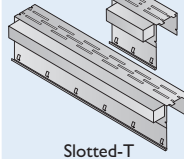
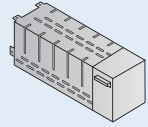
To order a complete SkyRibbon Essential White Wall Grazing Powercore fixture, choose a housing (voltage, length, and type), an LED module, a spread lens, a Leader Cable, and optional Jumper Cables and louvers.

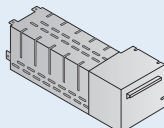
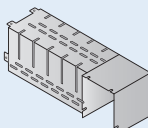
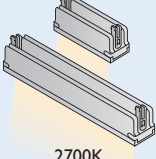
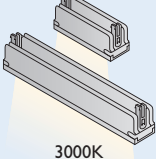
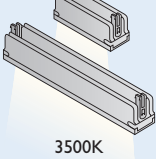
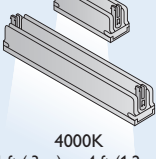
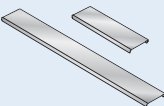
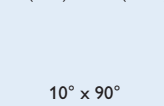
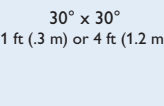
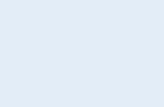
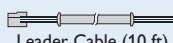
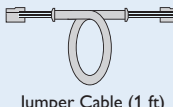
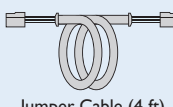
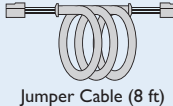
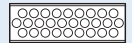
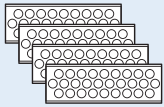
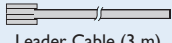
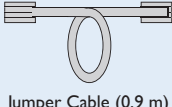
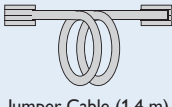
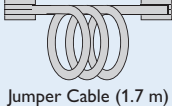
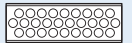
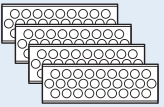
1 Choose housing type	2 Choose terminal housing and optional corners	3 Choose LED Module	4 Choose optional spread lens	5 Choose optional accessories		
<p>120 VAC or 277 VAC</p>  <p>Flanged 1 ft (.3 m) or 4 ft (1.2 m)</p>  <p>Flangeless 1 ft (.3 m) or 4 ft (1.2 m)</p>  <p>T-Bar 1 ft (.3 m) or 4 ft (1.2 m)</p>  <p>Slotted-T 1 ft (.3 m) or 4 ft (1.2 m)</p>	<p>220 – 240 VAC</p>  <p>Flanged 1 ft (.3 m) or 4 ft (1.2 m)</p>  <p>Flangeless 1 ft (.3 m) or 4 ft (1.2 m)</p>  <p>T-Bar 1 ft (.3 m) or 4 ft (1.2 m)</p>  <p>Slotted-T 1 ft (.3 m) or 4 ft (1.2 m)</p>	<p>Terminal</p>  <p>Joiner Plate (to terminate run)</p>  <p>Inside Corner</p>  <p>Outside Corner</p> 	<p>2700K 1 ft (.3 m) or 4 ft (1.2 m)</p>  <p>3000K 1 ft (.3 m) or 4 ft (1.2 m)</p>  <p>3500K 1 ft (.3 m) or 4 ft (1.2 m)</p>  <p>4000K 1 ft (.3 m) or 4 ft (1.2 m)</p> 	<p>10° x 60° 1 ft (.3 m) or 4 ft (1.2 m)</p>  <p>10° x 90° 1 ft (.3 m) or 4 ft (1.2 m)</p>  <p>30° x 30° 1 ft (.3 m) or 4 ft (1.2 m)</p>  <p>30° x 90° 1 ft (.3 m) or 4 ft (1.2 m)</p> 	<p>120 VAC / 277 VAC</p> <p>Leader Cable (10 ft)</p>  <p>Jumper Cable (1 ft)</p>  <p>Jumper Cable (4 ft)</p>  <p>Jumper Cable (8 ft)</p>  <p>Louver (1 ft / .3 m)</p>  <p>Louver Kit (4 ft / 1.2 m)</p> 	<p>220 – 240 VAC</p> <p>Leader Cable (3 m)</p>  <p>Jumper Cable (0.9 m)</p>  <p>Jumper Cable (1.4 m)</p>  <p>Jumper Cable (1.7 m)</p>  <p>Louver (1 ft / .3 m)</p>  <p>Louver Kit (4 ft / 1.2 m)</p> 

For 220—240 VAC installations, you must use leader and jumper cables.

For 120 / 277 VAC installations, you can either use leader and jumper cables or hardwire the fixtures. When hardwiring, the fixture acts as a junction box.

Housing and Terminal Options

Item	Style	Length	Voltage	Item Number	Philips 12NC
Housing	Flanged	300 mm	220–240 VAC	172-000073-27	910503704343
		1200 mm	220–240 VAC	172-000073-25	910503704341
		1 ft	120 / 277 VAC	172-000073-04	910503704174
		4 ft	120 VAC	172-000073-01	910503704171
	277 VAC		172-000073-13	910503704329	
	Flangeless	300 mm	220–240 VAC	172-000073-41	910503705012
		1200 mm	220–240 VAC	172-000073-43	910503705014
		1 ft	120 / 277 VAC	172-000073-05	910503704321
		4 ft	120 VAC	172-000073-02	910503704172
	277 VAC		172-000073-14	910503704330	
	T-Bar / Slotted-T	300 mm	220–240 VAC	172-000073-26	910503704342
		1200 mm	220–240 VAC	172-000073-24	910503704340
1 ft		120 / 277 VAC	172-000073-03	910503704173	
4 ft		120 VAC	172-000073-00	910503704170	
	277 VAC	172-000073-12	910503704328		
Inside 90° Corner	Flanged		172-000073-33	910503704357	
	Flangeless		172-000073-34	910503704358	
	T-Bar / Slotted-T		172-000073-32	910503704356	
Outside 90° Corner	Flanged		172-000073-36	910503704360	
	Flangeless		172-000073-37	910503704361	
	T-Bar / Slotted-T		172-000073-35	910503704359	
Terminal Housing	Flanged		172-000073-39	910503704989	
	Flangeless		172-000073-40	910503704990	
	T-Bar / Slotted-T		172-000073-38	910503704988	
Joiner Plate	Compatible with All Housing Versions			172-000073-63	912400133612

Use Item Number when ordering in North America.

LED Modules, Spread Lenses, and Louvers

Item	Length	Details	Item Number	Philips 12NC
LED Modules	.3 m / 1 ft	2700 K	523-000073-00	910503702652
	.3 m / 1 ft	3000 K	523-000073-02	910503702654
	.3 m / 1 ft	3500 K	523-000073-04	910503702656
	.3 m / 1 ft	4000 K	523-000073-06	910503702658
	1.2 m / 4 ft	2700 K	523-000073-01	910503702653
	1.2 m / 4 ft	3000 K	523-000073-03	910503702655
	1.2 m / 4 ft	3500 K	523-000073-05	910503702657
	1.2 m / 4 ft	4000 K	523-000073-07	910503702659
Spread Lens	.3 m / 1 ft	10° x 60°	120-000173-02	910503704574
	.3 m / 1 ft	10° x 90°	120-000173-01	910503704573
	.3 m / 1 ft	30° x 30°	120-000173-03	910503704575
	.3 m / 1 ft	30° x 60°	120-000173-04	910503704576
	1.2 m / 4 ft	10° x 60°	120-000173-07	910503704579
	1.2 m / 4 ft	10° x 90°	120-000173-14	912400130391
	1.2 m / 4 ft	30° x 30°	120-000173-08	910503704580
	1.2 m / 4 ft	30° x 60°	120-000173-09	910503704581
Louver	.3 m / 1 ft		120-000173-05	910503704577
	1.2 m / 4 ft		120-000173-13	910503705054

Use Item Number when ordering in North America.

Leader and Jumper Cables

Item	Length	Voltage	Item Number	Philips 12NC
Leader Cable	10 ft	120 / 277 VAC	108-000072-03	910503703135
	3 m	220–240 VAC	108-000072-13	910503705047
Jumper Cable	1 ft	120 / 277 VAC	108-000072-00	910503702835
	4 ft	120 / 277 VAC	108-000072-01	910503702836
	8 ft	120 / 277 VAC	108-000072-02	910503702837
	0.9 m	220–240 VAC	108-000072-15	910503705049
	1.4 m	220–240 VAC	108-000072-16	910503705050
	1.7 m	220–240 VAC	108-000072-17	910503705051

Use Item Number when ordering in North America.



Philips Color Kinetics
3 Burlington Woods Drive
Burlington, Massachusetts 01803 USA
Tel 888.385.5742
Tel 617.423.9999
Fax 617.423.9998
www.philipscolorkinetics.com

Copyright © 2014–2015 Philips Solid-State Lighting Solutions, Inc. All rights reserved. Chromacore, Chromasic, CK, the CK logo, Color Kinetics, the Color Kinetics logo, ColorBlast, ColorBlaze, ColorBurst, eW Fuse, ColorGraze, ColorPlay, ColorReach, iW Reach, eW Reach, DIMand, EssentialWhite, eW, iColor; iColor Cove, IntelliWhite, iW, iPlayer, Optibin, and Powercore are either registered trademarks or trademarks of Philips Solid-State Lighting Solutions, Inc. in the United States and / or other countries. All other brand or product names are trademarks or registered trademarks of their respective owners. Due to continuous improvements and innovations, specifications may change without notice. DAS-000125-13 R05 3-15