

Date: \_\_\_\_\_ Type: \_\_\_\_\_

Firm Name: \_\_\_\_\_

Project: \_\_\_\_\_

## SkyRibbon

### Essential White Wall Grazing Powercore, 2700 K, 10° × 10° native (no spread lens)

Recessed linear interior LED wall grazing fixture with solid white light

SkyRibbon Essential White Wall Grazing Powercore is a recessed linear interior LED wall grazing fixture offering high-quality, dimmable solid white light in four color temperatures, ranging from warm 2700 K to cool 4000 K. Brilliant light output and industry-leading color consistency make fixtures ideal for a variety of interior wall-grazing applications. Multiple housing options accommodate a number of installation methods.

- Four color temperatures — Solid white light LED modules available in 2700 K, 3000 K, 3500 K, and 4000 K color temperatures, supporting a broad selection of design objectives.
  - High-quality illumination in a variety of beam angles — Native 10° × 10° beam angle. Holographic diffusion lenses offer additional 10° × 60°, 10° × 90°, 30° × 30°, and 30° × 60° beam angle options for design flexibility.
  - Multiple housing options for installation and mounting flexibility — T-Bar, Slotted-T, Flanged, and Flangeless housings support numerous installation methods and appearances.
  - Flexible configuration — Available in 300 mm (1 ft) and 1200 mm (4 ft) fixture lengths with multiple jumper cables, corners, terminals, and connector options to accommodate nearly any layout.
- Integrates patented Powercore technology — Powercore rapidly, efficiently, and accurately controls power output to fixtures directly from line voltage, eliminating the need for an external power supply.
  - Dimming capability — Patented DIMand technology offers smooth dimming capability with selected commercially available reverse-phase ELV-type dimmers.
  - Optibin advanced binning algorithm — Exceeds the recognized standards for color quality to guarantee uniformity and color consistency across LED sources, fixtures, and manufacturing runs.
  - Three voltage options — Available 120 VAC, 220 – 240 VAC, and 277 VAC fixtures ensure consistent operation worldwide.

For detailed product information, please refer to SkyRibbon Essential White Wall Grazing Powercore Product Guide at [www.philipscolorkinetics.com/ls/ew/skyribbon-wall-grazing/](http://www.philipscolorkinetics.com/ls/ew/skyribbon-wall-grazing/)

# PHILIPS

# CE Dimensional Diagrams

## SkyRibbon Wall Grazing Powercore Flanged Housing, 220 – 240 VAC

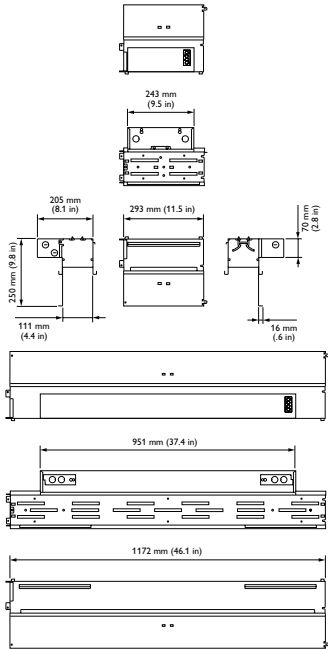

## SkyRibbon Wall Grazing Powercore Flangeless Housing, 220 – 240 VAC

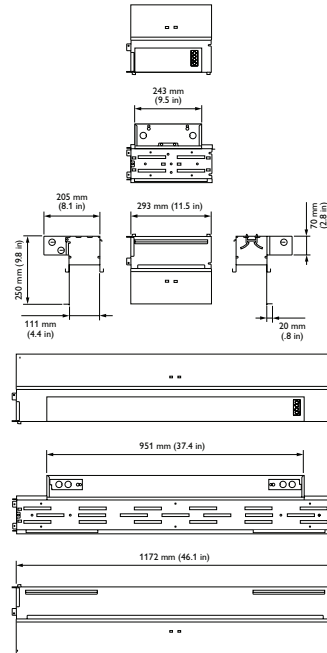

## SkyRibbon Wall Grazing Powercore T-Bar / Slotted-T Housing, 220 – 240 VAC

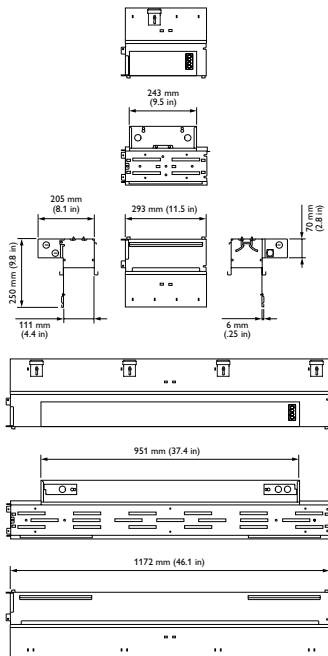

# UL Dimensional Diagrams

## SkyRibbon Wall Grazing Powercore Flanged Housing, 120 / 277 VAC

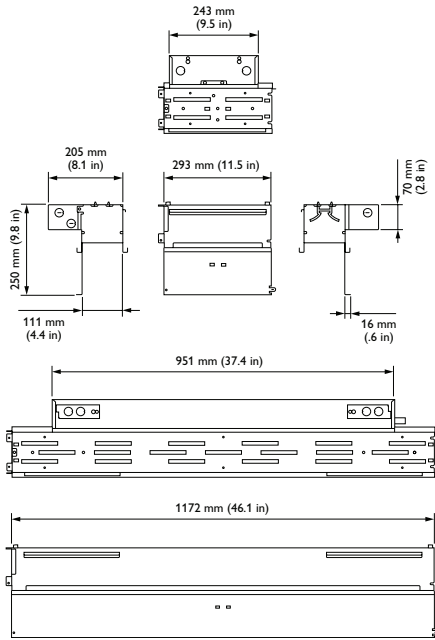

## SkyRibbon Wall Grazing Powercore Flangeless Housing, 120 / 277 VAC

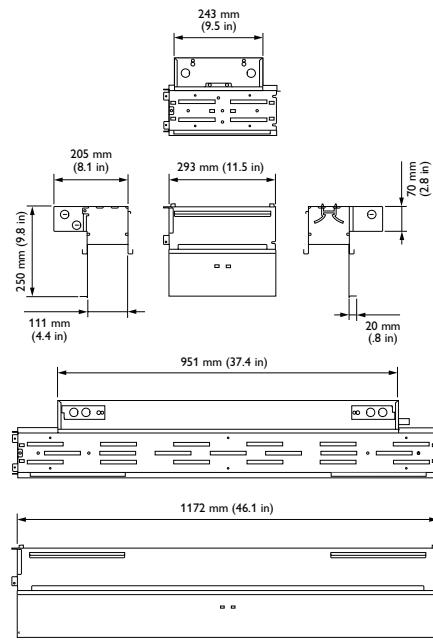

## SkyRibbon Wall Grazing Powercore T-Bar / Slotted-T Housing, 120 / 277 VAC

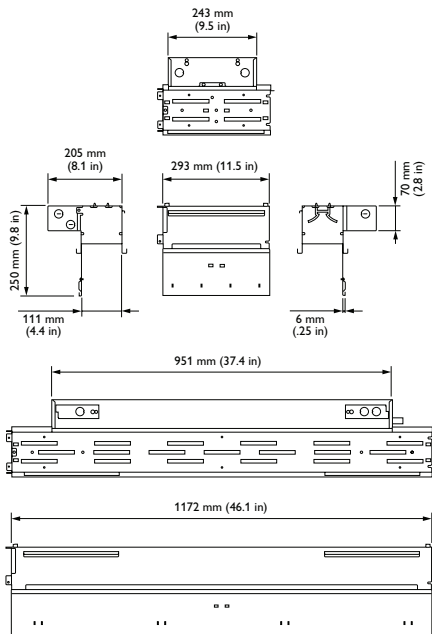

# Photometrics / SkyRibbon Essential White Wall Grazing Powercore, 2700 K, 10° x 10° spread lens, 3 m (1 ft)

Photometric data is based on test results from an independent NIST traceable testing lab. IES data is available at [www.philipscolorkinetics.com/support/ies](http://www.philipscolorkinetics.com/support/ies).

Lumens	Efficacy
966	59.6 lm / W

## Polar Candela Distribution

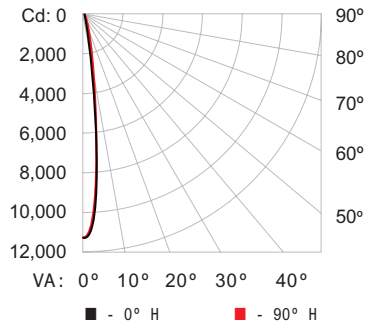

	0	25	45	70	90
0	11180	11180	11180	11180	11180
5	7423	7540	7801	7962	7735
15	404	417	480	552	560
25	133	132	132	123	120
35	121	121	123	117	107
45	96	98	98	97	84
55	70	70	69	65	56
65	48	49	47	42	33
75	21	23	25	23	14
85	17	16	14	8	2
90	16	15	12	6	1

## Illuminance at Distance

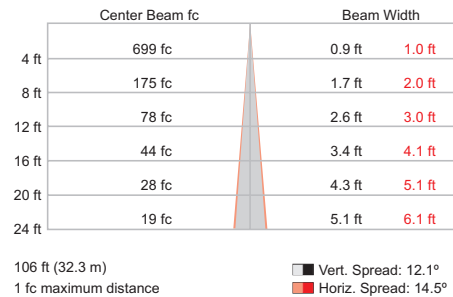

## Coefficients Of Utilization - Zonal Cavity Method

Effective Floor Cavity Reflectance: 20%

RCC %:	80	70	50	30	10	0													
RW %:	70	50	30	0	70	50	30	0											
RCR:	0	119	119	119	119	116	116	116	99	110	110	110	106	106	106	101	101	101	99
	1	114	111	109	107	111	109	107	94	105	103	102	101	100	98	97	96	95	94
	2	109	105	102	99	107	103	100	90	100	97	95	97	95	93	94	92	91	89
	3	105	100	96	92	103	99	95	86	96	93	90	93	91	89	91	89	87	86
	4	102	96	91	88	100	95	90	84	92	89	86	90	87	85	88	86	84	83
	5	99	92	88	84	97	91	87	81	89	86	83	88	85	82	86	84	81	80
	6	96	89	85	81	95	88	84	79	87	83	80	86	82	80	84	81	79	78
	7	93	87	82	79	92	86	82	77	85	81	78	84	80	78	82	80	77	76
	8	91	84	80	77	90	84	80	76	83	79	77	82	79	76	81	78	76	75
	9	89	82	78	75	88	82	78	74	81	77	75	80	77	75	79	77	74	73
	10	87	81	77	74	87	80	76	73	80	76	74	79	76	73	78	75	73	72

## Zonal Lumen

Zone	Lumens	% Fixture
0 - 60	904.7	93.6 %
60 - 90	50.3	5.2 %
0 - 90	955.0	98.8 %
90 - 180	11.4	1.2 %
0 - 180	966.4	100 %

For lux multiply fc by 10.7

# Specifications / SkyRibbon Essential White Wall Grazing Powercore, 2700 K, 10° x 10° spread lens, .3 (1 ft)

Due to continuous improvements and innovations, specifications may change without notice

Item	Specification	Details
Output	Lumens*	966
	Efficacy (lm / W)	59.6
	CRI	83
	Power Factor	.99 @ 120 VAC
	Color Temperature†	2700 K
	Lumen Maintenance‡	76,000 hours L70 @ 25° C 50,000 hours L70 @ 40° C 100,000 hours L50 @ 25° C 80,000 hours L50 @ 40° C
Electrical	Input Voltage	120 VAC, 220 – 240 VAC, 277 VAC, 50 / 60 Hz
	Power Consumption	16 W (0.3 m / 1ft 120 VAC) 60 W (1.2 m / 4ft 120 VAC) 17 W (0.3 m / 1ft 220 – 240 / 277 VAC) 60 W (1.2 m / 4ft 220 – 240 / 277 VAC)
Control	Dimming	Compatible with selected commercially available reverse-phase ELV-type dimmers§
Physical	Housing Material	Steel, white powder-coated finish
	Lens	Polycarbonate
	Fixture Connections	178 mm (7 in) flying leads, integral male / female connectors (120 / 277 VAC) Wieland integral male / female connectors (220 – 240 VAC)
	Temperature Ranges	-20° – 40° C (-4° – 104° F) Operating -20° – 40° C (-4° – 104° F) Startup -40° – 80° C (-40° – 176° F) Storage
	Fixture Run Lengths	To calculate fixture run lengths and total power consumption for your specific installation, download the Configuration Calculator from <a href="http://www.philipscolorkinetics.com/support/install_tool/">www.philipscolorkinetics.com/support/install_tool/</a>
	Humidity	0 – 95%, non-condensing
Certification and Safety	Certification	UL / cUL, FCC Class A, CE
	Environment	Dry / Damp Location, IP20

\* Lumen measurement complies with IES LM-79-08 testing procedures.

† Color temperatures conform to nominal CCTs as defined in ANSI Chromaticity Standard C78.377A.

‡ L70 = 70% lumen maintenance (when light output drops below 70% of initial output).

L50 = 50% lumen maintenance (when light output drops below 50% of initial output). Ambient luminaire temperatures specified. Lumen maintenance calculations are based on lifetime prediction graphs supplied by LED source manufacturers. Calculations for white-light LED fixtures are based on measurements that comply with IES LM-80-08 testing procedures. Refer to [www.philipscolorkinetics.com/support/appnotes/lm-80-08.pdf](http://www.philipscolorkinetics.com/support/appnotes/lm-80-08.pdf) for more information.

§ Refer to [www.philipscolorkinetics.com/support/appnotes/](http://www.philipscolorkinetics.com/support/appnotes/) for specific details.





## Dimensions and Weight

Fixture	Physical Characteristics	T-Bar / Slotted-T	Flanged	Flangeless
.3 m (1 ft)	Housing Dimensions <i>Height x Width x Depth</i>	251 x 293 x 205 mm (9.9 x 11.5 x 8.1 in)	251 x 293 x 205 mm (9.9 x 11.5 x 8.1 in)	251 x 293 x 205 mm (9.9 x 11.5 x 8.1 in)
	Assembled Weight†	3.3 kg (7.3 lbs)	3.3 kg (7.3 lbs)	3.3 kg (7.3 lbs)
1.2 m (4 ft)	Housing Dimensions <i>Height x Width x Depth</i>	251 x 1172 x 205 mm (9.9 x 46.1 x 8.1 in)	251 x 1172 x 205 mm (9.9 x 46.1 x 8.1 in)	251 x 1172 x 205 mm (9.9 x 46.1 x 8.1 in)
	Assembled Weight†	10.5 kg (23.1 lb)	10.5 kg (23.1 lb)	10.5 kg (23.1 lb)

† Assembled weight includes fixture housing and LED module.

# Product Selection

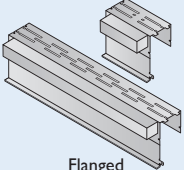
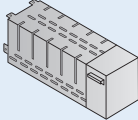
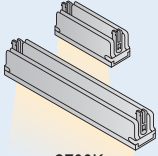
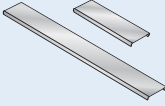
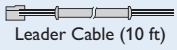
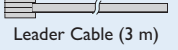
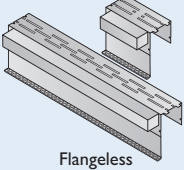
To order a complete SkyRibbon Essential White Wall Grazing Powercore fixture, choose a housing (voltage, length, and type), an LED module, a spread lens, a Leader Cable, and optional Jumper Cables and louvers.

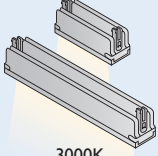
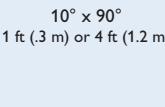
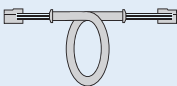
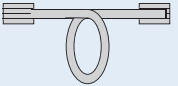
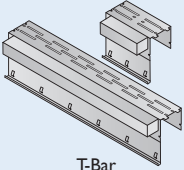
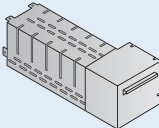
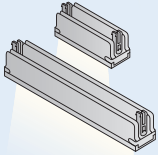
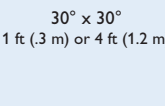
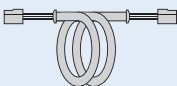
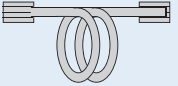
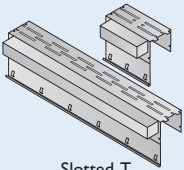
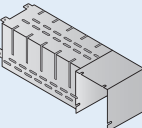
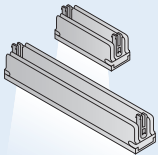
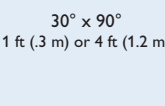
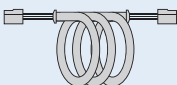
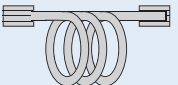
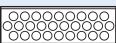
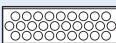
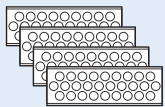
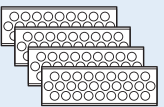
1 Choose housing type		2 Choose terminal housing and optional corners		3 Choose LED Module		4 Choose optional spread lens		5 Choose optional accessories			
<b>120 VAC or 277 VAC</b>  Flanged 1 ft (.3 m) or 4 ft (1.2 m)		 Terminal		 2700K 1 ft (.3 m) or 4 ft (1.2 m)		 10° x 60° 1 ft (.3 m) or 4 ft (1.2 m)		<b>120 VAC / 277 VAC</b>  Leader Cable (10 ft)		<b>220 – 240 VAC</b>  Leader Cable (3 m)	
 Flangeless 1 ft (.3 m) or 4 ft (1.2 m)		 Joiner Plate (to terminate run)		 3000K 1 ft (.3 m) or 4 ft (1.2 m)		 10° x 90° 1 ft (.3 m) or 4 ft (1.2 m)		 Jumper Cable (1 ft)		 Jumper Cable (0.9 m)	
 T-Bar 1 ft (.3 m) or 4 ft (1.2 m)		 Inside Corner		 3500K 1 ft (.3 m) or 4 ft (1.2 m)		 30° x 30° 1 ft (.3 m) or 4 ft (1.2 m)		 Jumper Cable (4 ft)		 Jumper Cable (1.4 m)	
 Slotted-T 1 ft (.3 m) or 4 ft (1.2 m)		 Outside Corner		 4000K 1 ft (.3 m) or 4 ft (1.2 m)		 30° x 90° 1 ft (.3 m) or 4 ft (1.2 m)		 Jumper Cable (8 ft)		 Jumper Cable (1.7 m)	
								 Louver (1 ft / .3 m)		 Louver (1 ft / .3 m)	
								 Louver Kit (4 ft / 1.2 m)		 Louver Kit (4 ft / 1.2 m)	

For 220—240 VAC installations, you must use leader and jumper cables.

For 120 / 277 VAC installations, you can either use leader and jumper cables or hardwire the fixtures. When hardwiring, the fixture acts as a junction box.

## Housing and Terminal Options

Item	Style	Length	Voltage	Item Number	Philips 12NC
Housing	Flanged	300 mm	220–240 VAC	172-000073-27	910503704343
		1200 mm	220–240 VAC	172-000073-25	910503704341
		1 ft	120 / 277 VAC	172-000073-04	910503704174
		4 ft	120 VAC	172-000073-01	910503704171
	277 VAC		172-000073-13	910503704329	
	Flangeless	300 mm	220–240 VAC	172-000073-41	910503705012
		1200 mm	220–240 VAC	172-000073-43	910503705014
		1 ft	120 / 277 VAC	172-000073-05	910503704321
		4 ft	120 VAC	172-000073-02	910503704172
	277 VAC		172-000073-14	910503704330	
	T-Bar / Slotted-T	300 mm	220–240 VAC	172-000073-26	910503704342
		1200 mm	220–240 VAC	172-000073-24	910503704340
1 ft		120 / 277 VAC	172-000073-03	910503704173	
4 ft		120 VAC	172-000073-00	910503704170	
	277 VAC	172-000073-12	910503704328		
Inside 90° Corner	Flanged			172-000073-33	910503704357
	Flangeless			172-000073-34	910503704358
	T-Bar / Slotted-T			172-000073-32	910503704356
Outside 90° Corner	Flanged			172-000073-36	910503704360
	Flangeless			172-000073-37	910503704361
	T-Bar / Slotted-T			172-000073-35	910503704359
Terminal Housing	Flanged			172-000073-39	910503704989
	Flangeless			172-000073-40	910503704990
	T-Bar / Slotted-T			172-000073-38	910503704988
Joiner Plate	Compatible with All Housing Versions			172-000073-63	912400133612

Use Item Number when ordering in North America.

## LED Modules, Spread Lenses, and Louvers

Item	Length	Details	Item Number	Philips 12NC
LED Modules	.3 m / 1 ft	2700 K	523-000073-00	910503702652
	.3 m / 1 ft	3000 K	523-000073-02	910503702654
	.3 m / 1 ft	3500 K	523-000073-04	910503702656
	.3 m / 1 ft	4000 K	523-000073-06	910503702658
	1.2 m / 4 ft	2700 K	523-000073-01	910503702653
	1.2 m / 4 ft	3000 K	523-000073-03	910503702655
	1.2 m / 4 ft	3500 K	523-000073-05	910503702657
	1.2 m / 4 ft	4000 K	523-000073-07	910503702659
Spread Lens	.3 m / 1 ft	10° x 60°	120-000173-02	910503704574
	.3 m / 1 ft	10° x 90°	120-000173-01	910503704573
	.3 m / 1 ft	30° x 30°	120-000173-03	910503704575
	.3 m / 1 ft	30° x 60°	120-000173-04	910503704576
	1.2 m / 4 ft	10° x 60°	120-000173-07	910503704579
	1.2 m / 4 ft	10° x 90°	120-000173-14	912400130391
	1.2 m / 4 ft	30° x 30°	120-000173-08	910503704580
	1.2 m / 4 ft	30° x 60°	120-000173-09	910503704581
Louver	.3 m / 1 ft		120-000173-05	910503704577
	1.2 m / 4 ft		120-000173-13	910503705054

Use Item Number when ordering in North America.

## Leader and Jumper Cables

Item	Length	Voltage	Item Number	Philips 12NC
Leader Cable	3 m	220–240 VAC	108-000072-13	910503703135
	10 ft	120 / 277 VAC	108-000072-03	910503703135
Jumper Cable	0.9 m	220–240 VAC	108-000072-15	910503705049
	1.4 m	220–240 VAC	108-000072-16	910503705050
	1.7 m	220–240 VAC	108-000072-17	910503705051
	1 ft	120 / 277 VAC	108-000072-00	910503702835
	4 ft	120 / 277 VAC	108-000072-01	910503702836
	8 ft	120 / 277 VAC	108-000072-02	910503702837

Use Item Number when ordering in North America.





Philips Color Kinetics  
3 Burlington Woods Drive  
Burlington, Massachusetts 01803 USA  
Tel 888.385.5742  
Tel 617.423.9999  
Fax 617.423.9998  
[www.philipscolorkinetics.com](http://www.philipscolorkinetics.com)

Copyright © 2014–2015 Philips Solid-State Lighting Solutions, Inc. All rights reserved. Chromacore, Chromasic, CK, the CK logo, Color Kinetics, the Color Kinetics logo, ColorBlast, ColorBlaze, ColorBurst, eW Fuse, ColorGraze, ColorPlay, ColorReach, iW Reach, eW Reach, DIMand, EssentialWhite, eW, iColor; iColor Cove, IntelliWhite, iW, iPlayer, Optibin, and Powercore are either registered trademarks or trademarks of Philips Solid-State Lighting Solutions, Inc. in the United States and / or other countries. All other brand or product names are trademarks or registered trademarks of their respective owners. Due to continuous improvements and innovations, specifications may change without notice. DAS-000125-01 R04 3-15