



Date: _____ Type: _____

Firm Name: _____

Project: _____

PDS-60ca 24V Pre-programmed

Power / data supply for indoor and outdoor applications

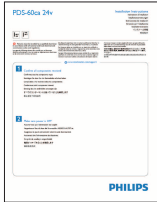

For device mounting and maintenance details, refer to the Installation Instructions included in the product packaging, or download documentation from www.philipscolorkinetics.com/ls/pds/pds60ca24/

PDS-60ca 24 V Pre-programmed is a versatile power / data supply designed for indoor and outdoor LED lighting fixtures employing Chromasic technology from Philips Color Kinetics.

PDS-60ca 24 V Pre-programmed features built-in visual effects, allowing configurations without Ethernet or DMX controllers.

In runs with multiple power / data supplies, PDS-60ca 24 V Pre-programmed functions as a master control unit, delivering data to the other power / data supplies in the run. Use one PDS-60ca 24 V Pre-programmed unit per run, and standard PDS-60 24 V DMX units for all additional power / data supplies.

PDS-60ca 24 V Pre-programmed delivers 62 watts of power output and automatically accommodates input voltages ranging from 100 VAC to 240 VAC.

Short-circuit protection prevents device failure due to incorrectly wired fixtures.

Featuring a NEMA 4 (IP66) enclosure, PDS-60ca 24 V Pre-programmed installs in dry, damp, and wet locations.

PDS-60ca Pre-programmed 24 V offers multiple standard-size conduit entries to accommodate 1/2 in (13 mm) and 3/4 in (19 mm) trade-sized conduit.

Compatible Fixtures

Fixture	Max. Quantity Per PDS-60ca 24V
eW Flex SLX	1 string
iColor Flex LMX	1 string
iColor Cove EC 7 in	30
iColor Cove EC 12 in	30
iColor Cove QLX 6 in	30
iColor Cove QLX 12 in	20

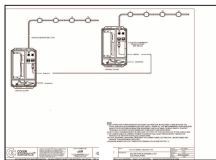

PDS-60ca Pre-programmed wiring diagrams are available online at www.philipscolorkinetics.com/support/wiring/

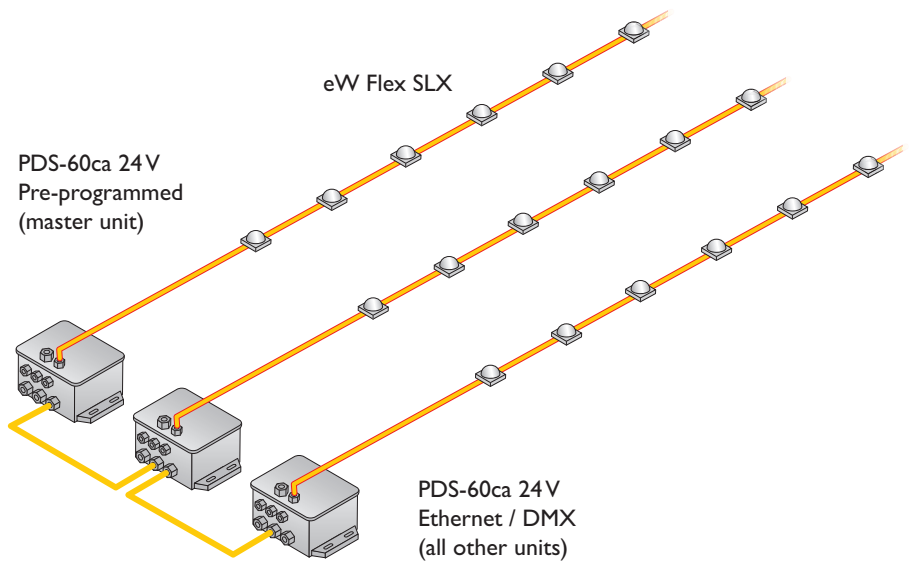

Specifications

Due to continuous improvements and innovations, specifications may change without notice.

Item	Specification	Details	
Electrical	Input Voltage	100 – 240 VAC, auto-switching, 50 / 60 Hz	
	Maximum Input Current	1.7 A at 100 VAC, 1.5 A at 120 VAC, .75 A at 240 VAC	
	Power Output	24 VDC, 62 W maximum	
	Fuse Rating	(2) 4 A, 5 x 20 fast blow fuses	
Physical	Dimensions (Height x Width x Depth)	3.6 x 5.5 x 8.8 in (91 x 140 x 224 mm)	
	Weight	4.5 lb (2.0 kg)	
	Construction	Cast aluminum enclosure with slots for surface mounting	
	Finish	Gray matte	
	Connectors	Data	RJ45 connector
		Power Output	(2) 4-pin output receptacles
		Power Input	Line-neutral-ground cable, flying leads
	Temperature Ranges	14° – 104° F (-10° – 40° C) Operating 14° – 122° F (-10° – 50° C) Startup -40° – 176° F (-40° – 80° C) Storage	
	Humidity	0 – 95%, non-condensing	
	Cooling	Convection	
Heat Dissipation	25% of total power input at maximum load		
Data Input Source	Internal		
Certification and Safety	Certification	UL / cUL, PSE	
	Classification	UL Class 2 power supply	
	Environment	Dry / Damp / Wet Location, IP66	

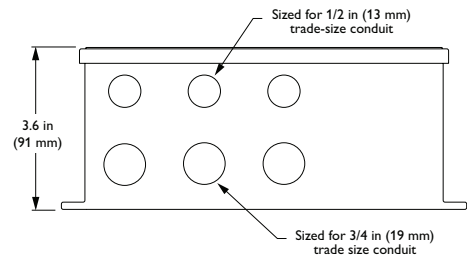
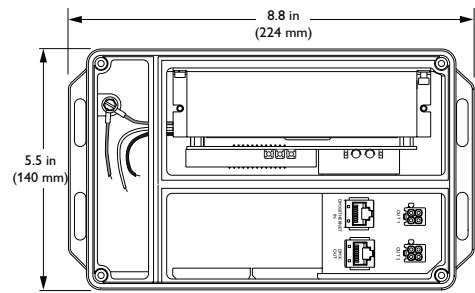

Overall Dimensions

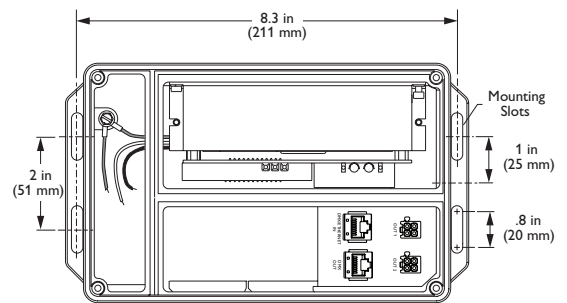

Mounting Dimensions

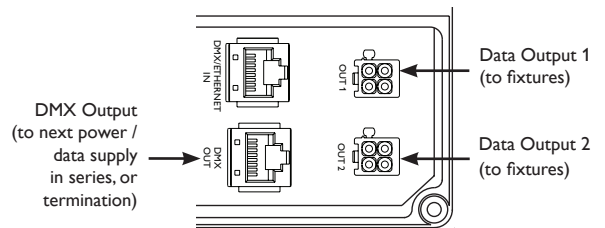

Ordering Information

Item	Included Components	Item Number	Philips 12NC
PDS-60ca 24V Pre-programmed	Power / data supply, (3) EMI suppression cores, (2) spare fuses, (8) NPT threaded seal plugs, and Installation Instructions	109-000016-00	910503700095

Use Item Number when ordering in North America.

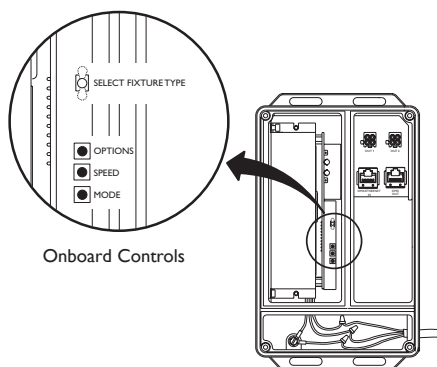

Onboard Controls

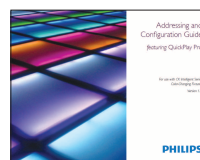

For complete instructions on setting pre-programmed effects via onboard controls, refer to the *Addressing and Configuration Guide* available online at: www.philipscolorkinetics.com/support/addressing/



Philips Color Kinetics
3 Burlington Woods Drive
Burlington, Massachusetts 01803 USA
Tel 888.385.5742
Tel 617.423.9999
Fax 617.423.9998
www.philipscolorkinetics.com

Copyright © 2009 – 2012 Philips Solid-State Lighting Solutions, Inc. All rights reserved. Chromacore, Chromasic, CK, the CK logo, Color Kinetics, the Color Kinetics logo, ColorBlast, ColorBlaze, ColorBurst, eW Fuse, ColorGraze, ColorPlay, ColorReach, iW Reach, eW Reach, DIMand, EssentialWhite, eW, iColor, iColor Cove, IntelliWhite, iW, iPlayer, Optibin, and Powercore are either registered trademarks or trademarks of Philips Solid-State Lighting Solutions, Inc. in the United States and / or other countries. All other brand or product names are trademarks or registered trademarks of their respective owners. Due to continuous improvements and innovations, specifications may change without notice. DAS-000060-07 R02 04-12