



ColorBlaze Upgrade Kit

RGBW / RGBA upgrade for ColorBlaze industry-standard theatrical and rental LED batten



ColorBlaze Upgrade Kit

RGBW / RGBA upgrade for ColorBlaze industry-standard theatrical and rental LED battens

The ColorBlaze Upgrade Kit retrofits any ColorBlaze 48 or ColorBlaze 72 fixture to four-channel RGBW or RGBA operation. Expanded on-board controls feature a range of new functions, including multiple color control modes, 8- and 16-bit resolution, a configurable intensity channel, transition speeds, dimming curves, improved color consistency with Chromasync technology, and three built-in effects (Fixed Color, Color Wash, and Chasing Rainbow).

- Versatile, intense light output — Upgraded fixtures provide nearly double the lumen output. Controllable in increments of 152 mm (6 in) to 1.8 m (6 ft), fixtures deliver stunning effects and intense washes of color for flooding surfaces and stages.
- Expanded color palettes — Channels of amber or neutral white LEDs seamlessly blend with channels of red, green, and blue LEDs to produce significantly expanded color palettes. In addition to the millions of saturated colors achievable with standard RGB lighting fixtures, RGBW fixtures provide high-quality white light, while RGBA fixtures create intense yellows and an extended range of subtle pastel colors.
- Flexible color control — Choose from four-channel RGBW or RGBA in / out and three-channel RGB in mapped to four-channel RGBW or RGBA out.
- Superior color consistency and accuracy — Optibin, an advanced binning algorithm, sets a new standard for the color consistency and uniformity of LED sources used in manufacturing. Chromasync technology achieves unprecedented consistency of light performance and color precision across multiple fixtures in an installation, while maximizing intensity and color range.
- Adjustable dimming curves and transition speeds — 16-bit resolution supports smooth dimming and precise color control. Adjustable dimming curves and LED transition speeds emulate the behavior of other Philips Color Kinetics fixtures and conventional theatrical fixtures with DMX dimming.
- Pushbutton addressing and configuration — Onboard addressing offers easy configuration without external addressing tools.
- Built-in effects — Offers Fixed Color, Color Wash, and Chasing Rainbow effects, without the need for an external controller.



Upgrade Kit Components

The Upgrade Kit contains LED boards, a fan, a controller board, mounting hardware and jumper cables.

Photometrics

Photometric data is based on test results from an independent NIST traceable testing lab. IES data is available at www.philipscolorkinetics.com/support/ies.

ColorBlaze 48 with Upgrade Kit, RGBW, 10° Beam Angle

Lumens	Efficacy
8023	36.4 lm / W

Polar Candela Distribution

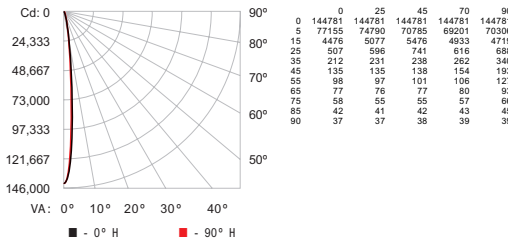

Illuminance at Distance

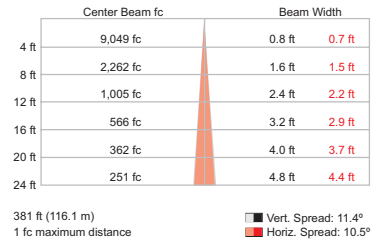

Zonal Lumen

Zone	Lumens	% Fixture
0 - 60	7837.7	97.7 %
60 - 90	185.8	2.3 %
0 - 90	8023.4	100 %

For lux multiply fc by 10.7

Coefficients Of Utilization - Zonal Cavity Method

		Effective Floor Cavity Reflectance: 20%																	
RCC %:		80		70		50		30		10		0							
RW %:		70	50	30	0	70	50	30	0	50	30	20	50	30	20	0			
RCR: 0		119	119	119	119	116	116	116	100	111	111	111	106	106	106	102	102	102	100
1		115	113	112	110	113	111	110	97	107	106	105	104	103	102	100	100	99	97
2		112	109	106	104	110	107	105	95	104	102	100	101	100	98	99	97	96	95
3		109	105	102	100	108	104	101	94	102	99	97	99	97	96	97	96	94	93
4		107	102	99	96	105	101	98	92	99	97	95	98	95	94	96	94	93	92
5		105	100	96	94	103	99	96	91	97	95	93	96	94	92	95	93	91	90
6		103	98	94	92	102	97	94	90	96	93	91	95	92	90	93	91	90	89
7		101	96	92	90	100	95	92	88	94	91	89	93	91	89	92	90	89	88
8		99	94	91	89	99	94	91	87	93	90	88	92	90	88	91	89	88	87
9		98	93	90	87	97	92	89	87	92	89	87	91	89	87	90	88	87	86
10		97	91	88	86	96	91	88	86	91	88	86	90	88	86	89	87	86	85

ColorBlaze 72 with Upgrade Kit, RGBW, 18° Beam Angle

Lumens	Efficacy
8460	38.3 lm / W

Polar Candela Distribution

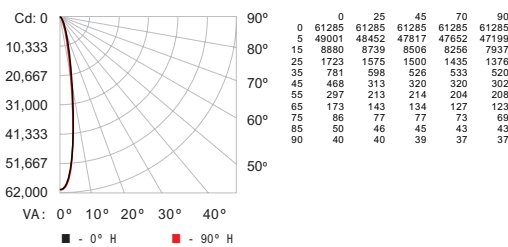

Illuminance at Distance

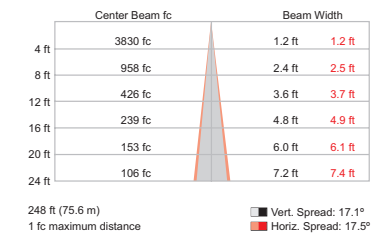

Zonal Lumen

Zone	Lumens	% Fixture
0 - 60	8183.5	96.7 %
60 - 90	276.7	3.3 %
0 - 90	8460.2	100 %

For lux multiply fc by 10.7

Coefficients Of Utilization - Zonal Cavity Method

		Effective Floor Cavity Reflectance: 20%																	
RCC %:		80		70		50		30		10		0							
RW %:		70	50	30	0	70	50	30	0	50	30	20	50	30	20	0			
RCR: 0		119	119	119	119	116	116	116	100	111	111	111	106	106	106	102	102	102	100
1		114	112	110	108	112	110	108	96	106	104	103	102	101	100	99	98	97	95
2		110	106	103	100	108	105	102	92	101	99	97	99	97	95	96	94	93	91
3		106	101	97	94	105	100	96	89	98	95	92	95	93	91	93	91	89	88
4		103	97	93	90	101	96	92	86	94	91	88	92	89	87	91	88	86	85
5		100	94	89	86	98	93	89	83	91	88	85	90	87	84	88	86	84	82
6		97	91	86	83	96	90	86	81	88	85	82	87	84	82	86	83	81	80
7		94	88	83	80	93	87	83	79	86	82	80	85	82	79	84	81	79	78
8		92	85	81	78	91	85	81	77	84	80	78	83	80	77	82	79	77	76
9		90	83	79	76	89	83	79	75	82	78	76	81	78	76	80	77	75	74
10		88	81	77	74	87	81	77	74	80	77	74	79	76	74	79	76	74	73

Photometrics

Photometric data is based on test results from an independent NIST traceable testing lab. IES data is available at www.philipscolorkinetics.com/support/ies.

ColorBlaze 48 with Upgrade Kit, RGBA, 10° Beam Angle

Lumens	Efficacy
7805	35.2 lm / W

Polar Candela Distribution

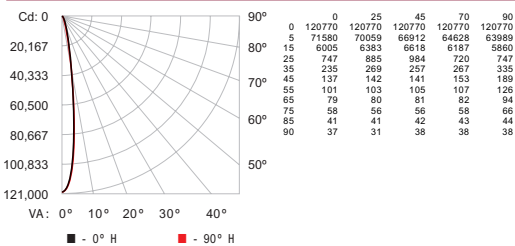

Illuminance at Distance

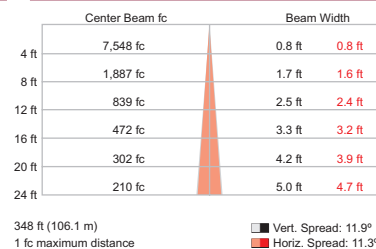

Zonal Lumen

Zone	Lumens	% Fixture
0 - 60	7619.9	97.6 %
60 - 90	185.2	2.4 %
0 - 90	7805.0	100 %

Coefficients Of Utilization - Zonal Cavity Method

Effective Floor Cavity Reflectance: 20%

RCC %:	80	70	50	30	20	10	0												
RW %:	70	50	30	0	70	50	30	0	50	30	20	50	30	20	0				
RCR:	0	119	119	119	119	116	116	116	100	111	111	111	106	106	106	102	102	102	100
1	115	113	111	110	113	111	109	97	107	106	105	103	102	102	100	99	99	97	97
2	112	108	106	103	110	107	104	95	104	102	100	101	99	98	98	97	96	94	94
3	109	105	101	99	107	103	100	93	101	98	96	99	97	95	97	95	94	92	92
4	106	101	98	95	105	100	97	91	99	96	94	97	94	93	95	93	92	91	91
5	104	99	95	93	103	98	95	90	96	94	91	95	93	91	94	92	90	89	89
6	102	97	93	90	101	96	93	88	95	92	90	93	91	89	92	90	88	88	88
7	100	94	91	89	99	94	91	87	93	90	88	92	89	88	91	89	87	86	86
8	98	93	89	87	97	92	89	86	91	89	86	91	88	86	90	88	86	85	85
9	97	91	88	86	96	91	88	85	90	87	85	89	87	85	89	86	85	84	84
10	95	90	86	84	94	89	86	84	89	86	84	88	86	84	88	85	84	83	83

For lux multiply fc by 10.7

ColorBlaze 72 with Upgrade Kit, RGBA, 18° Beam Angle

Lumens	Efficacy
7888	35.6 lm / W

Polar Candela Distribution

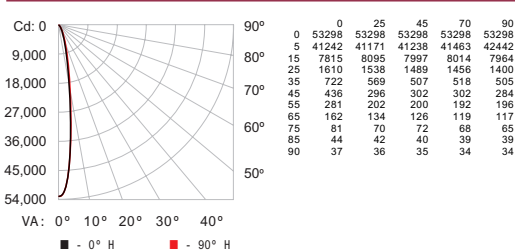

Illuminance at Distance

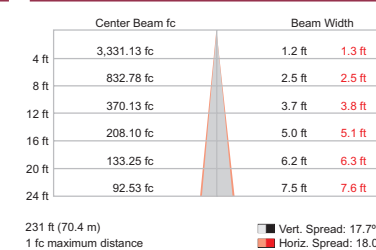

Zonal Lumen

Zone	Lumens	% Fixture
0 - 60	7627.0	96.7 %
60 - 90	260.7	3.3 %
0 - 90	7887.7	100 %

Coefficients Of Utilization - Zonal Cavity Method

Effective Floor Cavity Reflectance: 20%

RCC %:	80	70	50	30	20	10	0												
RW %:	70	50	30	0	70	50	30	0	50	30	20	50	30	20	0				
RCR:	0	119	119	119	119	116	116	116	100	111	111	111	106	106	106	102	102	102	100
1	114	112	110	108	112	110	108	96	106	104	103	102	101	100	99	98	97	95	95
2	110	106	103	100	108	104	101	92	101	99	97	98	96	95	96	94	93	91	91
3	106	101	97	94	104	100	96	88	97	94	92	95	92	90	93	91	89	88	88
4	103	97	92	89	101	96	92	85	94	90	88	92	89	87	90	88	86	84	84
5	99	93	89	85	98	92	88	83	91	87	84	89	86	84	88	85	83	82	82
6	97	90	85	82	95	89	85	80	88	84	81	87	83	81	85	83	80	79	79
7	94	87	83	80	93	86	82	78	85	82	79	84	81	79	83	80	78	77	77
8	91	85	80	77	90	84	80	76	83	79	77	82	79	76	81	78	76	75	75
9	89	82	78	75	88	82	78	74	81	77	75	80	77	75	80	77	74	73	73
10	87	80	76	73	86	80	76	73	79	76	73	78	75	73	78	75	73	72	72

For lux multiply fc by 10.7

Specifications

Due to continuous improvements and innovations, specifications may change without notice.

Item	Specification	ColorBlaze 48 Upgrade Kit	ColorBlaze 72 Upgrade Kit	
Output	Beam Angle	10° / 18°		
	Lumens*	RGBW	8023 (10°) 8460 (18°)	12034 (10°) 12690 (18°)
		RGBA	7805 (10°) 7888 (18°)	11707 (10°) 11832 (18°)
	LED Channels	Red / Green / Blue / White or Amber		
	Lumen Maintenance†	71,000 hours L70 @ 50° C		71,000 hours L70 @ 25° C
71,000 hours L50 @ 50° C		74,000 hours L50 @ 25° C		
Electrical	Input Voltage	100 – 240 VAC, auto-switching, 50 / 60 Hz		
	Power Consumption	280 W	420 W	
Control	Interface	DMX		
	Control System	Philips full range of controllers, including Light System Manager, ColorDial Pro, and iPlayer 3, or third-party controllers		
Physical	Dimensions (Height x Width x Depth)	191 x 1150 x 165 mm (7.5 x 45.3 x 6.5 in)	191 x 1746 x 165 mm (7.5 x 68.7 x 6.5 in)	
	Weight (fixture with Upgrade Kit)	14.1 kg (31 lb)	20 kg (44 lb)	
	Housing	Extruded aluminium, black finish		
	Lens	Clear polycarbonate		
	Fixture Connections	IEC power cable, RJ45, Ethercon, or XLR-5 data connections		
	Temperature Ranges	-40° – 50° C (-40° – 122° F) Operating		-20° – 50° C (-4° – 122° F) Startup
		-40° – 80° C (-40° – 176° F) Storage		
Humidity	0 – 95%, non-condensing			
Certification and Safety	Certification	UL / cUL, CE, FCC Class A		
	Environment	Dry Location, IP20		

* Lumen measurement complies with IES LM-79-08.

† L70 = 70% lumen maintenance (when light output drops below 70% of initial output).

L50 = 50% lumen maintenance (when light output drops below 50% of initial output). Ambient luminaire temperatures specified. Lumen maintenance calculations are based on lifetime prediction graphs supplied by LED source manufacturers. Calculations for white-light LED fixtures are based on measurements that comply with IES LM-80-08 testing procedures. Refer to www.philipscolorkinetics.com/support/appnotes/lm-80-08.pdf for more information

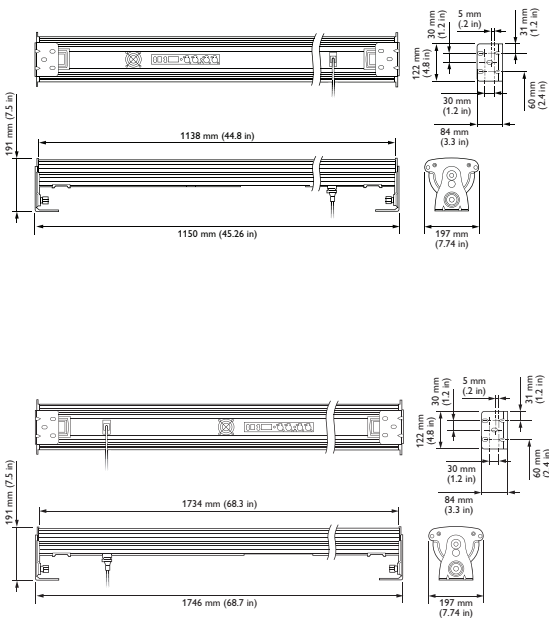

CHROMACORE[®] | OPTIBIN[®] | CHROMASYNC[®]
CKTECHNOLOGY | CKTECHNOLOGY | CKTECHNOLOGY

ColorBlaze Upgrade Kit

Fixture	Type	Beam Angle	Item Number	Philips 12NC
ColorBlaze 48 Upgrade Kit	RGBW	10°	116-000037-01	910503704726
		18°	116-000035-01	910503704678
	RGBA	10°	116-000037-00	910503704724
		18°	116-000035-00	910503704677
ColorBlaze 72 Upgrade Kit	RGBW	10°	116-000038-01	910503704727
		18°	116-000036-01	910503704680
	RGBA	10°	116-000038-00	910503704725
		18°	116-000036-00	910503704679

Use Item Number when ordering in North America.

Installation

The ColorBlaze Upgrade Kit contains a controller board, LED boards, a fan, mounting hardware, and jumper cables. When the upgrade is complete, a ColorBlaze fixture offers a new set of onboard menus and functions that are not available on standard ColorBlaze fixtures. Refer to relevant sections this product guide for information associated with operating and testing the upgraded fixture.

Install the Upgrade Kit

Refer to the *ColorBlaze 48, 72 Upgrade Kit Installation Instructions* for detailed installation instructions.

 Refer to the *ColorBlaze 48, 72 Upgrade Kit Installation Instructions* for specific warning and caution statements.

Owner / User Responsibilities

It is the responsibility of the contractor, installer, purchaser, owner, and user to install, maintain, and operate ColorBlaze fixtures in such a manner as to comply with all applicable codes, state and local laws, ordinances, and regulations. Consult with the appropriate electrical inspector to ensure compliance.

Create a Lighting Design Plan

Regardless of the details of your installation, it's good practice to create a lighting design plan that identifies your fixtures, records the DMX addresses assigned to them, and identifies their locations in relation to other required hardware. For complex installations displaying light shows with dynamic effects, such a lighting design plan is essential.

To create a lighting design plan, determine the appropriate location of each ColorBlaze fixture in relation to power sources and controllers. On an architectural diagram or other diagram that shows the physical layout of the installation, identify the locations of all controllers, fixtures, power sources, and cables. To streamline installation and aid in light show programming, you can affix a label identifying the order or placement in the installation to an inconspicuous location on each ColorBlaze fixture's housing.

Keep the following considerations in mind when planning your installation:

- The integrated, auto-switching power supply automatically adjusts to any 50 / 60 Hz power source from 110 – 240 V. Each ColorBlaze fixture includes a 6 ft (1.8 m) detachable cable with a standard IEC connector and flying leads. You must connect the cable's flying leads to a 3-wire plug appropriate for your geographic location.
- You can connect ColorBlaze fixtures in series using any combination of RJ45, Ethercon, and XLR-5 data cables.
- ColorBlaze fixtures can work as a single unit, or you can set fixtures to have multiple segments that display different colors simultaneously for dynamic effects. Segment lengths differ depending on fixture length and configuration. When installing fixtures end-to-end, you can create virtual segments that span multiple fixtures.
- You can mix ColorBlaze 48 and ColorBlaze 72 fixtures in a single run. A mixture of fixture lengths can offer flexibility in architectural applications where you need to install fixtures around corners or in confined areas.
- You can mount ColorBlaze fixtures end-to-end, or you can space them however you wish, so long as the maximum distance from a controller to the last fixture in a series does not exceed 300 m (1000 ft) without a DMX repeater.
- Each series of fixtures can use up to 512 unique DMX addresses. Since each upgraded fixture segment requires four addresses, you can have up to 128

uniquely addressed segments within a single series. For example, you could create a series of 10 upgraded ColorBlaze 72 fixtures, each with 12 segments (10 fixtures x 12 segments x 4 = 480 addresses), or a series of 64 upgraded ColorBlaze 48 fixtures, each with 2 segments (64 fixtures x 2 segments x 4 = 512 addresses).

✳ If you use a cable other than the included IEC power cable, make sure that the cable is equivalent in size and rating, and that it meets local standards. Ensure that the plug on the power cable can be held securely in place by the IEC inlet locking mechanism, which is designed for a C13 plug.

Connect the Power Cable Plug

ColorBlaze has integrated, auto-switching power supplies that automatically adjust to any 50 / 60 Hz power source from 110 – 240 V. ColorBlaze fixtures are connected directly to line power using the included 6 ft (1.8 m) detachable power cable. You must connect the cable's flying leads to an appropriate 3-wire plug.

1. Connect the power cable to the IEC inlet on the back of the ColorBlaze housing.

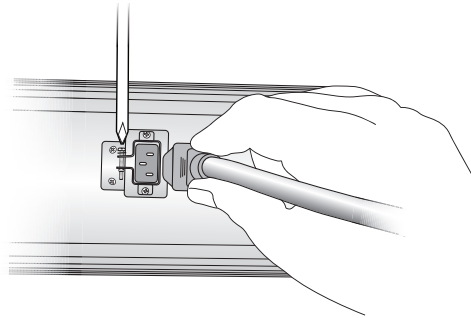

2. Tighten the screw on the IEC inlet to hold the power cable in place.

Address and Configure Fixtures

A DMX universe consists of 512 channels or addresses. The number of uniquely addressed fixtures in a DMX universe is determined by how the lighting fixtures are configured. For example, a DMX universe can support 170 uniquely addressed three-channel fixtures (512 divided by 3, with 2 channels remaining). A DMX universe can also support 128 four-channel fixtures (512 divided by 4). A lighting installation can consist of one or more DMX universes.

ColorBlaze fixtures use sequential DMX addresses. Each fixture consumes from 3 to 120 DMX addresses, depending on color control mode (3-channel or 4-channel), fixture resolution (8-bit or 16-bit), fixture length, segment size (ranging from 152 mm (6 in) to the total fixture length), and whether the intensity channel is enabled or disabled.

In 8-bit mode, each segment uses one DMX address per channel, while in 16-bit mode each segment uses two DMX addresses per channel, one for coarse control and one for fine control. The coarse channel offers 256 values, while the fine channel adds 256 additional values to each coarse channel value, resulting in a total of 65,536 individual steps or settings (256 x 256).

ColorBlaze fixtures can be configured to use an additional intensity channel. Enabling the intensity channel lets you adjust the brightness of all LED channels proportionally using a fader on a DMX console. For example, you can set a desired color, then adjust the brightness with the assigned fader while maintaining the color value.

When you enable the intensity channel, each ColorBlaze node consumes an additional DMX address in 8-bit mode and two additional DMX addresses in 16-bit mode. Make sure that your addressing scheme accounts for the additional DMX addresses that the intensity channel requires.

Channels Per Segment

RGB in / out and RGB -> RGBW or RGBA							Intensity Channel Enabled	
8-Bit Mode	1 Red		2 Green		3 Blue		4 Intensity	
	16-Bit Mode	1 Red Coarse	2 Red Fine	3 Green Coarse	4 Green Fine	5 Blue Coarse	6 Blue Fine	7 Intensity Coarse

RGBW or RGBA in / out									Intensity Channel Enabled	
8-Bit Mode	1 Red		2 Green		3 Blue		4 White or Amber		5 Intensity	
	16-Bit Mode	1 Red Coarse	2 Red Fine	3 Green Coarse	4 Green Fine	5 Blue Coarse	6 Blue Fine	7 Coarse	8 Fine	9 Intensity Coarse

Keep the following considerations in mind when addressing ColorBlaze fixtures:

- Each fixture is factory-addressed to a starting DMX address of 1.
- With the back of the fixture housing toward you, segments extend in sequence from the left of the fixture to the right.
- ColorBlaze onboard addressing automatically assigns consecutive DMX addresses to the fixture's segments, starting with the channel you set.
- Make sure that the DMX start channel allows enough DMX addresses for all of the fixture's segments, or the fixture will not function properly. For example, in 8-bit mode, a 4-channel fixture with 4 groups requires 16 DMX addresses, 4 per segment. Therefore, the DMX start channel should be 496 or lower.
- For light shows with dynamic effects, set start channels so that each fixture in a series receives a unique set of DMX addresses. For example, in a series of 3 fixtures operating in 8-bit mode, where each fixture has 4 groups, you can ensure each fixture is uniquely addressed by setting the start channel of the first fixture to 1, the start channel of the second fixture to 17 (1 + 16), and the start channel of the third fixture to 33 (17 + 16).
- The number of DMX addresses per segment, added to the starting DMX address, determines the next unique address in a sequence. The following table lists the number of DMX addresses you should add to your starting DMX address in order to determine the next unique address in a DMX universe. When determining unique DMX addresses for your lighting system, refer to the following table.

Configuration	DMX Addresses Per Segment
RGB 8-bit	3
RGB + Intensity 8-bit	4
RGB 16-Bit	6
RGB + Intensity 16-Bit	8
RGBW or RGBA 8-bit	4
RGBW or RGBA + Intensity 8-bit	5
RGBW or RGBA 16-bit	8
RGBW or RGBA + Intensity 16-bit	10

For example, if you configure ColorBlaze RGBW fixtures to 16-bit mode, with the intensity channel active, then the configuration must include 10 DMX addresses per segment. This configuration allows for up to 51 uniquely addressed fixtures (512 divided by 10, with two channels remaining). As shown in the following table, if the starting DMX address for the first segments is 1, the second segment would be 11, the third segment 21, etc.

ColorBlaze 72 RGBW / RGBA Plus Intensity Channel, 16-Bit, Start Channel = 1

		DMX Start Channel Per Segment											
1 group		Segment 1 001											
2 groups		Segment 1 001						Segment 2 011					
3 groups		Segment 1 001				Segment 2 011				Segment 3 021			
4 groups		Segment 1 001			Segment 2 011			Segment 3 021			Segment 4 031		
6 groups		Segment 1 001		Segment 2 011		Segment 3 021		Segment 4 031		Segment 5 041		Segment 6 051	
A (12) groups		Seg 1 001	Seg 2 011	Seg 3 021	Seg 4 031	Seg 5 041	Seg 6 051	Seg 7 061	Seg 8 071	Seg 9 081	Seg 10 091	Seg 11 101	Seg 12 111

Set Fixture Segments

Make sure the power is ON before addressing and configuring fixtures by plugging in the fixture's power cable.

To allow a fine level of control for light shows with dynamic effects, ColorBlaze fixtures can be configured to have multiple individually addressable groups of fixture segments: 1, 2, 4, or 8 for ColorBlaze 48, or 1, 2, 3, 4, 6, or 12 for ColorBlaze 72. You set the fixture's start DMX address, and the onboard controls automatically assign unique DMX addresses to each segment.

Each fixture is factory-addressed to have 1 group and a starting DMX address of 1. For light show designs displaying static effects, no changes to the factory-default settings are necessary. However, if fixtures were previously configured for use in other installations, you may have to reset them. For light show designs with dynamic effects, you may need to set the number of groups each fixture will have.

► To set the number of groups for a ColorBlaze fixture:

1. Plug in the fixture's power cable and make sure the power is ON.
2. In the NUMBER OF GROUPS section on the back of the fixture housing, press the + and - buttons to scroll through the menu options: 1, 2, 4, or A (8) for ColorBlaze 48 fixtures, or 1, 2, 3, 4, 6, or A (12) for ColorBlaze 72 fixtures.
3. For complex installations where you set different numbers of groups on different fixtures, it's good practice to notate each fixture's group setting on the lighting design plan.

Keep the following considerations in mind when setting the number of fixture groups:

- The number of groups effectively determines segment length. For example, setting a ColorBlaze 48 fixture to 4 groups results in 4 segments of roughly 1 foot each. Setting a ColorBlaze 72 fixture to 3 groups results in 3 segments of roughly 2 feet each. The following table gives the segment lengths for the different settings available on each fixture.

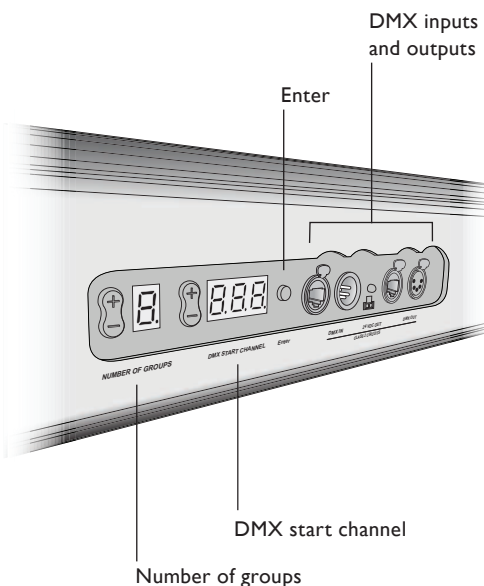

Number of Groups Settings

Segment Length	ColorBlaze 48	ColorBlaze 72
1.8 m (6 ft)	—	1
1.2 m (4 ft)	1	—
0.9 m (3 ft)	—	2
0.6 m (2 ft)	2	3
0.46 m (1.5 ft)	—	4
0.3 m (1 ft)	4	6
0.15 m (.5 ft)	A (8)	A (12)

- As the table shows, you can mix ColorBlaze 48 and ColorBlaze 72 fixtures in the same series while maintaining consistent segment lengths of 2 feet, 1 foot, or .5 feet.

610 mm (2 ft)
segments

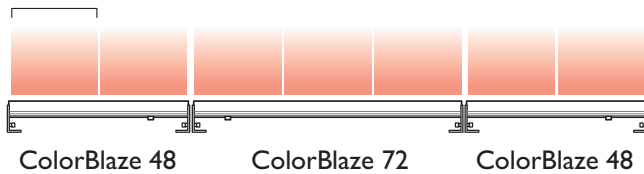

- If you install fixtures end to end, you can create virtual segments that span multiple fixtures. For example, you can create virtual 8 ft segments by alternating 3-segment and 2-segment fixtures.

2.74 m (9 ft) segments



Set the DMX Start Address

Each ColorBlaze fixture is factory-addressed to a starting DMX address of 1. For pre-configured light show designs displaying static effects, no changes to the factory-default settings are necessary. However, if fixtures were previously readdressed for use in other installations, you may have to reset them to the same starting DMX address. For light show designs displaying dynamic effects, you must set a different starting channel for each fixture in the series to ensure that all fixture segments are uniquely addressed.

► To set a fixture's DMX start channel:

- On the back of the fixture, press the Enter button to activate the onboard menu.
- In the DMX START CHANNEL section on the back of the fixture housing, press the + and - buttons to scroll through all available DMX addresses (1 – 512).
- If you're enabling dynamic effects by setting different DMX starting channels for each fixture in a series, you can streamline configuration and light show programming by notating the DMX starting channel of each fixture segment on the lighting design plan.

Set Channel Mode

When operating ColorBlaze fixtures, select the channel mode for the lighting effects in your application: 3-3, 3-4, or 4-4.

3-3 Configuration: The 3-to-3 configuration allows legacy RGB light shows to be carried over to four-channel lighting fixtures; however, the fourth channel (White or Amber) remains off. Therefore, this configuration does not use the full color palette available on four-channel ColorBlaze fixtures.

3-4 Configuration: The 3-to-4 configuration works with controllers that employ three output data channels. This configuration maps three channels of control data to all four LED channels. This option turns Chromasync on.

4-4 Configuration: The 4-to-4 configuration works with controllers that deliver four channels of control data to four-channel LED fixtures. This is the default setting for the fixture.

► To set channel mode:

1. On the back of the fixture, press the Enter button until Channel Mode (CHL) appears in the digital display.
2. Hold the Enter button momentarily, then use the + and - buttons to select the channel mode.

Turn Chromasync On or Off

With Chromasync, the unique gamut (color range) of LED lighting fixtures in a family is defined using a calibrated light measurement device during manufacturing. Calibration information is stored on each fixture, along with Chromasync color consistency algorithms. When Chromasync is turned on, each fixture's on-board logic automatically adjusts all fixtures in an installation to a common gamut. With all fixtures using the same gamut, color consistency is greatly improved, eliminating the need to manually adjust the color points of each fixture using controller or configuration software.

► To turn Chromasync on or off:

1. On the back of the fixture, press the Enter button until Chromasync (Chr) appears in the digital display.
2. Hold the Enter button momentarily, then use the + and - buttons to turn Chromasync on or off.

Set Fixture Resolution

Upgraded fixtures can function in 8-bit or 16-bit mode. 16-bit mode affords finer control over channel intensity and color selection. In 16-bit mode, each fixture segment consumes twice as many consecutive DMX addresses.

► To set fixture resolution:

1. On the back of the fixture, press the Enter button until Fixture Resolution (b · t) appears in the digital display.
2. Hold the Enter button, then use the + and - buttons to select either 8-bit or 16-bit resolution.

Set Dimming Curve

A dimming curve describes how slowly or quickly a fixture dims at different levels of input. For finer control, ColorBlaze offers three different dimming curves for use in different situations and applications: Normal, Tungsten, and Linear.

Normal: The non-linear (gamma) dimming curve used in most Philips Color Kinetics LED lighting fixtures. Use this dimming curve to achieve consistent dimming behavior in an installation where ColorBlaze is installed alongside other Philips Color Kinetics lighting fixtures.

Tungsten: A non-linear dimming curve that emulates the dimming curve of incandescent lamps on a DMX dimmer. This curve offers the most control at low intensities.

Linear: A dimming curve with a linear relationship between DMX input and LED power.

► To set dimming curve:

1. On the back of the fixture, press the Enter button until Dimming Curve (C U r) appears in the digital display.
2. Hold the Enter button momentarily, then use the + and - buttons to select normal (n O r), tungsten (L U n), or linear (L I n) as the dimming curve.

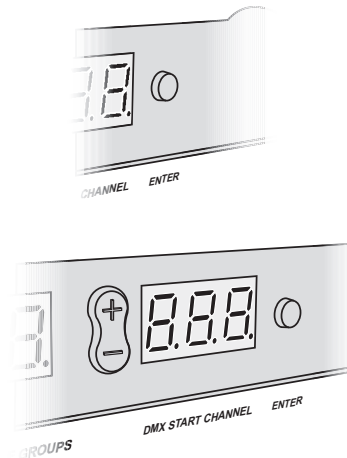

Set Transition Speed

Normally, LEDs react to DMX or other control data instantaneously. You may want to slow down the reaction speed for smoother transitions when the intensity of LED channels change. ColorBlaze offers five levels of decreasing LED transition speed.

► To set transition speed:

1. On the back of the fixture, press the Enter button until Transition Speed (S P d) appears in the digital display.
2. Hold the Enter button momentarily, then use the + and - buttons to select the transition delay: d 1 (fastest delay), d 2, d 3, d 4 (slowest delay), or o F F as the LED transition speed.

Turn Intensity Channel On or Off

Enabling the intensity channel lets you adjust the intensity of all LED channels proportionally using one slider on a DMX console. For example, you can set a color that you want, then adjust the intensity with the assigned slider while maintaining the color value. When the intensity channel is enabled, an additional bit to each DMX address that is used to control pixel intensity.

► To turn intensity channel on or off:

1. On the back of the fixture, press the Enter button until Intensity Channel (I n L) appears in the digital display.
2. Hold the Enter button momentarily, then use the + and - buttons to set the intensity channel on or off.

Reverse Segment Order

Normal segment order is from input side to output side (right to left facing the front of the fixture). Reverse segment order is from output side to input side (left to right).

► **To reverse segment order:**

1. On the back of the fixture, press the Enter button until Reverse Segment Order (rSα) appears in the digital display.
2. Hold the Enter button momentarily, then use the + and - buttons to set reverse segment order as on or off.

Configure Built-In Lighting Effects

Upgraded fixtures offer three built-in lighting effects: fixed color, color wash, and chasing rainbow. You can change the properties of each built-in show to produce a desired effect.

Fixed Color

Fixed Color displays a single solid color simultaneously on all fixtures in a group. You can select the color and adjust the intensity of the fixture.

Fixed Color Values

Produce the following colors using the corresponding values.

Color	Value
Red	0
Green	512
Blue	1024

► **To configure Fixed Color properties:**

1. On the back of the fixture, press the Enter button until Fixed Color (FCL) appears in the digital display.
2. Press and momentarily hold the Enter button to select the color to display. Use the + and - buttons until the fixture produces the color you want (0 to 1535).
3. Press the Enter button to select the fixture intensity. Use the + and - buttons to increase or decrease the intensity (0 to 255).

Color Wash

The Color Wash effect creates a smooth transition through a series of solid colors on all segments simultaneously. The transition of color progresses from red through yellow, green, blue, and then back to red.

► **To configure Color Wash properties:**

1. On the back of the fixture, press the Enter button until Color Wash (CLW) appears in the digital display.
2. Press and hold the Enter button to set the duration (in seconds) for the effect to cycle through the range of colors once. Increase or decrease the duration value using the + and - buttons (0 to 3600).
3. Press the Enter button to select the fixture intensity. Use the + and - buttons to increase or decrease the intensity (0 to 255).

Chasing Rainbow

The chasing effect creates segments of color moving or “chasing” each other in one direction. You can select the duration, or time it takes the fixture to cycle through the colors one time, and the intensity of the fixture.

► **To configure Chasing Rainbow properties:**

1. On the back of the fixture, press the Enter button until Chasing Rainbow (CHR) appears in the digital display.
2. Hold the Enter button to set the duration (in seconds) for the fixture to cycle through the colors one time. Increase or decrease the duration value using the + and - button (0 to 3600).
3. Press the Enter button to select the intensity. Use the + and - buttons to increase or decrease the intensity (0 to 255).

Test the Fixture

ColorBlaze fixtures contain basic utilities you can use to test the product.

Test Mode

The test mode turns all LEDs full on, providing a basic functionality check. Additionally, you can use the test mode to cycle through the solid colors.

► To enter test mode:

1. On the back of the fixture, press the Enter button until Test Mode (Tst) appears in the digital display.
2. Hold the Enter button momentarily, until End appears in the digital display. All LED channels should be on, and the fixture produces warm white light.
3. Using both sets of the + and - buttons, verify the output of the fixed colored lights: blue, amber, green, and red.
4. Press Enter to exit the test mode.

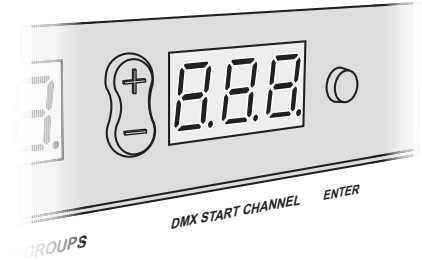

Restore Factory Defaults

You can easily restore a fixture's factory default settings.

► To restore factory defaults:

1. On the back of the fixture, press the Enter button until Default (dEF) appears in the digital display.
2. Hold the Enter button momentarily, and use the + and - buttons to select yes.
3. Press and release the Enter button. The fixture resets to its default settings.



Philips Color Kinetics
3 Burlington Woods Drive
Burlington, Massachusetts 01803 USA
Tel 888.385.5742
Tel 617.423.9999
Fax 617.423.9998
www.philipscolorkinetics.com

Copyright © 2014 Philips Solid-State Lighting Solutions, Inc. All rights reserved.
Chromacore, Chromasic, CK, the CK logo, Color Kinetics, the Color Kinetics logo, ColorBlast, ColorBlaze TR4, ColorBurst, eW Fuse, ColorGraze, ColorPlay, ColorReach, iW Reach, eW Reach, DIMand, EssentialWhite, eW, iColor, iColor Cove, IntelliWhite, iW, iPlayer, Optibin, and Powercore are either registered trademarks or trademarks of Philips Solid-State Lighting Solutions, Inc. in the United States and / or other countries. All other brand or product names are trademarks or registered trademarks of their respective owners. Due to continuous improvements and innovations, specifications may change without notice.
Cover Photo: Courtesy of Mark Thomas Productions, Ltd. DAS-000132-00 R00 1-14